

COTECH®

SEALING PRODUCTS

Gaskets • Dichtungen • Joints • Juntas • Guarnizioni

100%
PREMIUM
— Quality —

NON ASBESTOS



High Quality Gasket



CITROEN-FIAT-HONDA-HYUNDAI-JOHNDERE-LADA
MITSUBISHI -OPEL-PERKINS-PEUGEOT-RENAULT
SKODA -VOLKSWAGEN-VOLVO

➔ www.cotechgasket.com

I.O.S.B Çevre Sanayi Sitesi 5 Blok
No:6 İkitelli - Başakşehir / İSTANBUL/TURKEY

Tel: +90 212 485 89 02 Pbx Fax: +90 212 485 89 03
info@cotechgasket.com

En gelişmiş üretim teknolojilerinin kullanıldığı **COTECH**, çok geniş bir marka ve model yelpazesinde sürdürdüğü üretimine, her geçen gün yeni marka ve model ailelerini ekleyerek, birlikte çalıştığı firmaların da ihtiyaçlarını eksiksiz karşılamak ve piyasada rekabet şanslarını en yüksek seviyede tutmayı hedefleyerek desteklemektedir.

COTECH, kurulduğu ilk günden bugüne sahip olduğu ve hiç bir surette ödün vermediği prensipler olan kaliteli ürün koşulsuz müşteri memnuniyetine yönelik prensipleri ile hizmetine devam etmekten gurur ve mutluluk duymaktadır.

Ürettiği ürünlerin yanısıra marka olarak her zaman tercih edilmiş olan **COTECH**, sahip olduğu **ISO 9001: 2000** kalite standartlarına uygunluk belgesi ile ürünlerinin kalitesini belgelendirmiştir.

COTECH, ürünlerinin siparişten başlayarak hazırlık, üretim, paketlenme, depolama ve sevkiyat aşamalarında kontrol ve takibi dünya çapında tescilli barkodlar ile yürütmektedir.

Yıllık olarak gerçekleştirdiği üretiminin %30'u iç piyasada alıcı bulurken, %70'i ise yurt dışı pazarda satışa sunulmaktadır.

COTECH; gelişim ve yeniliklere açıklık ilkesine, yarım asıra yaklaşan bilgi birikimi ve tecrübesini de ekleyerek üretimde çağın gerektirdiği şartları yerine getirmiştir.



COTECH is manufacturing auto gaskets for wide range of brands and model families with the latest manufacturing technology and always adding new brands and model families to their products to fulfill the market with the highest rate of competition opportunity.

COTECH feels the proud of to follow up and to protect two principles since the first day;

- Production and Service Quality
- Complete Customer Saticfastion

COTECH holds **ISO 9001: 2000** Quality Assurance Cetificate for their products and their products and their brand that always preferred in the mrket trustfully.

COTECH uses worldwide registered barcodes during all steps of manufacturing, packaging, storage and product flow.

30% of annual production of **COTECH** is sold in domestic market and 70% of annual production purchased in foreing market.

COTECH is keeping on it's production with the experience of development as a part of it's principles that form the genuine of the company.

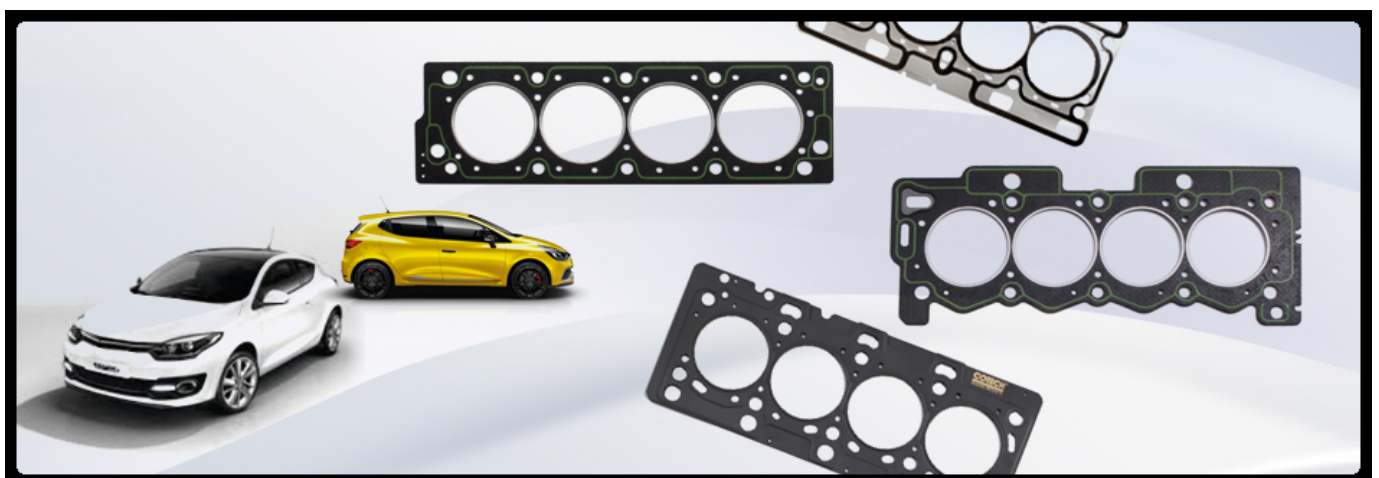

Silindir Kapak Contaları:

Silindir kapak conta, silindir kafası ve blok arasına yerleştirilmiştir. Isı, mekanik ve kimyasal etkenlere direnç gösterir. Conta çeşitli sıcaklıklar arasında kusursuz sızdırmazlık gerektirir. Contanın montajı esnasında contaya herhangi bir zarar verilmemeli ve tork anahtarı ile fabrikanın önerdiği derecede sıkma işlemi gerçekleştirilmelidir.

Cylinder Head Gasket:

Situated between the cylinder head and the block, the cylinder head gasket is punished by increasingly greater stresses: thermal, mechanical and chemical. It must ensure a flawless seal across a wide range of temperatures, despite being tightened with a limited torque setting so as not to damage or weaken the cylinder head and at the same time withstand the inevitable movements between cylinder head and block.

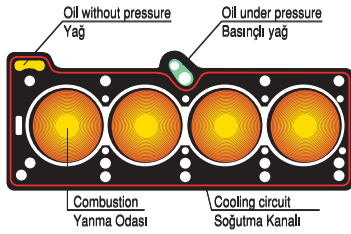

	Sıcaklık / Temperature (°C)	Basınç / Pressure (bars)
Sıkıştırılmış gazlar / Combustion gases	> 1000	70 - 160 (TDI)
Yağ / Oil	-30 - 150	0 - 7
Su (antifriz) / Water (cooling liquid)	-30 - 110	0.5 - 1.5

Dizel ve Turbo Dizel Araçlar:

Dizel ve turbo dizel motorlarda yüksek sıkıştırma oranlarından dolayı, conta malzemesi son derece önem taşımaktadır. Pistonlar motor bloğunun üstüne kadar geçer ve pistonlar daha düz ve subaplar pistonlarla sürtünmeyecek şekilde tasarlanmıştır. Bu sebepten ötürü conta kalınlıkları resimde görüldüğü gibi son derece önemlidir.

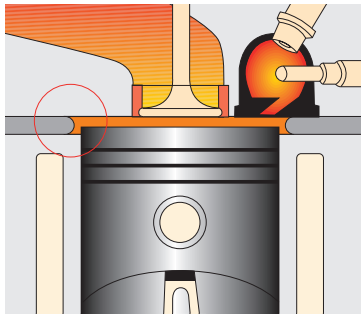

Benzinli Araçlar:

Dizel araçlara göre sıkıştırma oranları ve torklar daha düşüktür. Fakat yine dizel araçlarda olduğu gibi basınca ve yüksek ısıya karşı sızdırmazlığı koruyacak malzemeler kullanılmalıdır. Günümüzde otomobil üreticileri sızdırmazlığı sağlamak amacıyla motorlarda Multi Layer Steel (MLS) contalar kullanmaktadır.

Diesel and Turbo Diesel Vehicles :

Gasket material is of utmost importance in diesel and turbo diesel engines because of the high compressing ratios. Pistons pass beyond the engine block and pistons are designed as more flat and valves are designed in a way that they will not have friction with pistons. For this reason, as seen in the picture, gasket thicknesses are very important.

Gasoline Vehicles :

Compression ratios and torques are less with respect to diesel vehicles. But still materials that will maintain sealing against compression must be used. Nowadays car drivers use Multi Layer Steel (MLS) gaskets in engines in order to provide sealing.

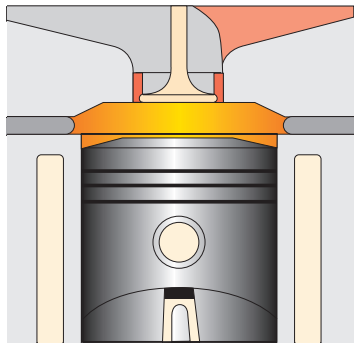

Multi Layer Steel (MLS) Kapak Contaları

Birçok araç üreticisi artık orijinal donatım olarak Multi Layer Steel (çok katlı çelik) silindir kapak contalarını geliştirmiştir.

Bu ürünler, daha yüksek silindir basınçları ve modern motorlarda, ısı ve basınçla başa çıkabilmek amacıyla tasarlanmıştır. **COTECH**, gelişmiş tasarım sızdırmazlık materyalleri kullanarak, uygulamaları karşılayabilmek için en geniş Multi Layer Steel conta yelpazesini geliştirmiştir.

COTECH MLS Özel Kapak Contaları çelik üç katmandan oluşmaktadır. **COTECH**, basınca karşı doğal dayanımına ek güç olarak çelik kullanmaktadır.

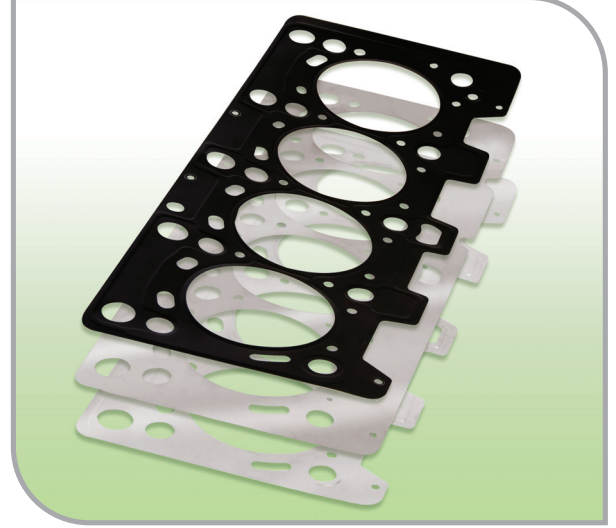

Multi Layer Steel (MLS) Head Gaskets.

Many vehicle manufacturers are now fitting Multi Layer steel cylinder head gaskets, as original equipment.

*These are designed to cope with higher cylinder pressures and thermal stresses in modern engines. **COTECH** has developed the widest range of Multi Layer steel gaskets to meet the demand for European and Asiatic applications using the latest design sealing system.*

COTECH MLS Custom Head Gaskets are comprised of three layers of stainless steel. **COTECH** use stainless steel for added strength it's ability to rebound and it's natural resistance to corrosion.



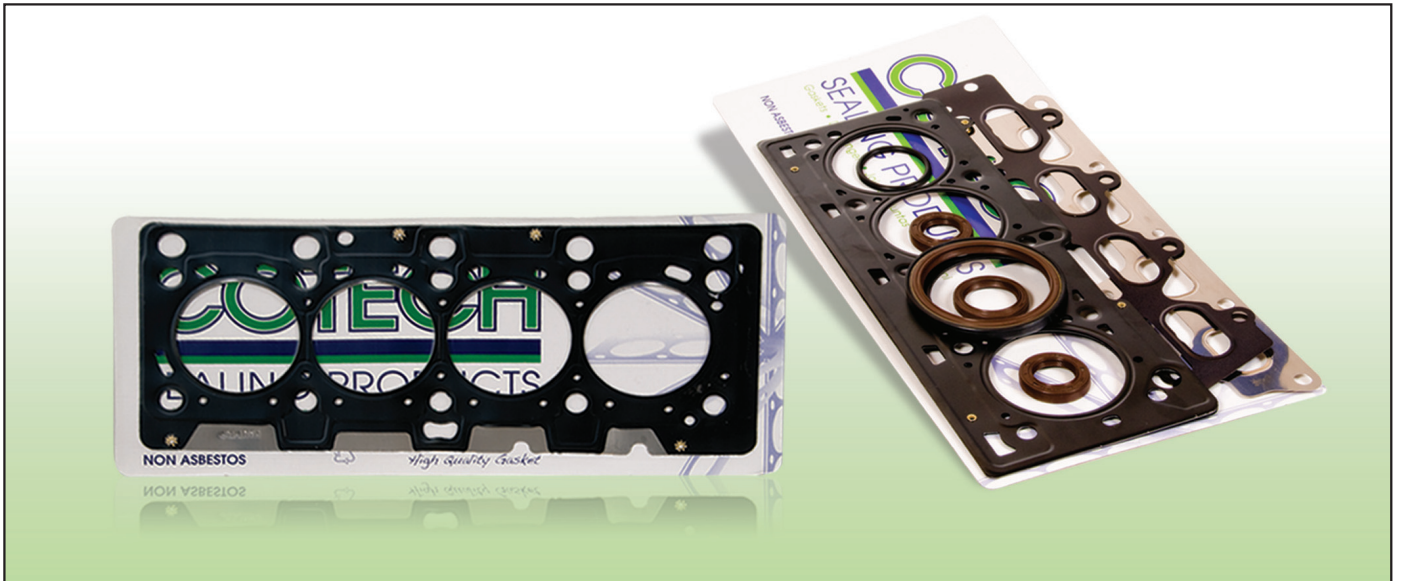





AMBALAJ / PACKAGE

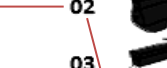

KATALOG KULLANMA BİLGİLERİ

INSTRUCTION FOR USE OF CATALOGUE

Kalınlık - Kertik - Delik
Thick - Thickness - Hole - Notch

COTECH® SEALING PRODUCTS Gaskets • Dichtungen • Joints • Juntas • Guarnizioni		PEUGEOT			00	01	02	03	04	Silindir Kapak Cylinder Head Zylinderkopf Joint de culasse
Ltr	MODEL	PS/KW	ENGINE/MOTOR							
1,9 1905	4 CYL ø83 BOXER Bus D BOXER D EXPERT D J5 Bus D J5 D PARTNER D 306 D 306 SLD 405 D	03/88--> 70 PS / 51 KW 68 PS / 50 KW	XUD9A (DJY) XUD9A (D9B) XUD9AU (D8C)		61204002 0197.H5					 61204009 0209.S5 1,36 mm 1  61204008 0209.S6 1,40 mm 2  61204007 0209.S7 1,44 mm 3  61204006 0209.S8 1,48 mm 4  61204005 0209.S9 1,53 mm 5  ø 84

▲ : İçerikte Bulunmamaktadır...

▲ : Not included in the set

▲ : Non inclus dans la pochette

00: Motor Takım Keçesiz ve Subap Lastiksiz

00: Gasket Set Without oil seals Without Valve Stem Seal

01: Motor Takım Keçesiz - Subap Lastikli

01: Gasket set With Valve Stem Seal Without Oil Seals











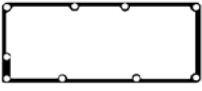





02: Motor Full Takım Keçeli ve Subap Lastikli

02: Gasket Full Set With oil seals and Valve Stem Seals

Sola Sarımlı
Left-hand twist

Sağa Sarımlı
Right-hand twist

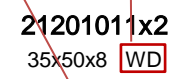
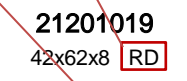
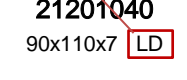
Değişken Sarımlı
Alternate twist

Subap Kapak Valve Cover Gasket Zylinderkopfhaube Couvre-culbut.	Karter Oil Pan Ölwanne Carter d'huile	Emme Manifold Intake Manifold Ansaug Admission	Egzoz Manifold Exhaust Manifold Auspuffkrümmer Collecteur D'echappement	Eksoz Boğaz Exhaust Pipe Auspuff Kehle	Supap Keçesi Valve Stem Seal Ventilschaft Queue de soupape	
						
 61203525 0249.46 0249.91	 61203013 0304.34  61203014 93501565	 61203116x2 0348.99  61203018x2 91508659	 61205019 1721.01 7810024000  61203120x2 0349.47 93010402	 60107027x8 0956.22 8x10,8/14,2x10	 21201011x2 35x50x8 WD  21201019 42x62x8 RD  21201040 90x110x7 LD	
		 61203021 0348.JO				

■ : Delik - Çentik

■ : Hole - Notch

■ : Trou - Entaille

NOT: Katalogdaki Orijinal Kodlar Referans Amacıyla Kullanılmıştır.Lütfen COTECH Kodlarını Kullanınız.
Original codes used for reference only.Please use COTECH codes for orders.

İÇİNDEKİLER / İNDEX

1- ALFA ROMEO	1 - 2
2- ASIA MOTOR	3 - 4
3- AUDI	5 - 10
4- CHEVROLET	11 - 14
5- CHRYSLER	15 - 16
6- CITROEN	17 - 32
7- DACIA	33 - 36
8- DAEWOO	37 - 42
9- DAIHATSU	43 - 44
10- FIAT	45 - 86
11- FORD	87 - 98
12- HONDA	99 - 100
13- HYUNDAI	101 - 112
14- IVECO	113 - 118
15- JOHN DEERE	119 - 138
16- KIA	139 - 150
17- LADA	151 - 156
18- LAND ROVER	157 - 158
19- MAHINDRA	159 - 160
20- MAZDA	161 - 172
21- MITSUBISHI	173 - 178
22- NISSAN	179 - 184
23- OPEL	185 - 204
24- PEUGEOT	205 - 232
25- PROTON	233 - 236
26- RENAULT	237 - 286
27- SAVIEM	287 - 288
28- SKODA	289 - 290
29- TOYOTA	281 - 294
30- VOLVO	295 - 306
31- VOLKSWAGEN	307 - 320
32- VOLGA	321 - 322
32- IKCO	323 - 324

COTECH[®]
SEALING PRODUCTS

*çevre dostu
üretim*

*green
products*



00



01



02



03



04



Silindir Kapak
Cylinder Head
Zylinderkopf
Joint de culasse

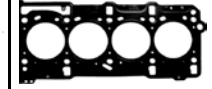

Ltr	MODEL	PS/KW	ENGINE/MOTOR		
1,8 1796	4 CYL ø80,5 159 03/07-->11/11	103 PS / 140 KW	939 A4.000		 61417005 71744395 1,20mm FIBER / FIBRE ø82
1,9 1910	4 CYL ø82 147 JTD 147 JTD 156 JTD 156 JTD 04/01--> 04/01--> 10/00-->05/01 05/01-->09/05	115 PS / 85 KW 101 PS / 74 KW 110 PS / 81 KW 115 PS / 85 KW	937 A2.000 182 B9.000 AR 37101 937 A2.000	62427802 60 816 452 62427803 71716051 62427704 71730213	 62427805 60816233 0,82mm ø83 62427806 60816234 0,92mm 1 ø83 62427807 60816235 1,02mm 2 MLS ø83
1,9 1929	4 CYL ø82,6 145 TD 146 TD 10/94-->02/99 10/94-->02/99	90 PS / 66 KW 90 PS / 66 KW	AR 33601 AR 67501		 62426605 46451596 1,90mm ø83,5
2,00 1995	4 CYL ø84 164 TURBO (DOCH) 10/87-->09/98	174 PS / 128 KW	AR 06476	62424001 60777803	 62424005 7660966 1,80mm ø85

▲ : İçerikte Bulunmamaktadır...

▲ : Not included in the set

▲ : Non inclus dans la pochette

00: Motor Takım Keçesiz ve Subap Lastiksiz

00: Gasket Set Without oil seals Without Valve Stem Seal











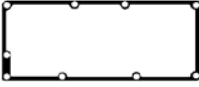





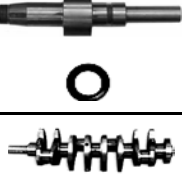

01: Motor Takım Keçesiz - Subap Lastikli

01: Gasket set With Valve Stem Seal Without Oil Seals

02: Motor Full Takım Keçeli ve Subap Lastikli

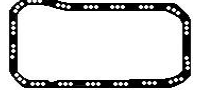
02: Gasket Full Set With oil seals and Valve Stem Seals

001

<p>Subap Kapak Valve Cover Gasket Zylinderkopfhaube Couvre-culbut.</p> 	<p>Karter Oil Pan Ölwanne Carter d'huile</p> 	<p>Emme Manifold Intake Manifold Ansaug Admission</p> 	<p>Egzoz Manifold Exhaust Manifold Auspuffkrümmer Collecteur D'echappement</p> 	<p>Eksoz Boğaz Exhaust Pipe Auspuff Kehle</p> 	<p>Supap Keçesi Valve Stem Seal Ventilschaft Queue de soupape</p> 	
 <p>62427825 46552748</p>  <p>62427826 55197598</p>		 <p>62427820 71738458</p>	 <p>62427721 46467747</p>		 <p>60107027x8 60504110 8x10,8/14,2x10</p>	<p>21208003 30x42x7 RD</p> <p>21201100 31x41x7 RD</p>
 <p>60330034x2 7660565</p>  <p>60331035x2 7684064</p>	 <p>62424013 7646248</p>	 <p>60330019 7700197</p>	 <p>60308020 4368925</p>		 <p>60107027x8 60504110 8x10,8/14,2x10</p>	

■ : Delik - Çentik

■ : Hole - Notch

■ : Trou - Entaille

NOT: Katalogdaki Orijinal Kodlar Referans Amacıyla Kullanılmıştır.Lütfen Cotech Kodlarını Kullanınız.
Original codes used for reference only.Please use COTECH codes for orders.

00



Silindir Kapak
Cylinder Head
Zylinderkopf
Joint de culasse

01



02



03



04



Ltr	MODEL	PS/KW	ENGINE/MOTOR		
1,8 1781	4 CYL ø86 ROCSTA 06/93-->12/99	77 PS / 57 KW	F804 FE		<p>61420305 F202-10-271 1,40mm 61420306 F202-10-271 1,80mm ø87,5</p>
2,2 2184	4 CYL ø86 ROCSTA 11/89 -->12/99 DIESEL 06/93-->12/99	72PS / 53KW 61PS / 45 KW	R2	61410000 8AG7-10-271	<p>61410005 R201-10-271A ø87,5</p>
2,7 2701	4 CYL ø92 HI-TOPIC 01/98-->12/99 TOPIC 06/93-->12/99 DIESEL	69 PS / 51 KW 75 PS / 55 KW		61480000 AGS-T-725M	<p>61480005 0527-10-271A ø97</p>

▲ : İçerikte Bulunmamaktadır...

▲ : Not included in the set

▲ : Non inclus dans la pochette

00: Motor Takım Keçesiz ve Subap Lastiksiz

00: Gasket Set Without oil seals Without Valve Stem Seal











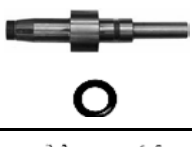
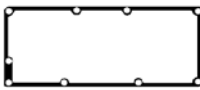



01: Motor Takım Keçesiz - Subap Lastikli

01: Gasket set With Valve Stem Seal Without Oil Seals

02: Motor Full Takım Keçeli ve Subap Lastikli

02: Gasket Full Set With oil seals and Valve Stem Seals

003

Subap Kapak Valve Cover Gasket Zylinderkopfhaube Couvre-culbut.	Karter Oil Pan Ölwanne Carter d'huile	Emme Manifold Intake Manifold Ansaug Admission	Egzoz Manifold Exhaust Manifold Auspuffkrümmer Collecteur D'echappement	Eksoz Boğaz Exhaust Pipe Auspuff Kehle	Supap Keçesi Valve Stem Seal Ventilschaft Queue de soupape	
						
						
61410025 RF01-10-235	61410013 F80110-431	61410019 RF0113-111	61410020 RF01-13-462			
						
61480025 1456-10-235	61480013 1363-89-104	61480019x4 0636-13-111	61480021x4 0750-13-461 0750-13-461A			

 : Delik - Çentik

 : Hole - Notch

 : Trou - Entaille

NOT: Katalogdaki Orijinal Kodlar Referans Amacıyla Kullanılmıştır.Lütfen COTECH Kodlarını Kullanınız.
Original codes used for reference only.Please use COTECH codes for orders.

00



01



02



03



04



Silindir Kapak
Cylinder Head
Zylinderkopf
Joint de culasse

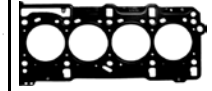

Ltr	MODEL	PS/KW	ENGINE/MOTOR		
1,4 1390	4 CYL ø76,5 A2 02/00-->08/05	75 PS / 55 KW	AUA BBY	61405303	<p>61405305 036 103 383 AL MLS ø77,5</p>
1,6 1588	4 CYL ø79,5 80 80 COUPE 08/78-->07/86 09/73-->07/86	75 PS / 55 KW 100 PS / 74 KW 75 PS / 55 KW	WW WZ XX YG YH YN	61401002 049 198 001 C 61401003 049 198 012 H 61401004 037 198 011 C	<p>61401005 049 103 383 K 1,60mm ø81</p>
1,6 1595	4 CYL ø79,5 80 80 8192242682->	110 PS / 81 KW 70 PS / 51 KW	YP YS YT YY YZ	61401002 049 198 001 C 61401003 049 198 012 H 61401004 037 198 011 C	<p>61401005 049 103 383 K 1,60mm ø81</p>
1,6 1588	4 CYL ø79,5 80 8192242683->	110 PS / 81 KW 70 PS / 51 KW	YP YS YT YY YZ	61401002 049 198 001 C 61401003 049 198 012 H 61401004 037 198 011 C	<p>61401005 049 103 383 K 1,60mm ø81</p>
1,6 1595	4 CYL ø81 80 08 /90-->10/91 09/91-->12/94 06/93-->01/96	102 PS / 75 KW 71 PS / 52 KW 101 PS / 74 KW	ABB ABM ADA DT JU RN PP RN		<p>61408005 026 103 383P 026 103 383L 026 103 383M 026 103 383N 026 103 383K 1,75mm ø83</p>

▲ : İçerikte Bulunmamaktadır...

▲ : Not included in the set

▲ : Non inclus dans la pochette

00: Motor Takım Keçesiz ve Subap Lastiksiz

00: Gasket Set Without oil seals Without Valve Stem Seal











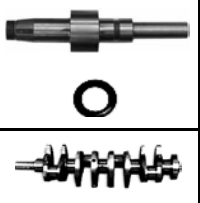
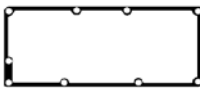











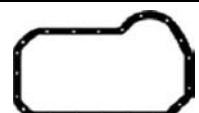

01: Motor Takım Keçesiz - Subap Lastikli

01: Gasket set With Valve Stem Seal Without Oil Seals

02: Motor Full Takım Keçeli ve Subap Lastikli

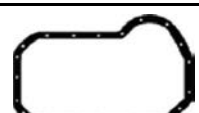
02: Gasket Full Set With oil seals and Valve Stem Seals

005

Subap Kapak Valve Cover Gasket Zylinderkopfhaube Couvre-culbut.	Karter Oil Pan Ölwanne Carter d'huile	Emme Manifold Intake Manifold Ansaug Admission	Egzoz Manifold Exhaust Manifold Auspuffkrümmer Collecteur D'echappement	Eksoz Boğaz Exhaust Pipe Auspuff Kehle	Supap Keçesi Valve Stem Seal Ventilschaft Queue de soupape	
						
62427465	62427465	61405319x4 036 129 717 E	61405321 036 253 039 F		62427426x16 036 109 675 A	21204029x2 27x42x8 RD
						21201075x3 32x47x10 W 21204504 85x105x12 LD
61401034 026 198 025 A	61401013 028 103 609 A	61401019 026 129 717 D	61401021x4 026 129 589 A 056 129 589 B	61408017 841 253 115 B	60107027x8 026 109 675 8x10,8/14,2x10	
						21201075x3 32x47x10 WD 21204504 85x105x12 LD
61401034 026 198 025 A	61401013 028 103 609 A	61401019 026 129 717 D	61401021x4 026 129 589 A 056 129 589 B	61408017 841 253 115 B	60107027x8 026 109 675 8x10,8/14,2x10	
						21201075x3 32x47x10 WD 21204504 85x105x12 LD
61401034 026 198 025 A	61401013 028 103 609 A	1401019 026 129 717 D	61401021x4 026 129 589 A 056 129 589 B	61408017 841 253 115 B	60107027x8 026 109 675 8x10,8/14,2x10	

■ : Delik - Çentik

■ : Hole - Notch

■ : Trou - Entaille

NOT: Katalogdaki Orijinal Kodlar Referans Amacıyla Kullanılmıştır. Lütfen COTECH Kodlarını Kullanınız.
Original codes used for reference only. Please use COTECH codes for orders.

AUDI

00



01



02



03



04



Silindir Kapak
Cylinder Head
Zylinderkopf
Joint de culasse



Ltr	MODEL	PS/KW	ENGINE/MOTOR			
1,6 1588	4 CYL ø76,5					
	DIESEL					
	80	08/80-->08/91	55 PS / 40 KW	JK	61402002 Motor Full Takım Gasket Full Set 	 61402005 068 103 383 FN 1,60mm 3 ■
	TURBO DIESEL					
	80 TD	08/81-->08/91	70 PS / 51 KW	CY	61402003 068 198 012 L 068 198 012 E 033 198 012 A 	61402006 068 103 383 FM 1,50mm 2 ■
	80 TD	08/85->09/91		RA SB	61402004 037 198 011 C 	61402007 068 103 383 FL 1,40mm 1 ■ ø78,5
						 61403005 068 103 383 EK 1,61mm 3 ■
						61403006 068 103 383 EJ 1,57mm 2 ■
						61403007 068 103 383 EH 1,53mm 1 ■ ø78,5
						 61408005 026 103 383 P 026 103 383 L 026 103 383 M 026 103 383 N 026 103 383 K 1,75mm ø83
1,8 1781	4 CYL ø81			DD		
	AUDI COUPE	08/81-->11/90	90 PS / 66 KW	DR		
	100	08/82-->10/91	75 PS / 55KW	DS		
	80	08/84-->10/91	112 PS / 82 KW	JV		
		09/86-->08/90	110 PS / 81 KW	JW		
			113 PS / 83 KW	NP		
				SH		
				4B		
				DZ		
				JN		
			PH			
			PM			
			PV			
			RS			
			MU			
			NE			
			SF			
			SD			

▲ : İçerikte Bulunmamaktadır...

▲ : Not included in the set

▲ : Non inclus dans la pochette

00: Motor Takım Keçesiz ve Subap Lastiksiz











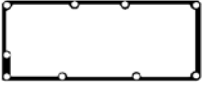
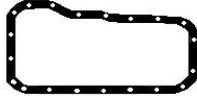

00: Gasket Set Without oil seals Without Valve Stem Seal

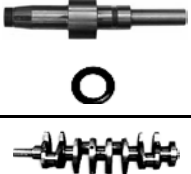
01: Motor Takım Keçesiz - Subap Lastikli

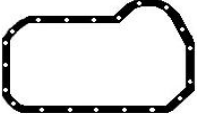
01: Gasket set With Valve Stem Seal Without Oil Seals

02: Motor Full Takım Keçeli ve Subap Lastikli

02: Gasket Full Set With oil seals and Valve Stem Seals

<p>Subap Kapak Valve Cover Gasket Zylinderkopfhaube Couvre-culbut.</p> 	<p>Karter Oil Pan Ölwanne Carter d'huile</p> 	<p>Emme Manifold Intake Manifold Ansaug Admission</p> 	<p>Egzoz Manifold Exhaust Manifold Auspuffkrümmer Collecteur D'echappement</p> 	<p>Eksoz Boğaz Exhaust Pipe Auspuff Kehle</p> 	<p>Supap Keçesi Valve Stem Seal Ventilschaft Queue de soupape</p> 	
 <p>61401034 026 103 483 026 103 483 B 026 103 483 C 056 103 483 D</p>	 <p>61401013 028 103 609 A 034 129 717 C</p>	 <p>61401019 026 129 717D</p>  <p>61402019 068 129 717 E</p>	 <p>61401021x4 026 129 589 A 028 129 589 B</p>	 <p>61401017 841 253 115 B</p>	 <p>60107027x8 7553637 8x10,8/14,2x10</p>	<p>21201075x3 32x47x10 WD</p> <p>21204504 85x105x12 LD</p>

■ : Delik - Çentik

■ : Hole - Notch

■ : Trou - Entaille

NOT: Katalogdaki Orijinal Kodlar Referans Amacıyla Kullanılmıştır.Lütfen COTECH Kodlarını Kullanınız.
Original codes used for reference only.Please use COTECH codes for orders.

AUDI

00



01



02



03



04



Silindir Kapak
Cylinder Head
Zylinderkopf
Joint de culasse

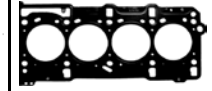

Ltr	MODEL	PS/KW	ENGINE/MOTOR		
1,9 1896	4 CYL ø79,5 80 D 08/89-->08/91 80 TD 08/91-->12/94	68 PS / 50 KW 75 PS / 55 KW	1Y AAZ	61405103 028 198 012 B	 61405105 028 103 383 BD 1,70mm 3 ■ 61405106 028 103 383 BC 1,65mm 2 ■ 61405107 028 103 383 BB 1,60mm 1 ■ ø81
1,9 1896	4 CYL ø79,5 AUDI A80 TDI 09/91-->01/96 A4 TDI 01/95-->09/01 A6 TDI 06/94-->12/97 CABRIO TDI 06/95-->08/00	90 PS / 66 KW 110 PS / 81 KW 75 PS / 55 KW	1Z AHH AHU AFN AVG AFF	61405203 028 198 012 C	 61405205 028 103 383 BR 028 103 383 BN 1,61mm 3 ■ 61405206 028 103 383 BQ 028 103 383 BM 1,53mm 2 ■ 61405207 028 103 383 BP 028 103 383 BL 1,45mm 1 ■ MLS ø81
2,0 1984	4 CYL ø82,5mm AUDI COUPE 05/89-->12/96 100 12/90-->06/94 80 01/93-->09/98 CABRIOLET 01/91--> 07/95 16 VALVE	112 PS / 82 KW 100 PS / 74 KW 115 PS / 82 KW 115 PS / 85 KW	AAD AAE ABK ABT ADW SD 3A		 61408105 048 103 383 B 1,75mm ø83,5

▲ : İçerikte Bulunmamaktadır...

▲ : Not included in the set

▲ : Non inclus dans la pochette

00: Motor Takım Keçesiz ve Subap Lastiksiz











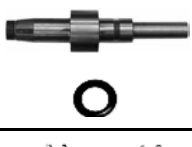
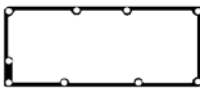





00: Gasket Set Without oil seals Without Valve Stem Seal

01: Motor Takım Keçesiz - Subap Lastikli

01: Gasket set With Valve Stem Seal Without Oil Seals

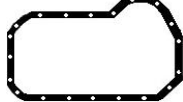
02: Motor Full Takım Keçeli ve Subap Lastikli

02: Gasket Full Set With oil seals and Valve Stem Seals

Subap Kapak Valve Cover Gasket Zylinderkopfhaube Couvre-culbut.	Karter Oil Pan Ölwanne Carter d'huile	Emme Manifold Intake Manifold Ansaug Admission	Egzoz Manifold Exhaust Manifold Auspuffkrümmer Collecteur D'echappement	Eksoz Boğaz Exhaust Pipe Auspuff Kehle	Supap Keçesi Valve Stem Seal Ventilschaft Queue de soupape	
						
						21208042 32x47x10 WD
61405125 028 103 483 F 028 103 483 H		61405121 028 129 717 D	61401021x4 026 129 589 A 028 129 589 B		60107027x8 7553637 8x10,8/14,2x10	21204504 85x105x12 LD
						21208042x2 32x47x10 WD
						21208042 32x47x10 WD
61405225 028 103 483 C 028 103 483 G	61401014 044 103 609 D	61405121 028 129 717 D	61401021x4 026 129 589 A 028 129 589 B		60107027x8 7553637 8x10,8/14,2x10	21204504 85x105x12 LD
						21208042x2 32x47x10 WD

 : Delik - Çentik

 : Hole - Notch

 : Trou - Entaille

NOT: Katalogdaki Orijinal Kodlar Referans Amacıyla Kullanılmıştır.Lütfen COTECH Kodlarını Kullanınız.
Original codes used for reference only.Please use COTECH codes for orders.

00



01



02



03



04



Silindir Kapak
Cylinder Head
Zylinderkopf
Joint de culasse

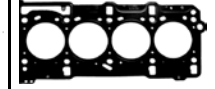

Ltr	MODEL	PS/KW	ENGINE/MOTOR	
0,8 796	3 CYL ø68,5 MATIZ SPARK 03/05-->	52 PS / 38 KW 50 PS / 30 KW	F8CV	
				<p>61460105 11141A78B01-00 2,00mm ø69,5</p>
1,4 1393	4 CYL ø82 CHEVETTE 1976-->1977	85 PS / 45 KW	85	
				<p>61415205 1,20mm ø83</p>
1,4 1393	4 CYL ø77,9 AVEO (SOHC)	83 PS / 61KW	F14S3	
				<p>62447305 5607408 1,40mm ø80,5</p>
1,4 1399	4 CYL ø77,9 AVEO LACETTI NUBIRA OPTRA KALOS (DOCH 16 V)	94 PS / 69 KW	F14D3	
				<p>62450105 96473400 1,20mm FIBER / FIBRE ø80</p>
1,6 1598	4 CYL ø79 AVEO KALOS NUBIRA OPTRA LACETTI CRUZE (DOCH16V)	109 PS / 80 KW	F16D3 F16D4 A16DMS	
				<p>62450205 96378802 1,20mm FIBER / FIBRE ø80</p>
1,6 1599	4 CYL ø82 CHEVETTE 1976-->1987	85 PS / 45 KW	98	
				<p>61415205 1,20mm ø83</p>

▲ : İçerikte Bulunmamaktadır...

▲ : Not included in the set

▲ : Non inclus dans la pochette

00: Motor Takım Keçesiz ve Subap Lastiksiz







00: Gasket Set Without oil seals Without Valve Stem Seal

01: Motor Takım Keçesiz - Subap Lastikli

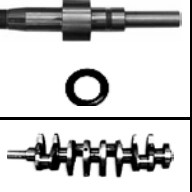
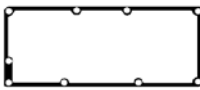
01: Gasket set With Valve Stem Seal Without Oil Seals

02: Motor Full Takım Keçeli ve Subap Lastikli

02: Gasket Full Set With oil seals and Valve Stem Seals

Subap Kapak Valve Cover Gasket Zylinderkopfhaube Couvre-culbut.	Karter Oil Pan Ölwanne Carter d'huile	Emme Manifold Intake Manifold Ansaug Admission	Egzoz Manifold Exhaust Manifold Auspuffkrümmer Collecteur D'echappement	Eksoz Boğaz Exhaust Pipe Auspuff Kehle	Supap Keçesi Valve Stem Seal Ventilschaft Queue de soupape	
						

 : Delik - Çentik

 : Hole - Notch

 : Trou - Entaille

NOT: Katalogdaki Orijinal Kodlar Referans Amacıyla Kullanılmıştır.Lütfen COTECH Kodlarını Kullanınız.
Original codes used for reference only.Please use COTECH codes for orders.

00



Silindir Kapak

Cylinder Head

01



Zylinderkopf

02



Joint de culasse

03



04

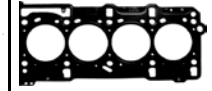

Ltr	MODEL	PS/KW	ENGINE/MOTOR	
1,6 1598	4 CYL ø77,9 AVEO LACETTI NUBIRA OPTRA KALOS (DOCH 16 V)	03/05-->01/09 94 PS / 69 KW	F16D3	 62450105 96473400 1,20mm FIBER / FIBRE ø80
2,0 1998	4 CYL ø86 VIVANT EPICA REZZO TACUMA EVANDA (DOCH 16 V)	2000-->2007 2003 01/05-->12/06 09/2000 08/02-->2006 122 PS / 89 KW 131 PS / 96 KW	T20SED X20SED	 62447605 5607449 1,40mm ø87,5

▲ : İçerikte Bulunmamaktadır...

▲ : Not included in the set

▲ : Non inclus dans la pochette

00: Motor Takım Keçesiz ve Subap Lastiksiz







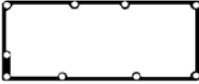

00: Gasket Set Without oil seals Without Valve Stem Seal

01: Motor Takım Keçesiz - Subap Lastikli

01: Gasket set With Valve Stem Seal Without Oil Seals

02: Motor Full Takım Keçeli ve Subap Lastikli

02: Gasket Full Set With oil seals and Valve Stem Seals

<p>Subap Kapak Valve Cover Gasket Zylinderkopfhaube Couvre-culbut.</p> 	<p>Karter Oil Pan Ölwanne Carter d'huile</p> 	<p>Emme Manifold Intake Manifold Ansaug Admission</p> 	<p>Egzoz Manifold Exhaust Manifold Auspuffkrümmer Collecteur D'echappement</p> 	<p>Eksoz Boğaz Exhaust Pipe Auspuff Kehle</p> 	<p>Supap Keçesi Valve Stem Seal Ventilschaft Queue de soupape</p> 	  

■ : Delik - Çentik

■ : Hole - Notch

■ : Trou - Entaille

NOT: Katalogdaki Orijinal Kodlar Referans Amacıyla Kullanılmıştır.Lütfen COTECH Kodlarını Kullanınız.
Original codes used for reference only.Please use COTECH codes for orders.

00



01



02



03



04



Silindir Kapak
Cylinder Head
Zylinderkopf
Joint de culasse

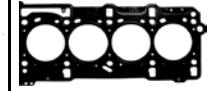

Ltr	MODEL	PS/KW	ENGINE/MOTOR		
1,5 1468	4 CYL ø75,5 COLT PREMIER (SOCH)	84 PS / 63 KW	G15B		<p>61500305 MD016163 1,40mm</p> <p>61500306 MD016163 2,00mm ø76,5</p>
1,5 1468	4 CYL ø75,5 COLT 12V (SOCH)	90 PS / 66 KW	4G15		<p>61415405 MD323473 1,40mm ø76,5</p>
2,3 2346	4 CYL ø91 PICK-UP RAM 50 TD PICK-UP POWER RAM 50 TD (SOCH) 1983-->1985	68 PS / 50 KW	4D55T	<p>61450001 MD050092</p> <p>61450002 MD050092</p>	<p>61450005 MD050545 1,80mm</p> <p>ø92,5</p>

▲ : İçerikte Bulunmamaktadır...

▲ : Not included in the set

▲ : Non inclus dans la pochette

00: Motor Takım Keçesiz ve Subap Lastiksiz









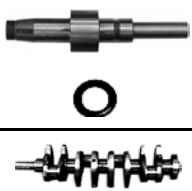
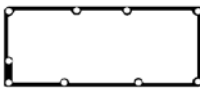

00: Gasket Set Without oil seals Without Valve Stem Seal

01: Motor Takım Keçesiz - Subap Lastikli

01: Gasket set With Valve Stem Seal Without Oil Seals

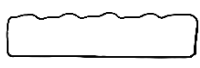
02: Motor Full Takım Keçeli ve Subap Lastikli

02: Gasket Full Set With oil seals and Valve Stem Seals

Subap Kapak Valve Cover Gasket Zylinderkopfhaube Couvre-culbut.	Karter Oil Pan Ölwanne Carter d'huile	Emme Manifold Intake Manifold Ansaug Admission	Egzoz Manifold Exhaust Manifold Auspuffkrümmer Collecteur D'echappement	Eksoz Boğaz Exhaust Pipe Auspuff Kehle	Supap Keçesi Valve Stem Seal Ventilschaft Queue de soupape	
						
						21201013 35x50x8 RD
61450025 MD050312	61450013 MD149392	61450021 MD050482			61450026x8 8x13x9x13	21201023 44x60x7 RD
						21201035 80x96x9 LD
						21201004 25x35x6
						21201001 17x28x7

 : Delik - Çentik

 : Hole - Notch

 : Trou - Entaille

NOT: Katalogdaki Orijinal Kodlar Referans Amacıyla Kullanılmıştır.Lütfen COTECH Kodlarını Kullanınız.
Original codes used for reference only.Please use COTECH codes for orders.

00



01



02



03



04



Silindir Kapak
Cylinder Head
Zylinderkopf
Joint de culasse

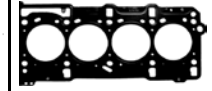

Ltr	MODEL	PS/KW	ENGINE/MOTOR		
1,0 954	4 CYL ø70 LNA 10 07/84->10 /86 VISA 10 C 15	45 PS / 33 KW	108C	61216002 198,57	 61216005 0203.84 1,20mm Loc ø16mm 61216006 0203.22 1,40mm ø74
1,0 954	4 CYL ø70 AX10 07/86-->12/98 AX10 07/92->12/98 AX10 07/92->12/98 C15E 10/84->12/97 SAXO 05/98-> SAXO 1996-> SAXO 05/1996->	45PS / 33KW 50PS / 37KW 50PS / 37KW 45PS / 33KW 45PS / 33KW 45PS / 33KW 45PS / 33KW	C1A (TU9) CDZ (TU9M) CDY (TU9M) C1A (TU9) CDY (TU9L) C1A (TU9M) CDZ (TU9L)	61221002 Motor Full Takım Gasket Full Set 61221003 0197.H8+0209.89 61209004 0197.H9	 61221005 0209.89 1,30mm 1 61221006 0209.90 1,50mm 2 ø73,5
1,1 1124	4 CYL ø72 BERLINGO 07/96-> SAXO 05/96-> ZX 07/96->08/97 INJECTION	60PS / 44KW 60PS / 44KW 60PS / 44KW	HDY (TU1M+) HDZ(TU1M+) TU1M+	61221002 Motor Full Takım Gasket Full Set 61221003 0197.H8+0209.89 61209004 0197.H9	 61221005 0209.89 1,30mm 1 61221006 0209.90 1,50mm 2 ø73,5
1,1 1124	4 CYL ø72 AX 11 1986->1997 AX 11 4x4 06/94->07/92 BX 11 10/86->06/92 C15 E 07/88->12/96 ZX 07/91->06/95	55PS / 40KW 55PS / 40KW 55PS / 40KW 55PS / 40KW 55PS / 40KW	H1B (TU1CLC) HDZ (TU1M) H1A (TU1) H1A (TU1) H1A (TU1) TU1MZ	61209002 Motor Full Takım Gasket Full Set 61209003 0197.H8+0209.CJ 61209004 0197.H9	 61209005 0209.CJ 1,30mm 1 61209006 0209.W6 - W7 1,50 mm 2 ø76

▲ : İçerikte Bulunmamaktadır...

▲ : Not included in the set

▲ : Non inclus dans la pochette

00: Motor Takım Keçesiz ve Subap Lastiksiz











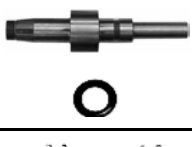
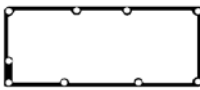













00: Gasket Set Without oil seals Without Valve Stem Seal

01: Motor Takım Keçesiz - Subap Lastikli

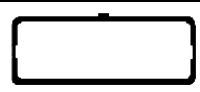
01: Gasket set With Valve Stem Seal Without Oil Seals

02: Motor Full Takım Keçeli ve Subap Lastikli

02: Gasket Full Set With oil seals and Valve Stem Seals

Subap Kapak Valve Cover Gasket Zylinderkopfhaube Couvre-culbut.	Karter Oil Pan Ölwanne Carter d'huile	Emme Manifold Intake Manifold Ansaug Admission	Egzoz Manifold Exhaust Manifold Auspuffkrümmer Collecteur D'echappement	Eksoz Boğaz Exhaust Pipe Auspuff Kehle	Supap Keçesi Valve Stem Seal Ventilschaft Queue de soupape	
						
61201525 0249.39	61201013 0304.46	61201018 0384.54	61201020 0349.16	61205017 7700657683	60107027x8 956,22 8x10.8/14.2x10	21201013 35x50x8 WD 21201033 78x100x10 LD
						21201062 36x50x7 RD
61209025 0249.54	61209013 0304.304	61209019x2	61209020x2 0349,A6	61209017 1709.15	60116026x8 0956.19 7x9,8/13.2x10	21201021 42x66x6 RD 21204504 85x105x8 LD
						21201062 36x50x7 RD
61209025 0249.54	61209013 0304.304	61209019x2	61209020x2 0349,A6	61209017 1709.15	60116026x8 0956.19 7x9,8/13.2x10	21201021 42x66x6 RD 21204504 85x105x8 LD
						21201062 36x50x7 RD
61209025 0249.54	61209013 0304.304	61209019x2	61209020x2 0349,A6	61209017 1709.15	60116026x8 0956.19 7x9,8/13.2x10	21201021 42x66x6 RD 21204504 85x105x8 LD

■ : Delik - Çentik

■ : Hole - Notch

■ : Trou - Entaille

NOT: Katalogdaki Orijinal Kodlar Referans Amacıyla Kullanılmıştır.Lütfen COTECH Kodlarını Kullanınız.
Original codes used for reference only.Please use COTECH codes for orders.

00



Silindir Kapak
Cylinder Head
Zylinderkopf
Joint de culasse

01



02



03



04

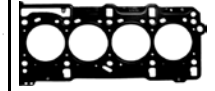

Ltr	MODEL	PS/KW	ENGINE/MOTOR		
1,1 1124	4 CYL ø72 BERLINGO 07/96--> C2 09/03--> C3 02/02--> SAXO 05/96-->	60PS / 44 KW	HFX (TU1JP)		 61222005 0209.Y0 1,30mm 1 61222006 0209.Y1 1,50mm 2 ø74
1,1 1118	4 CYL ø74 C15 E 10/84->10/96	48PS / 35KW	E1A (E1)		 61208005 0209.H9 1,20mm ø77
1,3 1294	4 CYL ø75 AX 13 SPORT 04/87-->12/88	95PS / 70KW	M4A	61209002 Motor Full Takım Gasket Full Set 61209003 0197.H8+0209.CJ 61209004 0197.H9	 61209005 0209.CJ 1,30mm 1 61209006 0209.W6 - W7 1,50 mm 2 ø76
1,4 1360	4 CYL ø75 VISA GT 07/82-->04/85 BX 14 04/83-->02/93 C15 VISA	72PS / 53KW 67PS / 49 KW 75PS / 55 KW	150A 150B 150C 150D 150F	61201002 0197.77	 61201005 0209.A6 1,30mm Loc 14mm ø76
1,4 1360	4 CYL ø75 C2 06/06--> C3 12/03--> C4 11/04--> 16 V	88PS / 65KW	KFU (ET3J4)		 62190005 0209.CH 0209.FL 1,40mm ø76

▲ : İçerikte Bulunmamaktadır...

▲ : Not included in the set

▲ : Non inclus dans la pochette

00: Motor Takım Keçesiz ve Subap Lastiksiz











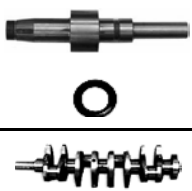
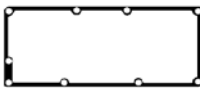







00: Gasket Set Without oil seals Without Valve Stem Seal

01: Motor Takım Keçesiz - Subap Lastikli

01: Gasket set With Valve Stem Seal Without Oil Seals

02: Motor Full Takım Keçeli ve Subap Lastikli

02: Gasket Full Set With oil seals and Valve Stem Seals

Subap Kapak Valve Cover Gasket Zylinderkopfhaube Couvre-culbut.	Karter Oil Pan Ölwanne Carter d'huile	Emme Manifold Intake Manifold Ansaug Admission	Egzoz Manifold Exhaust Manifold Auspuffkrümmer Collecteur D'echappement	Eksoz Boğaz Exhaust Pipe Auspuff Kehle	Supap Keçesi Valve Stem Seal Ventilschaft Queue de soupape	
						
						21201062 36x50x7 RD
61209025 0249.54	61209013 0304.304	61209019x2	61209020x2 0349,A6	61209017 1709.15	60116026x8 0956.19 7x9,8/13.2x10	21201021 42x66x6 RD
						21204504 85x105x8 LD
						21201013 35x50x8 WD
61201525 0249.39	61201013 0304.46	61201018 0384.54	61201020 0349.16	61205017 7700657683	60107027x8 956,22 8x10.8/14.2x10	21201033 78x100x10 LD

■ : Delik - Çentik

■ : Hole - Notch

■ : Trou - Entaille

NOT: Katalogdaki Orijinal Kodlar Referans Amacıyla Kullanılmıştır.Lütfen COTECH Kodlarını Kullanınız.
Original codes used for reference only.Please use COTECH codes for orders.

00



01



02



03









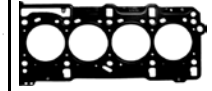

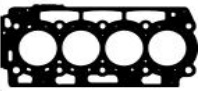

04



Silindir Kapak
Cylinder Head
Zylinderkopf
Joint de culasse



Ltr	MODEL	PS/KW	ENGINE/MOTOR		
1,4 1398	4 CYL ø74 C1 HDI 06/05--> C2 HDI 09/03--> C3 HDI 02/02--> C3 Pluriel HDI 04/04--> XSARA HDI 01/03-->08/05 Nemo HDI 02/08-->	68PS / 50KW 54PS / 40KW	DV4D DV4TD 8HX(DV4TD)	61706002 Motor Full Takım Gasket Full Set  61706003 Motor Üst Takım Gasket Head Set  61706004 Motor Alt Takım Conversion Set	 61706005 0209.AH 1,45mm 5  61706006 0209.AG 1,40mm 4  61706007 0209.AE 1,30mm 3  61706008 0209.AC 1,25mm 2  61706009 0209.AF 1,35mm 1  MLS ø75
1,4 1360	4 CYL ø75 BERLINGO 03/91--> SAXO VTS XSARA ZX C2 02/02--> C3 C3 Pluriel AX 04/83-->10/97 AX 14 BX 14 C15 ZX	75PS / 55KW 73PS / 53KW 85PS / 62 KW 54PS / 40 KW	KFW (TU3JP) KFX (TU3JP) TU3JP KFV (TU3JP) KAY (TU3CP) KAZ KDX (TU3M/Z) KDY (TU3FM) KDY (TU3M) K1B K1F K1G K1H (TU3A) K2A K2B K2D K3A	61209002 Motor Full Takım Gasket Full Set 61209003 0197.H8+0209.CJ 61209004 0197.H9	 61209005 0209.CJ 1,30mm 1  61209006 0209.W6 - W7 1,50 mm 2  ø76

▲ : İçerikte Bulunmamaktadır...

▲ : Not included in the set

▲ : Non inclus dans la pochette

00: Motor Takım Keçesiz ve Subap Lastiksiz











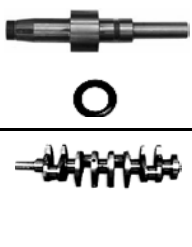
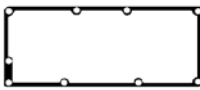



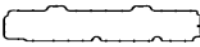

00: Gasket Set Without oil seals Without Valve Stem Seal

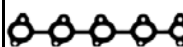
01: Motor Takım Keçesiz - Subap Lastikli

01: Gasket set With Valve Stem Seal Without Oil Seals

02: Motor Full Takım Keçeli ve Subap Lastikli

02: Gasket Full Set With oil seals and Valve Stem Seals

Subap Kapak Valve Cover Gasket Zylinderkopfhaube Couvre-culbut.	Karter Oil Pan Ölwanne Carter d'huile	Emme Manifold Intake Manifold Ansaug Admission	Egzoz Manifold Exhaust Manifold Auspuffkrümmer Collecteur D'echappement	Eksoz Boğaz Exhaust Pipe Auspuff Kehle	Supap Keçesi Valve Stem Seal Ventilschaft Queue de soupape	
						
						21204017 27x47x7 RD
61706025 0249.C1 0249.F8 1 148 101	62427465	61706019x4 0348.R2 0348.T8	61706021 0349.J8 0349.J7		61706027x8 0956.50 5,5x9,5x22,9x17,5	21204018 40x55x6,4 LD
						21204019 85x105x8,8 RD
						21201062 36x50x7 RD
61209025 0249.54	61209013 0304.304	61209019x2	61209020x2 0349,A6	61209017 1709.15	60116026x8 0956.19 7x9,8/13.2x10	21201021 42x66x6 RD
						21204504 85x105x8 LD

 : Delik - Çentik

 : Hole - Notch

 : Trou - Entaille

NOT: Katalogdaki Orijinal Kodlar Referans Amacıyla Kullanılmıştır.Lütfen COTECH Kodlarını Kullanınız.
Original codes used for reference only.Please use COTECH codes for orders.

00



01



02



03



04



Silindir Kapak
Cylinder Head
Zylinderkopf
Joint de culasse

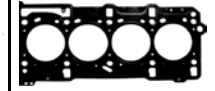

Ltr	MODEL	PS/KW	ENGINE/MOTOR		
1,4 1360	4 CYL ø75 AX AX 14 BX14 C 15 ZX 09/1986-->06/1997	85PS / 62 KW 55PS / 40KW	KDZ (TU3M/Z) KAY (TU3CP) K1B K1F K1G K1H (TU3A) K2A K2B K3A	61209002 Motor Full Takım Gasket Full Set 61209003 0197.H8+0209.CJ 61209004 0197.H9	61209005 0209.CJ 1,30mm 1 61209006 0209.W6 - W7 1,50 mm 2 ø76
1,6 1560	4 CYL ø75 BERLINGO HDI BERLINGO HDI 75 BERLINGO HDI 90 C2 HDI C3 HDI C3 HDI 16V C4 C4 HDI C4 HDI 110 FAP C4 HDI 90 C5 HDI XSARA PICASSO HDI 05/04--> 11/04-->	109PS / 80 KW 90PS / 66 KW	DV6ATED4 DV6B DV6TED4 9HT (DV6BTED4) 9HT (DV6BUTED4) 9HX (DV6ATED4) 9HY (DV6TED4) 9HZ (DV6TED4)	61707002 Motor Full Takım Gasket Full Set 61707003 Motor Üst Takım Gasket Head Set 61707004 Motor Alt Takım Conversion Set	61707005 0209.CG 1,45mm 5 61707006 0209.CF 1,40mm 4 61707007 0209.CC 1,30mm 3 61707008 0209.CA 1,25mm 2 61707009 0209.CE 1,35mm 1 MLS ø76
1,6 1587	4 CYL ø78,5 BERLINGO BERLINGO 16V C2 C3 Pluriel C3 16V C4 C4 16V XSARA PICASSO 16V XSARA 16V C2 VTS 09/00--> 01/05-->	110PS / 81KW 90PS / 66 KW 122PS / 90 KW	NFR (TU5JP4B) NFU (TU5JP4) NFS (TU5JP4S)	62200002 0135.EH 62200003 Motor Üst Takım Gasket Head Set 62200004 Motor Alt Takım Conversion Set	62200005 0209.1E MLS ø79,5

▲ : İçerikte Bulunmamaktadır...

▲ : Not included in the set

▲ : Non inclus dans la pochette

00: Motor Takım Keçesiz ve Subap Lastiksiz











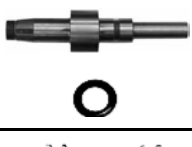
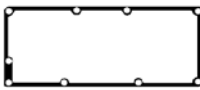





00: Gasket Set Without oil seals Without Valve Stem Seal

01: Motor Takım Keçesiz - Subap Lastikli

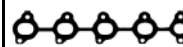
01: Gasket set With Valve Stem Seal Without Oil Seals

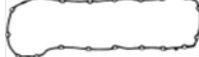
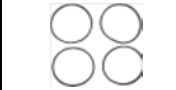
02: Motor Full Takım Keçeli ve Subap Lastikli

02: Gasket Full Set With oil seals and Valve Stem Seals

Subap Kapak Valve Cover Gasket Zylinderkopfhaube Couvre-culbut.	Karter Oil Pan Ölwanne Carter d'huile	Emme Manifold Intake Manifold Ansaug Admission	Egzoz Manifold Exhaust Manifold Auspuffkrümmer Collecteur D'echappement	Eksoz Boğaz Exhaust Pipe Auspuff Kehle	Supap Keçesi Valve Stem Seal Ventilschaft Queue de soupape	
						
61209025 0249.54	61209013 0304.304	61209019x2	61209020x2 0349,A6	61209017 1709.15	60116026x8 0956.19 7x9,8/13.2x10	21201062 36x50x7 RD
						21201021 42x66x6 RD
						21204504 85x105x8 LD
						21204017 27x47x7 RD
61707025 0249.C2	62427465	0348.R5 x4	61706021 0349.J8 0349.J7 0349.N0 1 148 115		61707026x16 0956.51 5,5x9,5x18,1x14	21204018 40x55x6,4 LD
		0348.R4 x4				21204019 85x105x8,8 RD
		61707018 0348.R5+0348.R4				
						21201741x2 38x50x6 RD
62200025 0249.A9	62200065 0304.55	62200018x4 0348.Q5	62200021 0349.J4	62200017 1709.25	62427426x16 0956.40 6x8,8x11,7x9,5	21201021 42x66x6 RD
						21204504 85x105x8 LD

■ : Delik - Çentik

■ : Hole - Notch

■ : Trou - Entaille

NOT: Katalogdaki Orijinal Kodlar Referans Amacıyla Kullanılmıştır.Lütfen COTECH Kodlarını Kullanınız.
Original codes used for reference only.Please use COTECH codes for orders.

00



01



02



03



04



Silindir Kapak
Cylinder Head
Zylinderkopf
Joint de culasse

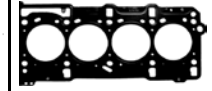

Ltr	MODEL	PS/KW	ENGINE/MOTOR		
1,6 1580	4 CYL ø83 BX 10/82-->12/94 BX16 01/87-->10/97 ZX VISA 16 GTI	88 PS / 65 KW 72 PS / 53 KW 116 PS / 85 KW 87 PS / 64 KW	BAY (XU5CP) BAZ (XU5CP) BDY (XU5M) BDZ (XU5M) B1A (XU51C/K) B1E (XU51C) B6D XU52C 171A 171B 171C 171D 180Z	61207002 0197.89+0209.E1 61207003 0197.H6+0209.E1 62130002 0197.89+0209.L3 62130003 0197.H6+0209.L3	 61207005 0209.E1 1,30mm 1 61207006 0209.L8 1,50mm 2 62130005 0209.L3 1,50mm ø84,5
1,6 1580	4 CYL ø83 XANTIA 03/91-->01/98 ZX	88 PS / 65 KW	BFZ (XU5JP)	61233002 0197.G4+0209.E1	 61207005 0209.E1 1,30mm 1 61207006 0209.L8 1,50mm 2 ø84,5
1,8 1769	4 CYL ø80 BERLINGO D 04/84--> BX 18 D C15 D VISA 17 D XSARA D ZX D	60 PS / 44 KW 58 PS / 43 KW	A9A (XUD7) 161 (XUD7) 161A (XUD7)	61204002 0197.H5 61204003 0197.H4 	 61203009 0209.S0 1,36 mm. 1 61203008 0209.S1 1,40 mm. 2 61203007 0209.S2 1,44 mm. 3 61203006 0209.S3 1,48 mm. 4 61203005 0209.S4 1,53 mm. 5 ø82

▲ : İçerikte Bulunmamaktadır...

▲ : Not included in the set

▲ : Non inclus dans la pochette

00: Motor Takım Keçesiz ve Subap Lastiksiz











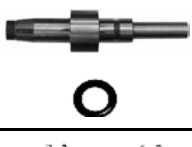
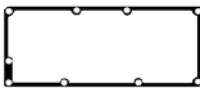

















00: Gasket Set Without oil seals Without Valve Stem Seal

01: Motor Takım Keçesiz - Subap Lastikli

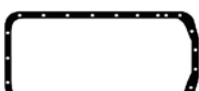
01: Gasket set With Valve Stem Seal Without Oil Seals

02: Motor Full Takım Keçeli ve Subap Lastikli

02: Gasket Full Set With oil seals and Valve Stem Seals

Subap Kapak Valve Cover Gasket Zylinderkopfhaube Couvre-culbut.	Karter Oil Pan Ölwanne Carter d'huile	Emme Manifold Intake Manifold Ansaug Admission	Egzoz Manifold Exhaust Manifold Auspuffkrümmer Collecteur D'échappement	Eksoz Boğaz Exhaust Pipe Auspuff Kehle	Supap Keçesi Valve Stem Seal Ventilschaft Queue de soupape	
						
 61207525 0249.48 91508054	 61203013 0304.34 93502226  61203014 93501565	 61203018x2 91508659. BX->1984  61207018 951299280  61207019 0348.76	 61207020x4 0349.70 91505500  61205019 1721.01 7810024000	 61207017 1710.39 91511460	 60107027x8 0956.22 8x10,8/14,2x10	21201062 36x50x7 RD 21201019 42x62x8 RD 21201040 90x110x10 LD
 61233025 0249.71	 61203013 0304.34 93502226.	 61233018x4 0348.E6 + 0348F6	 61233020x4 1723.63		 60107027x8 0956.22 8x10,8/14,2x10	21201062 36x50x7 RD 21201019 42x62x8 RD 21201040 90x110x10 LD
 61203525 0249.46 0249.91 93501444	 61203013 0304.34 93502226.  61203014 93501565	 61203020x2 9456044080  61203018 9456043980	 61205019 1721.01 7810024000  61203120x2 0349.78		 60107027x8 0956.22 8x10,8/14,2x10	21201062 36x50x7 RD 21201019 42x62x8 RD 21201040 90x110x10 LD

■ : Delik - Çentik

■ : Hole - Notch

■ : Trou - Entaille

NOT: Katalogdaki Orijinal Kodlar Referans Amacıyla Kullanılmıştır.Lütfen COTECH Kodlarını Kullanınız.
Original codes used for reference only.Please use COTECH codes for orders.

00



01



02



03



04



Silindir Kapak
Cylinder Head
Zylinderkopf
Joint de culasse

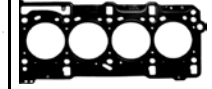

Ltr	MODEL	PS/KW	ENGINE/MOTOR		
1,8 1761	4 CYL ø83 XANTIA XSARA ZX 07/92-->09/00	101 PS / 74 KW	LFZ (XU7JP)	61233002 0197.G4+0209.E1	 61207005 0209.E1 1,30mm 1 61207006 0209.L8 1,50mm 2 ø84,5
1,8 1761	4 CYL ø83 XANTIA 16V XSARA PICASSO 16V XSARA 16V ZX ZX 16V 06/95-->	115 PS / 85 KW 110 PS / 81 KW	LFY (XU7JP4)		 62220005 0209.Q3 1,20mm 1 62220006 0209.V4 1,40mm 2 62220007 1,60mm 3 ø84
1,8 1769	4 CYL ø 84 C 25 07/87->02/94	69 PS / 51 KW	169 (XM7T)	61210001 0197.L1 0197.15	 61210005 0209.F8 ø86,7
1,9 1,905	4 CYL ø83 BX 19 BX 19 GTI ZX 06/88-->12/94 07/86-->12/94 12/87-->06/97	109 PS / 80 KW 102 PS / 75 KW 120 PS / 88 KW 95 PS / 70 KW 122 PS / 90 KW	DDZ (XU9M) DFZ (XU9J1) DKZ (XU9JA) D2C (XU92C) D2F D2A (XU92C) D2C (XU92C) D6A (XU9J2) 159A D6E (XU9JA)	61207002 0197.89+0209.E1 61207003 0197.H6+0209.E1	 61207005 0209.E1 1,30mm 1 61207006 0209.L8 1,50mm 2 ø84,5

▲ : İçerikte Bulunmamaktadır...

▲ : Not included in the set

▲ : Non inclus dans la pochette

00: Motor Takım Keçesiz ve Subap Lastiksiz











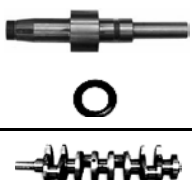
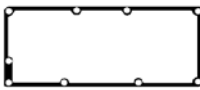





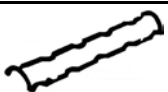



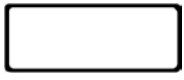



00: Gasket Set Without oil seals Without Valve Stem Seal

01: Motor Takım Keçesiz - Subap Lastikli

01: Gasket set With Valve Stem Seal Without Oil Seals

02: Motor Full Takım Keçeli ve Subap Lastikli

02: Gasket Full Set With oil seals and Valve Stem Seals

Subap Kapak Valve Cover Gasket Zylinderkopfhaube Couvre-culbut.	Karter Oil Pan Ölwanne Carter d'huile	Emme Manifold Intake Manifold Ansaug Admission	Egzoz Manifold Exhaust Manifold Auspuffkrümmer Collecteur D'echappement	Eksoz Boğaz Exhaust Pipe Auspuff Kehle	Supap Keçesi Valve Stem Seal Ventilschaft Queue de soupape	
						
 61233025 0249.71	 61203013 0304.34 93502226.	 61233018x4 0348.E6 + 0348F6	 61233020x4 1723.63		 60107027x8 0956.22 8x10,8/14,2x10	21201019 42x62x8 RD 21201040 90x110x10 LD 21201062 36x50x7 RD
 61210525 0249.14	 61210013 0304.44	 61211016 0348.33	 61210020 0349.03		 60107027x8 0956.22 8x10,8/14,2x10	
 61207525 0249.48 91508054	 61203013 0304.34 93502226  61203014 93501565	 61203018x2 91508659. BX->1984  61207018 951299280  61207019 0348.76	 61207020x4 0349.70 91505500  61205019 1721.01 7810024000	 61207017 1710.39 91511460	 60107027x8 0956.22 8x10,8/14,2x10	21201019 42x62x8 RD 21201040 90x110x10 LD 21201062 36x50x7 RD

 : Delik - Çentik

 : Hole - Notch

 : Trou - Entaille

NOT: Katalogdaki Orijinal Kodlar Referans Amacıyla Kullanılmıştır.Lütfen COTECH Kodlarını Kullanınız.
Original codes used for reference only.Please use COTECH codes for orders.

00



01



02



03



04



Silindir Kapak
Cylinder Head
Zylinderkopf
Joint de culasse

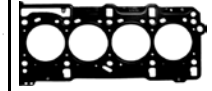

Ltr	MODEL	PS/KW	ENGINE/MOTOR		
1,9 1905	4 CYL ø83 BERLINGO D 09/83-->12/94 BX 19 D C25 C25 Bus D C25 D JUMPER Bus D JUMPER D JUMPY D XANTIA D XSARA D ZX D DIESEL	70 PS / 51 KW 64 PS / 47 KW 68 PS / 50 KW	DJY (XUD9A) DJZ (XUD9Y) D9B (XUD9A/L) D9B (XUD9A/U) DHY (XUD9TE/Y) D9A (XUD9) 162 (XUD9) 162 (XUD9) DJZ (XUD9) D9B (XUD9) 169B(XUD0) XUD9A 169B(XUD0) 169B(XUD0)	61204002 0197.H5 61204003 0197.H4 	61204009 0209.S5 1,36 mm 1 61204008 0209.S6 1,40 mm 2 61204007 0209.S7 1,44 mm 3 61204006 0209.S8 1,48 mm 4 61204005 0209.S9 1,53 mm 5 ø 84
1,9 1868	4 CYL ø82,2 BERLINGO D JUMPY D XSARA D	70 PS / 51 KW	DW8B WJY (DW8B) WJZ (DW8)	62173002 0197.X6 	62173005 0209.1C 1,47mm 62173006 0209.X4 1,42mm 5 62173007 0209.X3 1,38mm 4 62173008 0209.X2 1,34mm 3 62173009 0209.X1 1,30mm 2 62173010 0209.X0 1,26mm 1 MLS ø84
2,0 1971	4 CYL ø 88 C25 09/81-->03/94 C25 Bus	79 PS / 58 KW 84 PS / 62 KW	170A (XN1T) 170B (XN1T) 170C (XN1T)	61211001 9400197139	61211005 0209.46 1,20mm 61211006 1,80mm ø90

▲ : İçerikte Bulunmamaktadır...

▲ : Not included in the set

▲ : Non inclus dans la pochette

00: Motor Takım Keçesiz ve Subap Lastiksiz











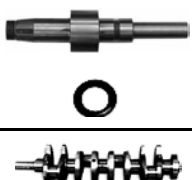
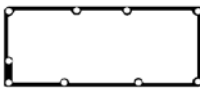





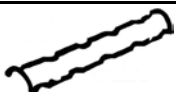







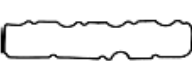

00: Gasket Set Without oil seals Without Valve Stem Seal

01: Motor Takım Keçesiz - Subap Lastikli

01: Gasket set With Valve Stem Seal Without Oil Seals

02: Motor Full Takım Keçeli ve Subap Lastikli

02: Gasket Full Set With oil seals and Valve Stem Seals

Subap Kapak Valve Cover Gasket Zylinderkopfhaube Couvre-culbut.	Karter Oil Pan Ölwanne Carter d'huile	Emme Manifold Intake Manifold Ansaug Admission	Egzoz Manifold Exhaust Manifold Auspuffkrümmer Collecteur D'echappement	Eksoz Boğaz Exhaust Pipe Auspuff Kehle	Supap Keçesi Valve Stem Seal Ventilschaft Queue de soupape	
						
 61203525 0249.46 0249.91	 61203013 0304.34  61203014 93501565	 61203116x2 0348.99  61203018x2 91508659  61203021 0348.JO	 61205019 1721.01 7810024000  61203120x2 0349.47 93010402		 60107027x8 0956.22 8x10,8/14,2x10	21201011x2 35x50x8 WD 21201019 42x62x8 RD 21201040 90x110x7 LD
 62173025 0249.95	 61203013 0304.34	 62173018x2 0348.N2	 62173021x2 0349.H7		 60107027x8 0956.22 8x10,8/14,2x10	21208023 35x50x8 RD 21201019 42x62x8 RD 21201040 90x110x10 LD
 61210525 0249.14	 61210013 0322.10 0304.11	 61211016 0348.33  61211015 0348.21	 61210020 0349.03	 61205017 1710.09	 60107027x8 0956.22 8x10,8/14,2x10	

 : Delik - Çentik

 : Hole - Notch

 : Trou - Entaille

NOT: Katalogdaki Orijinal Kodlar Referans Amacıyla Kullanılmıştır. Lütfen COTECH Kodlarını Kullanınız.
Original codes used for reference only. Please use COTECH codes for orders.

00



01



02



03



04



Silindir Kapak
Cylinder Head
Zylinderkopf
Joint de culasse

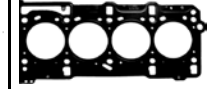

Ltr	MODEL	PS/KW	ENGINE/MOTOR		
2,0 1998	4 CYL ø86 EVASION 16V 05/98-->04/00 XANTIA 16V 06/95-->04/03 XM 16V 05/94-->10/00 XSARA 16V 07/98-->09/00	132 PS / 97 KW	RFV (XU10J4R)		 62170005 0209.N6 1,35 mm 1
					62170006 0209.T9 1,50mm 2 ø87
2,5 2500	4 CYL ø93 CX 25 D 02/78-->02/94 CX 25 TRI CX 2500 D C25 Bus D C25 D	136 PS / 100KW 73 PS / 54 KW	CRD93L (U25-661) M25-629 M25-659 M25-660	61215003 0197K1	 61215005 0209.L5 1,40mm ø95,5
2,5 2500	4 CYL ø93 CX 25 TD 04/83-->02/94 CX 2500 TD C25 Bus TD C25 DT	120 PS / 88 KW 95 PS / 75 KW	CRD93LS (U25-673) M25-648 M25-669	61215103 0197K1 TD	 61215105 0209.L6 1,40mm ø95,5
2,8 2798	4 CYL ø94.4 JUMPER HDI 09/04-->04/02 JUMPER HDI JUMPER 09/00-->06/06	128 PS / 94 KW 146 PS / 107 KW 87 PS / 64 KW	F28TDCR 8140.43N 8140.43S	60139100 0197.Z4 0197.Y9 0197.Y2	 60139005 0209.OF 1,50mm 60139006 0209.OE 1,40mm 60139007 0209.OC 1,30mm ø96

▲ : İçerikte Bulunmamaktadır...

▲ : Not included in the set

▲ : Non inclus dans la pochette

00: Motor Takım Keçesiz ve Subap Lastiksiz











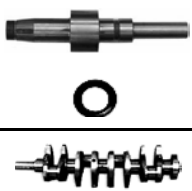
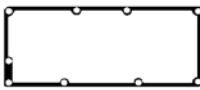





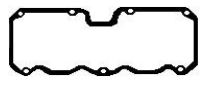

00: Gasket Set Without oil seals Without Valve Stem Seal

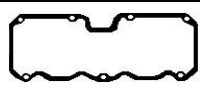
01: Motor Takım Keçesiz - Subap Lastikli

01: Gasket set With Valve Stem Seal Without Oil Seals

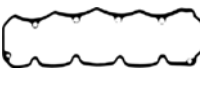
02: Motor Full Takım Keçeli ve Subap Lastikli

02: Gasket Full Set With oil seals and Valve Stem Seals

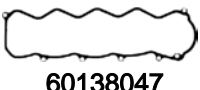
Subap Kapak Valve Cover Gasket Zylinderkopfhaube Couvre-culbut.	Karter Oil Pan Ölwanne Carter d'huile	Emme Manifold Intake Manifold Ansaug Admission	Egzoz Manifold Exhaust Manifold Auspuffkrümmer Collecteur D'echappement	Eksoz Boğaz Exhaust Pipe Auspuff Kehle	Supap Keçesi Valve Stem Seal Ventilschaft Queue de soupape	
						
 61215025 5 450 155		 61215019x4 0348.H0	 61215021x4 0349.F0	 61215017 95494600		
 61215025 5 450 155		 61215019x4 0348.H0	 61215021x4 0349.F0	 61215017 95494600		
 60138045 0249.A0	 60138068 500327440	 60146019x4 98425767	 60147021x4 98434020			
 60138047 0249.C3						

 : Delik - Çentik

 : Hole - Notch

 : Trou - Entaille

NOT: Katalogdaki Orijinal Kodlar Referans Amacıyla Kullanılmıştır.Lütfen COTECH Kodlarını Kullanınız.
Original codes used for reference only.Please use COTECH codes for orders.

00



01



02



03



04



Silindir Kapak
Cylinder Head
Zylinderkopf
Joint de culasse



Ltr	MODEL	PS/KW	ENGINE/MOTOR		
1,2 1149	4 CYL ø69 LOGAN 16V 2007-->	75 PS / 55 KW	D4DHIFLEX	60108703 77 01 475 822	 60108605 8200062273 MLS ø70
1,4 1390	4 CYL ø79,5 LOGAN SANDERO 09/04-->	75 PS / 55 KW 72 PS / 53 KW	K7J 710 K7J 714	60108902 Motor Full Takım Gasket Full Set 60108903 60 01 548 043 60149004 Motor Alt Takım Conversion Set	 60108905 82 00 296 969 1,20mm FIBER / FIBRE 60108906 82 00 296 969 MLS ø80,5
1,5 1461	4 CYL ø76 LOGAN DCI 09/05-->	65 PS / 48 KW	K9K 790	62456902 Motor Full Takım Gasket Full Set 62457003 77 01 476 729 62457104 Motor Alt Takım Conversion Set	 62457005 82 00 351 353 0,70mm 62457006 82 00 351 353 0,82mm MLS ø77,5
1,5 1461	4 CYL ø76 LOGAN DCI SANDERO DCI 01/06--> 09/07-->	68 PS / 50 KW 86 PS / 63 KW	K9K 792 K9K 796	62457002 Motor Full Takım Gasket Full Set 62457003 77 01 476 729 62457004 Motor Alt Takım Conversion Set	 62457005 82 00 351 353 0,70mm 62457006 82 00 351 353 0,82mm MLS ø77,5

▲ : İçerikte Bulunmamaktadır...

▲ : Not included in the set

▲ : Non inclus dans la pochette

00: Motor Takım Keçesiz ve Subap Lastiksiz











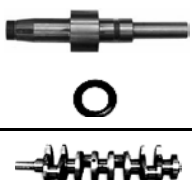
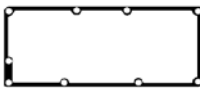









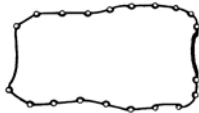

00: Gasket Set Without oil seals Without Valve Stem Seal

01: Motor Takım Keçesiz - Subap Lastikli

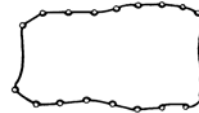
01: Gasket set With Valve Stem Seal Without Oil Seals

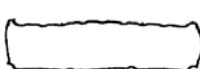
02: Motor Full Takım Keçeli ve Subap Lastikli

02: Gasket Full Set With oil seals and Valve Stem Seals

Subap Kapak Valve Cover Gasket Zylinderkopfhaube Couvre-culbut.	Karter Oil Pan Ölwanne Carter d'huile	Emme Manifold Intake Manifold Ansaug Admission	Egzoz Manifold Exhaust Manifold Auspuffkrümmer Collecteur D'echappement	Eksoz Boğaz Exhaust Pipe Auspuff Kehle	Supap Keçesi Valve Stem Seal Ventilschaft Queue de soupape	
						
 60108725 77 01 059 314		 60108618 77 01 473 007	 60108621 77 00 115 971		 60108726x16 82 00 171 215 5,5x8,3x11,5x8	21204701 28x47x8 RD
 60116527 77 01 471 719	 62457165 77 00 273 486	 60108918x4 77 01 471 932	 60108921 8200191371		 60116026x8 77 00 103 872 7x9,8/13.2x10	21208003 30x42x7 RD 21208001 35x47x7 RD 21208012 80x100x8 LD
 62457125 82 00 317 650	 62457165 77 00 273 486		 62457021 82 00 414 346		 62457144x8 77 00 109 840 6x8,8x12,2x9,7	21204024 28x42x5 RD 21204025 35x47x7 RD 21204033 80x100x9 LD
 62457125 82 00 317 650	 62457065 82 00 379 654		 62457021 82 00 414 346		 62457144x8 77 00 109 840 6x8,8x12,2x9,7	21204024 28x42x5 RD 21204025 35x47x7 RD 21204033 80x100x9 LD

 : Delik - Çentik

 : Hole - Notch

 : Trou - Entaille

NOT: Katalogdaki Orijinal Kodlar Referans Amacıyla Kullanılmıştır.Lütfen COTECH Kodlarını Kullanınız.
Original codes used for reference only.Please use COTECH codes for orders.

DACIA

00



Silindir Kapak
Cylinder Head
Zylinderkopf
Joint de culasse

01



02



03



04

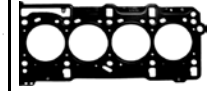

Ltr	MODEL	PS/KW	ENGINE/MOTOR		
1,5 1461	4 CYL ø76 DUSTER 05/10--> LOGAN DCI SANDERO DCI DOKKER DCI 11/12-->	107 PS / 79 KW 75 PS / 55 KW	K9K 892 K9K 894 K9K 896 K9K 898 K9K 612	62457503 77 01 479 013	 62457505 11 04 470 55R 0,85mm MLS ø77,5
1,6 1598	4 CYL ø79,5 LOGAN 16V 02/06-->	105 PS / 77 KW	K4M 690 K4M 694	62456602 Motor Full Takım Gasket Full Set 62456603 77 01 471 886 62457204 Alt Takım Conversion Set	 62457205 77 00 112 739 MLS ø80,5
1,6 1598	4 CYL ø79,5 LOGAN 09/04--> SANDERO 06/08-->	105 PS / 77 KW 84 PS / 62 KW 87 PS / 62 KW	K7M 690 K7M 710 K7M 718 K7M 732	60108902 Motor Full Takım Gasket Full Set 60108903 60 01 548 043 60149004 Motor Alt Takım Conversion Set	 60108905 82 00 296 969 1,20mm FIBER / FIBRE 60108906 82 00 296 969 MLS ø80,5

▲ : İçerikte Bulunmamaktadır...

▲ : Not included in the set

▲ : Non inclus dans la pochette

00: Motor Takım Keçesiz ve Subap Lastiksiz











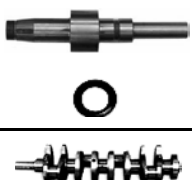
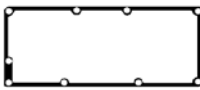







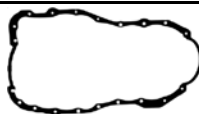

00: Gasket Set Without oil seals Without Valve Stem Seal

01: Motor Takım Keçesiz - Subap Lastikli

01: Gasket set With Valve Stem Seal Without Oil Seals

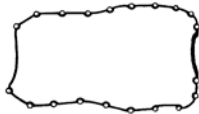
02: Motor Full Takım Keçeli ve Subap Lastikli

02: Gasket Full Set With oil seals and Valve Stem Seals

Subap Kapak Valve Cover Gasket Zylinderkopfhaube Couvre-culbut.	Karter Oil Pan Ölwanne Carter d'huile	Emme Manifold Intake Manifold Ansaug Admission	Egzoz Manifold Exhaust Manifold Auspuffkrümmer Collecteur D'echappement	Eksoz Boğaz Exhaust Pipe Auspuff Kehle	Supap Keçesi Valve Stem Seal Ventilschaft Queue de soupape	
						
						21204710 28x42x6 RD
62457525 77 01 070 607	62457065 82 00 379 654		62457021 82 00 414 346		62457144x8 77 00 109 840 82 00 496 321 6x8,8x12,2x9,7	21204025 35x47x7 RD 21204033 80x100x9 LD
						21204024x2 28x42x5 RD
	62457265 77 00 103 687	62457418x4 82 00 275 057	62457222 82 00 365 915		62457244x16 77 00 103 938 5,5x11x28x16,4	21204005 35x47x7 RD 21204009 80x100x8 LD
						
						21208003 30x42x7 RD
60116527 77 01 471 719	62457165 77 00 273 486	60108918x4 77 01 471 932	60108921 8200191371		60116026x8 77 00 103 872 7x9,8/13.2x10	21208001 35x47x7 RD 21208012 80x100x8 LD

■ : Delik - Çentik

■ : Hole - Notch

■ : Trou - Entaille

NOT: Katalogdaki Orijinal Kodlar Referans Amacıyla Kullanılmıştır.Lütfen COTECH Kodlarını Kullanınız.
Original codes used for reference only.Please use COTECH codes for orders.

00



01



02



03



04



Silindir Kapak
Cylinder Head
Zylinderkopf
Joint de culasse

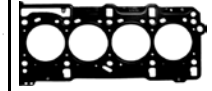

Ltr	MODEL	PS/KW	ENGINE/MOTOR		
0,8	3 CYL ø68,5 MATIZ TICO SPARK (SOHC) 01/96-->12/00	52 PS / 38 KW 48 PS / 35 KW	F8CV F8CV		 61460105 11141A78B01-00 2,00mm ø69,5
1,4 1349	4 CYL ø77,6 LANOS 05/97-->	75 PS / 55 KW	A13DM A14SMS A13SMS	62447103 1606730	 62447205 607449 1,80mm ø79,5
1,4 1393	4 CYL ø77,9 KALOS AVEO (SOHC) 1102-->12/04	83 PS / 61KW	F14S3		 62447305 5607408-607988 1,40mm ø80,5
1,4 1399	4 CYL ø77,9 KALOS OPTRA LACETTI (DOCH16V) 10/03-->12/05	94 PS / 69 KW	F14D3 F14D5		 62450205 96378802 1,20mm FIBER / FIBRE ø80
1,4 1399	4 CYL ø77,9 AVEO LACETTI NUBIRA OPTRA KALOS (DOCH 16 V) 03/05-->12/07	94 PS / 69 KW	F14D3		 62450105 96473400 1,20mm FIBER / FIBRE ø80
1,5 1498	4 CYL ø76,5 ESPERO CIELO NEXIA (DOCH 16V) 02/95-->06/99	90 PS / 6 KKW	A15MF		 61504005 96391435 1,40mm 61504006 96391435 2,00mm ø78

▲ : İçerikte Bulunmamaktadır...

▲ : Not included in the set

▲ : Non inclus dans la pochette

00: Motor Takım Keçesiz ve Subap Lastiksiz









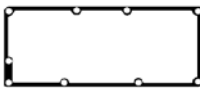

00: Gasket Set Without oil seals Without Valve Stem Seal

01: Motor Takım Keçesiz - Subap Lastikli

01: Gasket set With Valve Stem Seal Without Oil Seals

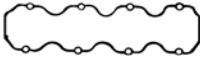
02: Motor Full Takım Keçeli ve Subap Lastikli

02: Gasket Full Set With oil seals and Valve Stem Seals

Subap Kapak Valve Cover Gasket Zylinderkopfhaube Couvre-culbut.	Karter Oil Pan Ölwanne Carter d'huile	Emme Manifold Intake Manifold Ansaug Admission	Egzoz Manifold Exhaust Manifold Auspuffkrümmer Collecteur D'echappement	Eksoz Boğaz Exhaust Pipe Auspuff Kehle	Supap Keçesi Valve Stem Seal Ventilschaft Queue de soupape	
						
						
62447236 638 260 Kauçuk Rubber		62447319 850 607	62447221 850 615		62447227x8 642527 7x11,1/16x10	21201014 35x48x7 RD

 : Delik - Çentik

 : Hole - Notch

 : Trou - Entaille

NOT: Katalogdaki Orijinal Kodlar Referans Amacıyla Kullanılmıştır.Lütfen COTECH Kodlarını Kullanınız.
Original codes used for reference only.Please use COTECH codes for orders.

00



01



02



03



04



Silindir Kapak
Cylinder Head
Zylinderkopf
Joint de culasse



Ltr	MODEL	PS/KW	ENGINE/MOTOR		
1,5 1498	4 CYL ø77,6 LACETTI 04/97--> LANOS NUBIRA	110 PS / 81 KW 86 PS / 63 KW	A15DMS A15SMS	62447103 1606730	 62447205 607449 1,80mm ø79,5
1,5 1498	4 CYL ø79 NEXIA 07/94-->08/97 ESPERO CIELO LEMANS	78 PS / 57 KW 60 PS / 44 KW	G15MF 16SV	62447302 Motor Full Takım Gasket Full Set 62447303 1606673+1606689 62447204 1606728+1606686	 62447305 5607408-607988 1,40mm ø80,5
1,6 1598	4 CYL ø79 AVEO 07/03-->03/05 KALOS NUBIRA OPTRA LACETTI (DOCH 16V)	109 PS / 80 KW	F16D3		 62450205 96378802 1,20mm FIBER / FIBRE ø80
1,8 1796	4 CYL ø84,8 ESPERO 02/95-->07/03 LACETTI 08/92-->08/95 LEGANZA SUPER SALOON PRINCE ARANOS (SOHC)	95 PS / 70 KW 90 PS / 60 KW 101 PS / 70 KW	C18LE S 18 NV	62447502 Motor Full Takım Gasket Full Set 62447503 1606666 62447504 1606663	 62447505 607986 1,40mm ø86,3
1,8 1799	4 CYL ø81,6 LACETTI 16 V 07/03--> NUBIRA 16 V	122 PS / 90 KW	T18SED	62448603 1606914	 62448605 608809 1,40mm ø83

▲ : İçerikte Bulunmamaktadır...

▲ : Not included in the set

▲ : Non inclus dans la pochette

00: Motor Takım Keçesiz ve Subap Lastiksiz











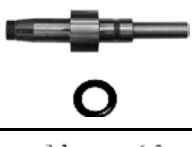
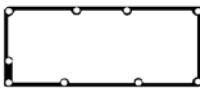





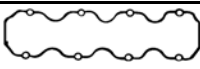









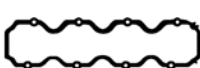

00: Gasket Set Without oil seals Without Valve Stem Seal

01: Motor Takım Keçesiz - Subap Lastikli

01: Gasket set With Valve Stem Seal Without Oil Seals

02: Motor Full Takım Keçeli ve Subap Lastikli

02: Gasket Full Set With oil seals and Valve Stem Seals

Subap Kapak Valve Cover Gasket Zylinderkopfhaube Couvre-culbut.	Karter Oil Pan Ölwanne Carter d'huile	Emme Manifold Intake Manifold Ansaug Admission	Egzoz Manifold Exhaust Manifold Auspuffkrümmer Collecteur D'echappement	Eksoz Boğaz Exhaust Pipe Auspuff Kehle	Supap Keçesi Valve Stem Seal Ventilschaft Queue de soupape	
						
 62447236 638 260 Kauçuk Rubber		 62447319 850 607	 62447221 850 615		 62447227x8 642527 7x11,1/16x10	21201014 35x48x7 RD
 62447235 638727	 62447265 652577	 62447219 850634	 62447221 850 615	 62447517 854933	 62447227x8 642527 7x11,1/16x10	21201014 35x48x7 RD 21208007 26x42x8 RD 21208013 80x98x10 LD
 62447534 638192	 62447564 652587	 62447518 850600  62447719 850601	 62447521 850645	 62447517 854933	 62447227x8 642527 7x11,1/16x10	21201014 35x48x7 RD 21208020 31x50x8 RD 21208019 90x104x11 LD
 62447625 607647		 62447619 850655	 62447621 850656	 62447517 854933	 62447426x16 6x8,8x12,2x9,7	21201014 35x48x7 RD 2x

■ : Delik - Çentik

■ : Hole - Notch

■ : Trou - Entaille

NOT: Katalogdaki Orijinal Kodlar Referans Amacıyla Kullanılmıştır.Lütfen COTECH Kodlarını Kullanınız.
Original codes used for reference only.Please use COTECH codes for orders.

00



Silindir Kapak
Cylinder Head
Zylinderkopf
Joint de culasse

01



02



03



04

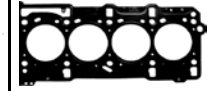

Ltr	MODEL	PS/KW	ENGINE/MOTOR		
2,0 1998	4 CYL ø86 ESPERO 10/93-->06/99 LEGANZA LEMANS RACER PRINCE MAGNUS COMPACT ARANOS NUBIRA II (SOHC)	110 PS / 81 KW 105 PS / 77 KW	C20LE C20NE	62447700 62447702 Motor Full Takım Gasket Full Set 62447703 1606664 62447504 1606663	 62447705 607987 1,30mm ø87,5
2,0 1998	4 CYL ø86 LEGANZA 16 V 05/97--> NUBIRA II 16 V 07/00--> LACETTI 16 V MAGNUS 16 V REZZO 16 V (DOHC)	126 PS / 93 KW 133 PS / 98 KW 121 PS / 89 KW	T20SED X 20 SED Z20L X22SED	62447603 1606770	 62447605 5607449 1,30mm ø87,5

▲ : İçerikte Bulunmamaktadır...

▲ : Not included in the set

▲ : Non inclus dans la pochette

00: Motor Takım Keçesiz ve Subap Lastiksiz











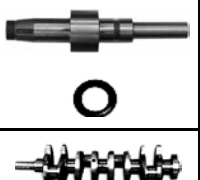
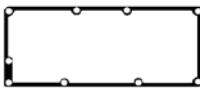

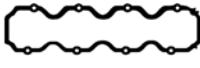

00: Gasket Set Without oil seals Without Valve Stem Seal

01: Motor Takım Keçesiz - Subap Lastikli

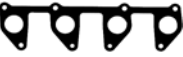
01: Gasket set With Valve Stem Seal Without Oil Seals

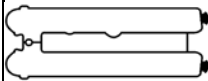
02: Motor Full Takım Keçeli ve Subap Lastikli

02: Gasket Full Set With oil seals and Valve Stem Seals

Subap Kapak Valve Cover Gasket Zylinderkopfhaube Couvre-culbut.	Karter Oil Pan Ölwanne Carter d'huile	Emme Manifold Intake Manifold Ansaug Admission	Egzoz Manifold Exhaust Manifold Auspuffkrümmer Collecteur D'echappement	Eksoz Boğaz Exhaust Pipe Auspuff Kehle	Supap Keçesi Valve Stem Seal Ventilschaft Queue de soupape	
						
 62447534 638192	 62447564 652587	 62447719 850601	 62447521 850645	 42447517 854933	 62447227x8 642527 7x11,1/16x10	21201014 35x48x7 RD
 62447625 607647		 62447619 850655	 62447621 850656		 62447426x16 642533 6x8.8x12.2x9.7	21208020 31x50x8 RD
						21208019 90x104x11 LD
						21201014x2 35x48x7 RD

 : Delik - Çentik

 : Hole - Notch

 : Trou - Entaille

NOT: Katalogdaki Orijinal Kodlar Referans Amacıyla Kullanılmıştır.Lütfen COTECH Kodlarını Kullanınız.
Original codes used for reference only.Please use COTECH codes for orders.

00



01



02



03



04



Silindir Kapak
Cylinder Head
Zylinderkopf
Joint de culasse



Ltr	MODEL	PS/KW	ENGINE/MOTOR	
1,0 993	3 CYL ø76 CHARADE 03/87-->12/92	52 PS / 38 KW	CB12 CB23 CB37 CBT50	 61460005 11115-87714 1,80mm ø77,5
1,6 1587	4 CYL ø80,5 DELTA TAFT 09/72-->02/85	67 PS / 49 KW	12R	 61411505 11115-31020 1,80mm 61411506 11115-31020 2,0mm ø83
1,8 1812	4 CYL ø86 DELTA WIDE 02/85-->	88 PS / 65 KW	2Y	 61411605 11115-71010 1,80mm 61411606 11115-71010 2,0mm ø88
2,0 1998	4 CYL ø86 DELTA WIDE ROCKY RUGGER TAFT 02/85-->04/93	88 PS / 65 KW	3Y	 61411605 11115-71010 1,80mm 61411606 11115-71010 2,0mm ø88
2,2 2237	4 CYL ø91 ROCKY 05/93-->06/01	88 PS / 65 KW	4Y	 61411105 11115-73010 1,60mm 61411106 11115-73010 2,00mm ø93

▲ : İçerikte Bulunmamaktadır...

▲ : Not included in the set

▲ : Non inclus dans la pochette

00: Motor Takım Keçesiz ve Subap Lastiksiz







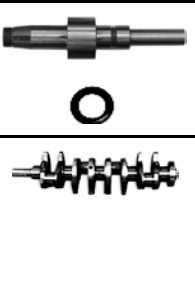
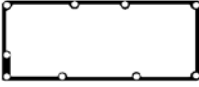

00: Gasket Set Without oil seals Without Valve Stem Seal

01: Motor Takım Keçesiz - Subap Lastikli

01: Gasket set With Valve Stem Seal Without Oil Seals

02: Motor Full Takım Keçeli ve Subap Lastikli

02: Gasket Full Set With oil seals and Valve Stem Seals

Subap Kapak Valve Cover Gasket Zylinderkopfhaube Couverculbut.	Karter Oil Pan Ölwanne Carter d'huile	Emme Manifold Intake Manifold Ansaug Admission	Egzoz Manifold Exhaust Manifold Auspuffkrümmer Collecteur D'echappement	Eksoz Boğaz Exhaust Pipe Auspuff Kehle	Supap Keçesi Valve Stem Seal Ventilschaft Queue de soupape	
						
		 <p>61415720 17172-71010</p>				
		 <p>61415720 17172-71010</p>				

■ : Delik - Çentik

■ : Hole - Notch

■ : Trou - Entaille

NOT: Katalogdaki Orijinal Kodlar Referans Amacıyla Kullanılmıştır.Lütfen COTECH Kodlarını Kullanınız.
Original codes used for reference only.Please use COTECH codes for orders.

00



Silindir Kapak
Cylinder Head
Zylinderkopf
Joint de culasse

01



02



03



04

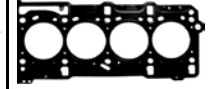

Ltr	MODEL	PS/KW	ENGINE/MOTOR		
0,8 767	4 CYL ø62 600 D 10/60-->02/70 600 E 600 T 770 S 10/60-->08/68 2 Serie Furgoneta	23 PS / 17 KW 25 PS / 18 KW	100 D.000 100 D.000	63113002 588041+4387608 63113000 588041	 63113005 4387608 1,20mm 63113006 4064640 1,80mm ø64
0,8 843	4 CYL ø65 850 07/64-->10/72 850 VAN 03/68-->10/72 Furgoneta Special T Familiare Van	35 PS / 25 KW 48 PS / 35 KW	100 G.000 100 G.000	60313002 5880412 5881112 60313000 5880412 5881112	 60313005 7745836 1,20mm 60313006 7539220 1,80mm ø66
0,9 903	4 CYL ø65 850 02/68-->12/72 900 E 01/78-->01/86 900 T 01/78-->01/86 Panorama Pulmino Spider Sport Coupe T Familiare	32 PS / 24 KW 52 PS / 38 KW 35 PS / 26 KW	100 G.000 100 G.000 100 G.000	60313002 5880412 5881112 60313000 5880412 5881112	 60313005 7745836 1,20mm 60313006 7539220 1,80mm ø66
0,9 903	4 CYL ø65 127 ESPECIAL 1974--> PANDA 34 10/1980-->06/1994 PANDA 35 10/1980-->06/1994 PANDA 4x2 10/1980-->06/1994 UNO 45 1988--> PANDA 10/80-->06/94	34 PS / 25 KW 45 PS / 33 KW	146 A.000 146 A.048 100 CL3.000		 60313005 7745836 1,20mm 60313006 7539220 1,80mm ø66

▲ : İçerikte Bulunmamaktadır...

▲ : Not included in the set

▲ : Non inclus dans la pochette

00: Motor Takım Keçesiz ve Subap Lastiksiz











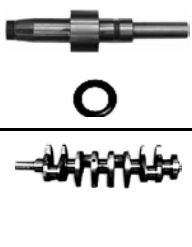
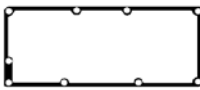





00: Gasket Set Without oil seals Without Valve Stem Seal

01: Motor Takım Keçesiz - Subap Lastikli

01: Gasket set With Valve Stem Seal Without Oil Seals

02: Motor Full Takım Keçeli ve Subap Lastikli

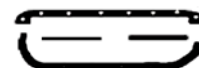
02: Gasket Full Set With oil seals and Valve Stem Seals

Subap Kapak Valve Cover Gasket Zylinderkopfhaube Couvre-culbut.	Karter Oil Pan Ölwanne Carter d'huile	Emme Manifold Intake Manifold Ansaug Admission	Egzoz Manifold Exhaust Manifold Auspuffkrümmer Collecteur D'echappement	Eksoz Boğaz Exhaust Pipe Auspuff Kehle	Supap Keçesi Valve Stem Seal Ventilschaft Queue de soupape	
						
 60313034 4145587	 60313013 5882343	 60313020 4127971				21201064 42x56x7 LD 21201065 64x80x8 RD
 60313034 4145587	 60313013 5882343	 60313020 4127971				21201064 42x56x7 LD 21201065 64x80x8 RD
 60313034 4145587	 60313013 5882343	 60313020 4127971				21201064 42x56x7 LD 21201065 64x80x8 RD

 : Delik - Çentik

 : Hole - Notch

 : Trou - Entaille

NOT: Katalogdaki Orijinal Kodlar Referans Amacıyla Kullanılmıştır.Lütfen COTECH Kodlarını Kullanınız.
Original codes used for reference only.Please use COTECH codes for orders.

00



01



02



03



04



Silindir Kapak
Cylinder Head
Zylinderkopf
Joint de culasse

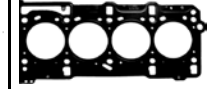

Ltr	MODEL	PS/KW	ENGINE/MOTOR		
1,0 999	4 CYL ø70 PANDA 01/86-->12/92 PANDA 1000 05/86-->03/95 PANDA 45 05/86-->03/95 UNO 45 05/86-->03/95 45 Fire SPI	45 PS / 33 KW 50 PS / 37 KW 45 PS / 33 KW	156 A2.000 156 A2.100 156 A2.146 141 C2.000 156 A3.000 156 A3.100 156 A2.246 156.A2.048 146.A2.166 146.D8.000	60340102 5892376 60340100 5892376 60340103 5882345	 60340005 7640784 1,80mm ø71,5
1,0 1049	4 CYL ø76 127 09/71-->02/82 127 09/79-->02/82 FIORINO RITMO STRADA 60 No:475521-->	70 PS / 51 KW 60 PS / 44 KW	127 A1.000 127 A6.000 127 A.000	63114002 5891802 5891843 63114000 5891802 5891843	 63114005 5960967 1,20mm 63114006 5960968 1,80mm ø77
1,0 1049	4 CYL ø76 127 09/71-->02/82 127 09/79-->02/82 FIORINO RITMO STRADA 60 No:475520 <--	70 PS / 51 KW 60 PS / 44 KW	127 A1.000 127 A6.000 127 A.000	63114102 5882059 63114100 5882059	 63114005 5960967 1,20mm 63114006 5960968 1,80mm ø77
1,1 1108	4 CYL ø70 TIPO 01/89-->09/99 UNO 01/89-->09/99 PANDA 10/94-->01/98 PUNTO 55 01/93-->09/99 CINQUENTO 10/94-->01/98 SEICENTO 01/95-->	54 PS / 40 KW 49 PS / 36 KW	160 A3.000 176 A6.000 176 B2.000 156 C.046 146 C3.000 156 B2.000 178 B9.033	60340002 5893658 60340001 5893658 60340003 5888218	 60340005 7640784 1,80mm ø71,5

▲ : İçerikte Bulunmamaktadır...

▲ : Not included in the set

▲ : Non inclus dans la pochette

00: Motor Takım Keçesiz ve Subap Lastiksiz











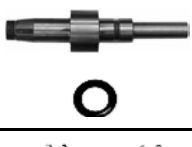
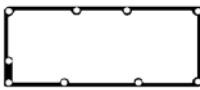









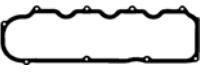

00: Gasket Set Without oil seals Without Valve Stem Seal

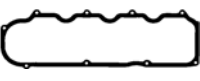
01: Motor Takım Keçesiz - Subap Lastikli

01: Gasket set With Valve Stem Seal Without Oil Seals

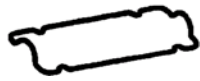
02: Motor Full Takım Keçeli ve Subap Lastikli

02: Gasket Full Set With oil seals and Valve Stem Seals

Subap Kapak Valve Cover Gasket Zylinderkopfhaube Couvre-culbut.	Karter Oil Pan Ölwanne Carter d'huile	Emme Manifold Intake Manifold Ansaug Admission	Egzoz Manifold Exhaust Manifold Auspuffkrümmer Collecteur D'echappement	Eksoz Boğaz Exhaust Pipe Auspuff Kehle	Supap Keçesi Valve Stem Seal Ventilschaft Queue de soupape	
						
 60340025 7688450		 60340119 7597583	 60340120x4 7579740		 60116026x8 5930415 7x9,8/13.2x10	21208003 30x42x7 RD
						21201072 23x35x7 RD
						21201053 70x88x8 LD
 63114034 4323710	 63114013 4249510	 63114020x2 4398359			 60107027x8 7553637 8x10,8x14,2x10	21201006 30x52x7 RD
						21201017 40x56x7 RD
						21201063 70x85x8 LD
 63114034 4323710	 63114013 4249510	 63114020x2 4398359			 60107027x8 7553637 8x10,8x14,2x10	21201006 30x52x7 RD
						21201017 40x56x7 RD
						21201030 64x80x8 LD
 60340025 7688450		 60340019 46426046 46754320	 60340020x2 7749711		 60116026x8 5930415 7x9,8/13.2x10	21208003 30x42x7 RD
						21201072 23x35x7 RD
						21201053 70x88x8 LD

■ : Delik - Çentik

■ : Hole - Notch

■ : Trou - Entaille

NOT: Katalogdaki Orijinal Kodlar Referans Amacıyla Kullanılmıştır.Lütfen COTECH Kodlarını Kullanınız.
Original codes used for reference only.Please use COTECH codes for orders.

FIAT

00



01



02



03



04



Silindir Kapak
Cylinder Head
Zylinderkopf
Joint de culasse

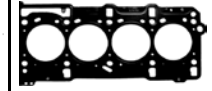

Ltr	MODEL	PS/KW	ENGINE/MOTOR		
1,1 1108	4 CYL ø70 PANDA 02/95-->09/03 PANDA 4x2 09/03--> PANDA 4x4 09/03--> SEICENTO 01/98-->01/10	54 PS / 40 KW	187 A1.000	60340402 71716869 60340401 71716869 60340403 71718390	 60340005 7640784 1,80mm ø71,5
1,1 1108	4 CYL ø70 PANDA 02/95-->07/04 PALIO TIPO 01/88-->10/91 UNO 60 04/89-->12/92 Fire SPI	50 PS / 37 KW 54 PS / 40 KW 56 PS / 41 KW 57 PS / 42 KW	145 C.046 176 B2.000 178 B9.033 160 A.3000	60340102 5892376 60340100 5892376 60340103 5882345	 60340005 7640784 1,80mm ø71,5
1,1 1116	4 CYL ø80 128 03/69-->12/84 RITMO 60 1978-->1982 STRADA 1979-->1982 60 L-CL Pick-Up Todos Tipos Motor All Engine Types Tous Types de Moteur	55 PS / 40 KW 60 PS / 44 KW 45 PS / 33 KW	128 A 138 A.000 128 AC5.000 128 A.048	60306002 5881135 60306000 5881135	 60306005 4387618 1,20mm ø81
1,1 1116	4 CYL ø80 128 03/69-->12/84 RITMO 60 1978-->1982 STRADA 1979-->1982 60 L-CL Pick-Up Todos Tipos Motor All Engine Types Tous Types de Moteur	55 PS / 40 KW 60 PS / 44 KW 45 PS / 33 KW	128 A 138 A.000 128 AC5.000 128 A.048	60306102 60306100	 60306006 4406740 1,80mm ø81
1,2 1197	4 CYL ø73 124 02/73-->07/75 Berlina	65 PS / 48 KW	124 A.000	60301002 5880424	 60301005 4387614 1,20mm ø78

▲ : İçerikte Bulunmamaktadır...

▲ : Not included in the set

▲ : Non inclus dans la pochette

00: Motor Takım Keçesiz ve Subap Lastiksiz











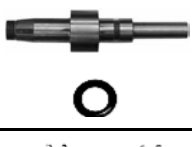
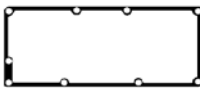









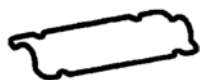



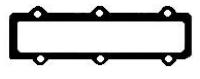
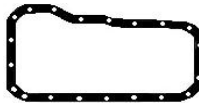



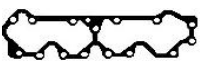
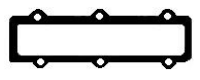

00: Gasket Set Without oil seals Without Valve Stem Seal

01: Motor Takım Keçesiz - Subap Lastikli

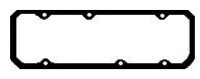
01: Gasket set With Valve Stem Seal Without Oil Seals

02: Motor Full Takım Keçeli ve Subap Lastikli

02: Gasket Full Set With oil seals and Valve Stem Seals

Subap Kapak Valve Cover Gasket Zylinderkopfhaube Couvre-culbut.	Karter Oil Pan Ölwanne Carter d'huile	Emme Manifold Intake Manifold Ansaug Admission	Egzoz Manifold Exhaust Manifold Auspuffkrümmer Collecteur D'echappement	Eksoz Boğaz Exhaust Pipe Auspuff Kehle	Supap Keçesi Valve Stem Seal Ventilschaft Queue de soupape	
						
 60340025 7688450		 60340418 71716684	 60340020x2 7749711		 60116026x8 5930415 7x9,8/13.2x10	21208003 30x42x7 RD
 60340025 7688450		 60340119 7597583	 60340120x4 7579740		 60116026x8 5930415 7x9,8/13.2x10	21201072 23x35x7 RD
						21204081 74x88x8 LD
 60304034 4448677	 60306013 4179038	 60306020x2 4309031	 60301018 4147260	 60107027x8 7553637 8x10,8x14,2x10	 21208003 30x42x7 RD	21201072 23x35x7 RD
 60304035 7784728						21201053 70x88x8 LD
 60304034 4448677	 60306013 4179038	 60306020x2 4309031	 60301018 4147260	 60107027x8 7553637 8x10,8x14,2x10	 21201006 30x52x7 RD	21201017 40x56x7 RD
 60304035 7784728						21201030 64x80x8 LD
 60301034 4130541	 60301013 4129756	 60301020x2 4177631	 60301018 4147260	 60107027x8 7553637 8x10,8x14,2x10	 21201006 30x52x7 RD	21201017 40x56x7 LD
						21201066 70x90x10 RD

■ : Delik - Çentik

■ : Hole - Notch

■ : Trou - Entaille

NOT: Katalogdaki Orijinal Kodlar Referans Amacıyla Kullanılmıştır.Lütfen COTECH Kodlarını Kullanınız.
Original codes used for reference only.Please use COTECH codes for orders.

FIAT

00



01



02



03



04



Silindir Kapak
Cylinder Head
Zylinderkopf
Joint de culasse

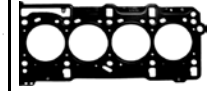

Ltr	MODEL	PS/KW	ENGINE/MOTOR		
1,2 1242	4 CYL ø70,8 PUNTO 60 01/94-->09/99 PUNTO SELECT/ 01/94-->09/99 PUNTO 75 11/93--> PALIO 75 01/94-->09/99 SIENA 04/96--> PUNTO 60 CABRIO	58 PS / 43 KW 73 PS / 54 KW 75 PS / 55 KW 60 PS / 44 KW	176 A7.000 176 A8.000 176 B1.000 176 A7.000 176 B4.000	60340202 5893660 60340201 5893660 60340203 5893663 5893661	 60340005 7640784 1,80mm ø71,5
1,2 1242	4 CYL ø70,8 PUNTO 16V 1997-->1999 MAREA 16V 1999--> PUNTO CABRIO 16 V BRAVA 12/98-->10/00 BRAVO 12/98-->10/00 STILO 02/02--> Active Dynamic	86 PS / 63 KW 82 PS / 60 KW	182 B2.000 176 B9.000 182 A2.000		 62427907 46434596 1,80mm ø72
1,2 1242	4 CYL ø70,8 BRAVA 16V 10/00-->10/01 BRAVO 16V 10/00-->10/01 IDEA 16V 09/99--> PUNTO 16V 10/97-->09/99 STILO 16V 09/99-->	80 PS / 59 KW 82 PS / 60 KW	188 A5.000 176 B9.000	60340302 71716871	 62427907 46434596 1,80mm ø72
1,2 1242	4 CYL ø70,8 PUNTO 09/99--> DOBLO 03/01--> PANDA 09/03--> STRADA 10/99-->03/03	60 PS / 44 KW 65 PS / 48 KW	188 A4.000 223 A5.000	60340402 71716869 71728827 60340401 71716869 71728827 60340403 71718390	 60340005 7640784 1,80mm ø71,5
1,2 1242	4 CYL ø70,8 PALIO 02/01--> DOBLO 03/01--> ALBEA 09/01--> PUNTO 09/99--> PANDA 09/99-->	60 PS / 44 KW 65 PS / 48 KW 60 PS / 44 KW	188 A4.000 199 A4.000 223 A5.000 178 B7.045 178 C4.066	62428102 71716869 62428103 71736240	 62428005 55183371 MLS ø72

▲ : İçerikte Bulunmamaktadır...

▲ : Not included in the set

▲ : Non inclus dans la pochette

00: Motor Takım Keçesiz ve Subap Lastiksiz











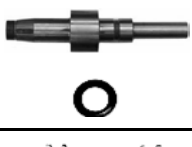
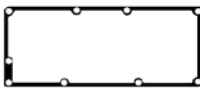











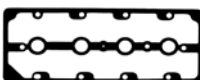

00: Gasket Set Without oil seals Without Valve Stem Seal

01: Motor Takım Keçesiz - Subap Lastikli

01: Gasket set With Valve Stem Seal Without Oil Seals

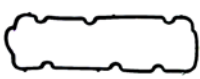
02: Motor Full Takım Keçeli ve Subap Lastikli

02: Gasket Full Set With oil seals and Valve Stem Seals

Subap Kapak Valve Cover Gasket Zylinderkopfhaube Couvre-culbut.	Karter Oil Pan Ölwanne Carter d'huile	Emme Manifold Intake Manifold Ansaug Admission	Egzoz Manifold Exhaust Manifold Auspuffkrümmer Collecteur D'echappement	Eksoz Boğaz Exhaust Pipe Auspuff Kehle	Supap Keçesi Valve Stem Seal Ventilschaft Queue de soupape	
						
 60340025 7688450		 60340019 46426046 46754320  60340018 46432735	 60340020x2 7749711	 60340017 46465291	 60116026x8 5930415 7x9,8/13.2x10	21208003 30x42x7 RD 21201072 23x35x7 RD 21204081 74x88x8 LD
 62427925 55194045		 62427918 71729223	 62427921 7749710		 62427426x16 46470334 6x8,8x11,7x9,5	21208048 27x37x7 RD 21208049 40x55x7 RD
 60340025 7688450		 60340418 71716684	 60340020x2 7749711		 60116026x8 5930415 7x9,8/13.2x10	21208003 30x42x7 RD 21201072 23x35x7 RD 21204081 74x88x8 LD
 60340027		 60340418 71716684	 60340020x2 7749711		 60116026x8 5930415 7x9,8/13.2x10	21208003 30x42x7 RD 21201072 23x35x7 RD 21208041 74x88x8 LD

■ : Delik - Çentik

■ : Hole - Notch

■ : Trou - Entaille

NOT: Katalogdaki Orijinal Kodlar Referans Amacıyla Kullanılmıştır.Lütfen COTECH Kodlarını Kullanınız.
Original codes used for reference only.Please use COTECH codes for orders.

00



01



02



03



04



Silindir Kapak
Cylinder Head
Zylinderkopf
Joint de culasse

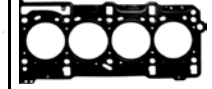

Ltr	MODEL	PS/KW	ENGINE/MOTOR		
1,2 1242	4 CYL ø70,8 PALIO 06/98--> PUNTO 03/94-->09/99 PUNTO 03/94-->09/99 PUNTO 11/99--> PUNTO 60 08/95--> PUNTO 75 04/96--> SIENA 04/96--> CABRIO 05/95-->06/00 Fire SPI Inyección	73 PS / 54 KW 60 PS / 44 KW 60 PS / 44 KW 73 PS / 54 KW 60 PS / 44 KW 73 PS / 53 KW 73 PS / 53 KW 60 PS / 44 KW	178 E2.000 176 B1.000 176 B4.000 176 A8.000 176 B4.000 178 B5.000 176 B5.000 176 B4.000	60340202 5893660 60340201 5893660 60340203 5893663 5893661	 60340005 7640784 1,80mm ø71,5
1,2 1242	4 CYL ø70,8 PALIO 02/02--> SIENA 02/02--> BRAVA 10/00-->10/01 BRAVO 10/00-->10/01 IDEA 09/99--> PUNTO 09/99--> STILO 09/99-->	80 PS / 59 KW 80 PS / 59 KW 80 PS / 59 KW 80 PS / 59 KW 80 PS / 59 KW 80 PS / 59 KW 80 PS / 59 KW	178 D7.055 178 D7.055 188 A5.000 188 A5.000 188 A5.000 188 A5.000 188 A5.000	62427902 Motor Full Takım Gasket Full Set 62427903 71739160	 62427905 55197283 MLS ø72
1,2 1242	4 CYL ø70,8 PANDA 10/07--> PANDA (169) PUNTO / GRANDE PUNTO PUNTO EVO 500 500 C	69 PS / 51 KW	169 A.4000	62428002 Motor Full Takım Gasket Full Set 62428003 71740655 62428004 71728839	 62428005 55183371 MLS ø72
1,3	4 CYL ø72 125 1961-->1966			63110002 Motor Full Takım Gasket Full Set 63110000	 63110005 1,20mm 63110006 1,80mm ø76

▲ : İçerikte Bulunmamaktadır...

▲ : Not included in the set

▲ : Non inclus dans la pochette

00: Motor Takım Keçesiz ve Subap Lastiksiz











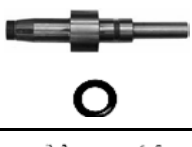
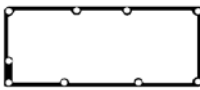











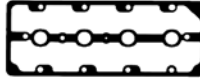
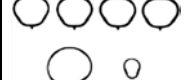

00: Gasket Set Without oil seals Without Valve Stem Seal

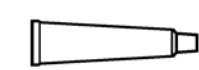
01: Motor Takım Keçesiz - Subap Lastikli

01: Gasket set With Valve Stem Seal Without Oil Seals

02: Motor Full Takım Keçeli ve Subap Lastikli

02: Gasket Full Set With oil seals and Valve Stem Seals

Subap Kapak Valve Cover Gasket Zylinderkopfhaube Couvre-culbut.	Karter Oil Pan Ölwanne Carter d'huile	Emme Manifold Intake Manifold Ansaug Admission	Egzoz Manifold Exhaust Manifold Auspuffkrümmer Collecteur D'echappement	Eksoz Boğaz Exhaust Pipe Auspuff Kehle	Supap Keçesi Valve Stem Seal Ventilschaft Queue de soupape	
						
 60340025 7688450		 60340019 46426046 46754320  60340018 46432735	 60340020x2 7749711	 60340017 46465291	 60116026x8 5930415 7x9,8/13.2x10	21208003 30x42x7 RD 21201072 23x35x7 RD 21204081 74x88x8 LD
 62427925 55194045		 62427918 71729223	 62427921 46526271		 62427426x16 46470334 6x8,8x11,7x9,5	21208048 27x37x7 RD 21208049 40x55x7
 62428025 71740678	 62427465	 62428019 77363787	 62428020 55199355		 62428027x8 55190344 5x7,8/11x8	21208049 40x55x7 21208048 27x37x7 RD 21208050 74x88x8 LD
 60305034 4027732	 60305013 902072	 60305018x2 4086677	 60305020 4072291	 60305017 4061096		21201070 45x62x8 21201071 80x100x10

■ : Delik - Çentik

■ : Hole - Notch

■ : Trou - Entaille

NOT: Katalogdaki Orijinal Kodlar Referans Amacıyla Kullanılmıştır.Lütfen COTECH Kodlarını Kullanınız.
Original codes used for reference only.Please use COTECH codes for orders.

00



01



02



03











04

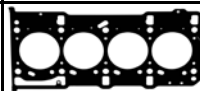

Silindir Kapak
Cylinder Head
Zylinderkopf
Joint de culasse



Ltr	MODEL	PS/KW	ENGINE/MOTOR		
1,3 1242	4 CYL ø69,6 DOBLO 06/03--> DOBLO D DOBLO JTD 16V FIORINO GRANDE PUNTO D GRANDE PUNTO (199) IDEA JTD PALIO PANDA PANDA JTD PUNTO PUNTO EVO PUNTO JTD 16V SIENA 500 500 C DOBLO 10/05--> DOBLO D GRANDE PUNTO D IDEA LINEA PUNTO / GRANDE PUNTO PUNTO EVO STRADA	75 PS / 55 KW 69 PS / 51 KW 90 PS / 66 KW 84 PS / 62 KW	169 A1.000 188 A9.000 199 A2.000 199 A3.000 223 A9.000	62427402 Motor Full Takım Gasket Full Set   62427403 71729499 71744288  62427404 71736913 71744287 	 62427505 55209070 0,72mm 62427506 55209071 0,82mm 1  62427507 55209072 0,92mm 2  MLS ø70,5
1,3 1290	4 CYL ø86,4 128 09/71-->02/76 128 08/74-->12/81 128 12/74-->10/82 128 06/75-->12/79 1,3 RITMO 01/78-->09/82 1301 RITMO 01/81-->09/82 RITMO 1978--> STRADA 01/78-->09/82 STRADA 01/81-->09/82 65 L-CL Pick-Up Todos Tipos Motor All Engine Types Tous Types de Moteur	67 PS / 49 KW 60 PS / 44 KW 73 PS / 54 KW 65 PS / 48 KW 65 PS / 48 KW 75 PS / 55 KW 65 PS / 48 KW 65 PS / 48 KW 75 PS / 55 KW	128 A1. 128 A1. 128 A1.000 128 AC.000 138 A1.000 138 A3.000 128 A5.000 138 A1.000 138 A3.000	60307002 5881127 60307000 5881127	 60307005 4448401 1,20mm 60307006 4420365 5891281 1,80mm ø87,5

▲ : İçerikte Bulunmamaktadır...

▲ : Not included in the set

▲ : Non inclus dans la pochette

00: Motor Takım Keçesiz ve Subap Lastiksiz











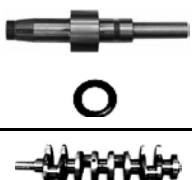
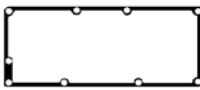

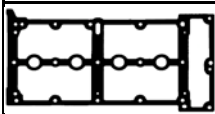
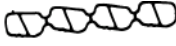

00: Gasket Set Without oil seals Without Valve Stem Seal

01: Motor Takım Keçesiz - Subap Lastikli

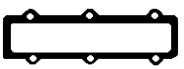
01: Gasket set With Valve Stem Seal Without Oil Seals

02: Motor Full Takım Keçeli ve Subap Lastikli

02: Gasket Full Set With oil seals and Valve Stem Seals

Subap Kapak Valve Cover Gasket Zylinderkopfhaube Couvre-culbut.	Karter Oil Pan Ölwanne Carter d'huile	Emme Manifold Intake Manifold Ansaug Admission	Egzoz Manifold Exhaust Manifold Auspuffkrümmer Collecteur D'echappement	Eksoz Boğaz Exhaust Pipe Auspuff Kehle	Supap Keçesi Valve Stem Seal Ventilschaft Queue de soupape	
						
 62427425 73500063		 62427417 71748757	 62427421 73500058		 62427426x16 46556651 6x8,8x11,7x9,5	21204023 40x52x7 RD 21204034 78X100X9 RD
 60304034 4448677  60304035 7784728	 60306013 4179038	 60306020x2 4309031		 60301018 4147260	 60107027x8 7553637 8x10,8x14,2x10	21201006 30x52x7 RD 21201017 40x56x7 RD 21201030 64x80x8 LD

 : Delik - Çentik

 : Hole - Notch

 : Trou - Entaille

NOT: Katalogdaki Orijinal Kodlar Referans Amacıyla Kullanılmıştır.Lütfen COTECH Kodlarını Kullanınız.
Original codes used for reference only.Please use COTECH codes for orders.

FIAT

00



Silindir Kapak
Cylinder Head

01



Zylinderkopf

02







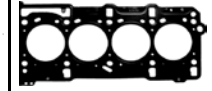

Joint de culasse

03



04

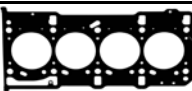

Ltr	MODEL	PS/KW	ENGINE/MOTOR		
1,3 1242	4 CYL ø69,6 DOBLO 10/05--> DOBLO D FIORINO GRANDE PUNTO (199) IDEA PANDA PANDA(312) PUNTO PUNTO EVO PUNTO / GRANDE PUNTO QUBA STRADA 500 500 C 500 L PANDA (312) 07/08--> PUNTO / GRANDE PUNTO(199) PUNTO EVO(199) DOBLO (263) 11/13-->	95 PS / 70 KW 75 PS / 55 KW 80 PS / 59 KW 69 PS / 51 KW 75 PS / 55 KW	169 A5.000 199 A9.000 199 B1.000 199 B4.000 223 A9.000 263 A2.000 199 A1.000 199 B2.000 199 B8.000 312 A8.000 263 A6.000	62427502 Motor Full Takım Gasket Full Set   62427503 71753908  62427504 71753767 	 62427505 55209070 0,72mm 62427506 55209071 0,82mm 1  62427507 55209072 0,92mm 2  MLS ø70,5

▲ : İçerikte Bulunmamaktadır...

▲ : Not included in the set

▲ : Non inclus dans la pochette

00: Motor Takım Keçesiz ve Subap Lastiksiz







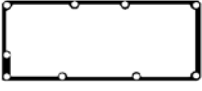
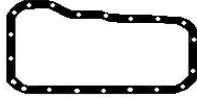

00: Gasket Set Without oil seals Without Valve Stem Seal

01: Motor Takım Keçesiz - Subap Lastikli

01: Gasket set With Valve Stem Seal Without Oil Seals

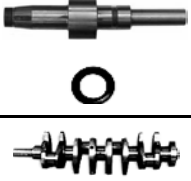
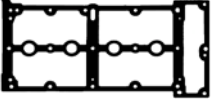
02: Motor Full Takım Keçeli ve Subap Lastikli

02: Gasket Full Set With oil seals and Valve Stem Seals

<p>Subap Kapak Valve Cover Gasket Zylinderkopfhaube Couvre-culbut.</p> 	<p>Karter Oil Pan Ölwanne Carter d'huile</p> 	<p>Emme Manifold Intake Manifold Ansaug Admission</p> 	<p>Egzoz Manifold Exhaust Manifold Auspuffkrümmer Collecteur D'echappement</p> 	<p>Eksoz Boğaz Exhaust Pipe Auspuff Kehle</p> 	<p>Supap Keçesi Valve Stem Seal Ventilschaft Queue de soupape</p> 	
 <p>62427425 73500063</p>		 <p>62427518x4 71749369</p>	 <p>62427421 73500058</p>		 <p>62427426x16 46556651 6x8,8x11,7x9,5</p>	<p>21204023 40x52x7 RD</p> <p>21204034 78X100X9 RD</p>

■ : Delik - Çentik

■ : Hole - Notch

■ : Trou - Entaille

NOT: Katalogdaki Orijinal Kodlar Referans Amacıyla Kullanılmıştır.Lütfen COTECH Kodlarını Kullanınız.
Original codes used for reference only.Please use COTECH codes for orders.

00



01



02



03



04



Silindir Kapak
Cylinder Head
Zylinderkopf
Joint de culasse

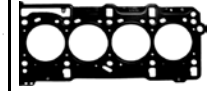

Ltr	MODEL	PS/KW	ENGINE/MOTOR		
1,3 1290	4 CYL ø86,4 128 09/71-->02/76 128 08/74-->12/81 128 12/74-->10/82 128 06/75->12/79 1,3 RITMO 01/78-->09/82 1301 RITMO 01/81-->09/82 RITMO 1978--> STRADA 01/78-->09/82 STRADA 01/81-->09/82 65 L-CL Pick-Up Todos Tipos Motor All Engine Types Tous Types de Moteur	67 PS / 49 KW 60 PS / 44 KW 73 PS / 54 KW 65 PS / 48 KW 65 PS / 48 KW 75 PS / 55 KW 65 PS / 48 KW 65 PS / 48 KW 75 PS / 55 KW	128 A1. 128 A1. 128 A1.000 128 AC.000 138 A1.000 138 A3.000 128 A5.000 138 A1.000 138 A3.000	60307102+ 60307006 60307100+ 60307006	 60307005 4448401 1,20mm 60307006 4420365 5891281 1,80mm ø87,5
1,3 1301	4 CYL ø86,4 REGATA 09/83-->07/89 REGATA 09/83-->07/89 RITMO 09/83-->07/89 RITMO 09/83-->07/89 RITMO 1982-->1986 UNO 05/85-->08/89 UNO 05/85-->08/89 70 S 85 S Automático Automatic S/SX/ELX	65 PS / 48 KW 65 PS / 48 KW 65 PS / 48 KW 65 PS / 48 KW 82 PS / 60 KW 65 PS / 48 KW 65 PS / 48 KW	149 A3.000 149 A7.000 149 A3.000 149 A7.000 138 B2.000 149 A7.000 149 A3.000	62426202 5882782 62426201 5882782	 62426105 7679380 1,80mm ø87
1,3 1297	4 CYL ø76 131 10/74-->12/81 C - L - S Mirafiori	54 PS / 50 KW 55 PS / 40 KW 78 PS / 57 KW	131 A6.000 131 B.000	60302002 5880442 60302001 5880442	 60302005 7387620 1,20mm 60302006 7387620 1,80mm ø78

▲ : İçerikte Bulunmamaktadır...

▲ : Not included in the set

▲ : Non inclus dans la pochette

00: Motor Takım Keçesiz ve Subap Lastiksiz











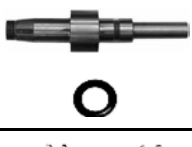
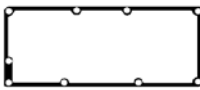





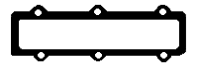



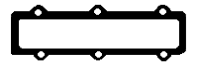

00: Gasket Set Without oil seals Without Valve Stem Seal

01: Motor Takım Keçesiz - Subap Lastikli

01: Gasket set With Valve Stem Seal Without Oil Seals

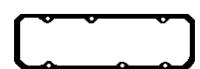
02: Motor Full Takım Keçeli ve Subap Lastikli

02: Gasket Full Set With oil seals and Valve Stem Seals

Subap Kapak Valve Cover Gasket Zylinderkopfhaube Couvre-culbut.	Karter Oil Pan Ölwanne Carter d'huile	Emme Manifold Intake Manifold Ansaug Admission	Egzoz Manifold Exhaust Manifold Auspuffkrümmer Collecteur D'echappement	Eksoz Boğaz Exhaust Pipe Auspuff Kehle	Supap Keçesi Valve Stem Seal Ventilschaft Queue de soupape	
						
 60304034 4448677	 60306013 4179038	 60306020x2 4309031		 60301018 4147260	 60107027x8 7553637 8x10,8x14,2x10	21201006 30x52x7 RD
 60304035 7784728						21201017 40x56x7 RD
						21201030 64x80x8 LD
 60304034 4448677	 60306013 4179038	 60306020x2 4309031		 60301018 4147260	 60107027x8 7553637 8x10,8x14,2x10	21201006 30x52x7 RD
 60304035 7784728						21201017 40x56x7 RD
						21201030 64x80x8 LD
 60301034 4130541	 60303013 4331606	 60302020x2 4336357		 60301018 4147260	 60107027x8 7553637 8x10,8x14,2x10	21201006 30x52x7 RD
						21201017 40x56x7 RD
						21201066 70x90x10 LD

■ : Delik - Çentik

■ : Hole - Notch

■ : Trou - Entaille

NOT: Katalogdaki Orijinal Kodlar Referans Amacıyla Kullanılmıştır.Lütfen COTECH Kodlarını Kullanınız.
Original codes used for reference only.Please use COTECH codes for orders.

00



01



02



03



04



Silindir Kapak
Cylinder Head
Zylinderkopf
Joint de culasse

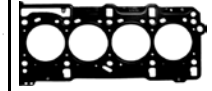

Ltr	MODEL	PS/KW	ENGINE/MOTOR		
1,4 1372	4 CYL ø80,5 TIPO 05/1989-->04/1995 TIPO 07/1987-->12/1989 TIPO 07/1987-->12/1989 TIPO 05/1989-->04/1995 UNO 09/1989-->12/1993 UNO 09/1989-->12/1993 UNO 1989-->1993 TEMPRA 10/89-->05/95 TEMPRA 1990-->1993 TEMPRA 10/92-->08/96 TEMPRA 10/92-->08/96 FIORINO 10/89-->05/95 FIORINO 10/89-->05/95 PALIO 04/96--> PALIO 04/96--> SIENA 04/96--> SIENA 04/96--> Furgoneta i.e. S.W.	69 PS / 51 KW 71 PS / 52 KW 71 PS / 52 KW 78 PS / 57 KW 70 PS / 51 KW 72 PS / 53 KW 72 PS / 53 KW 69 PS / 51 KW 72 PS / 53 KW 69 PS / 51 KW 69 PS / 51 KW 69 PS / 51 KW 67 PS / 49 KW 67 PS / 49 KW 69 PS / 51 KW 69 PS / 51 KW 69 PS / 51 KW 69 PS / 51 KW	836 A4.000 160 A1.048 160 A1.000 160 A1.046 160 A1.046 146 C1.000 146 C1.0000 160 A1.046 159 A2.000 160 A1.046 836 A4.000 146 C5.000 146 D5.000 178 B2.000 178 B2.016 178 B2.000 178 B2.016	60314002 5892410 60314001 5892410 60314003 5888262	 60314005 7666858 1,80mm ø81
1,4 1368	4 CYL ø72 IDEA 01/04-->04/06 STILO 01/04-->04/06 PANDA 10/06--> 500 500 C	90 PS / 66 KW 90 PS / 66 KW 100 PS / 74 KW	192 B2.000 843 A1.000 169 A3.000		 62427905 55197283 MLS ø72
1,4 1368	4 CYL ø72 DOBLO 10/05--> FIORINO GRANDE PUNTO IDEA LINEA PANDA PUNTO / GRANDE PUNTO PUNTO EVO QUBO	78 PS / 57 KW 77 PS / 57 KW	350 A1.000	62428002 Motor Full Takım Gasket Full Set 62428003 71740655 62428004 71728839	 62428005 55183371 MLS ø72

▲ : İçerikte Bulunmamaktadır...

▲ : Not included in the set

▲ : Non inclus dans la pochette

00: Motor Takım Keçesiz ve Subap Lastiksiz











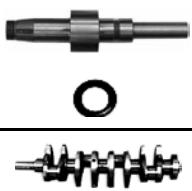
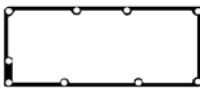

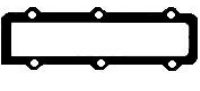

00: Gasket Set Without oil seals Without Valve Stem Seal

01: Motor Takım Keçesiz - Subap Lastikli

01: Gasket set With Valve Stem Seal Without Oil Seals

02: Motor Full Takım Keçeli ve Subap Lastikli

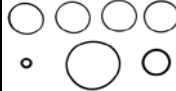
02: Gasket Full Set With oil seals and Valve Stem Seals

Subap Kapak Valve Cover Gasket Zylinderkopfhaube Couvre-culbut.	Karter Oil Pan Ölwanne Carter d'huile	Emme Manifold Intake Manifold Ansaug Admission	Egzoz Manifold Exhaust Manifold Auspuffkrümmer Collecteur D'echappement	Eksoz Boğaz Exhaust Pipe Auspuff Kehle	Supap Keçesi Valve Stem Seal Ventilschaft Queue de soupape	
						
 60304034 7797034	 60304013 7554363 76663366	 60304020 7772495			 60107027x8 7553637 8x10,8/14,2x10	21201006x2 30x52x7 RD
 60304035 7784728						21201017 40x56x7 RD 21201030 64x80x8 LD
 62428025 71740678	 62427465	 62428019 77363787	 62428020 55199355		 62428027x8 55190344 5x7,8/11x8	21208049 40x55x7 21208048 27x37x7 RD 21208050 74x88x8 LD

■ : Delik - Çentik

■ : Hole - Notch

■ : Trou - Entaille

NOT: Katalogdaki Orijinal Kodlar Referans Amacıyla Kullanılmıştır.Lütfen COTECH Kodlarını Kullanınız.
Original codes used for reference only.Please use COTECH codes for orders.

00



Silindir Kapak
Cylinder Head

01



Zylinderkopf

02



Joint de culasse

03



04

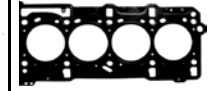

Ltr	MODEL	PS/KW	ENGINE/MOTOR		
1,4 1438	4 CYL ø80 124 01/66-->10/72 124 SPECIAL T 124 SPORT 124 COUPE	90 PS / 66 KW	124 AC.000 124 B2.000	60312002 5880432 60312000 5880432	 60312005 4387612 1,40mm 60312006 4315064 1,80mm ø81
1,4 1367	4 CYL ø78 131 MIRAFIORI 1984--> L / CL			63116002 63116000	 63116005 4434953 1,60mm ø80
1,4 1438	4 CYL ø80 124 12/68-->12/72 124 01/73-->07/75 Special	70 PS / 51 KW 75 PS / 55 KW	124 B2.000 124 B2.000	63115002 5880430 63115000 5880430	 63115005 4387613 1,40mm 63115006 4137856 1,80mm ø81
1,5 1498	4 CYL ø86,4 FIORINO 01/78-->10/82 RITMO 01/78-->10/82 STRADA 01/78-->10/82 75 C-CL Furgoneta Pick-Up S75	75 PS / 55 KW	138 B 18 A4	60307002 5881127 60307000 5881127	 60307005 4448401 1,20mm 60307006 4420365 5891281 1,80mm ø87,5

▲ : İçerikte Bulunmamaktadır...

▲ : Not included in the set

▲ : Non inclus dans la pochette

00: Motor Takım Keçesiz ve Subap Lastiksiz











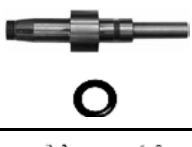
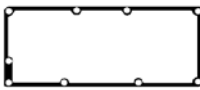







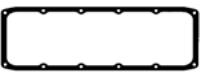

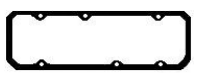

00: Gasket Set Without oil seals Without Valve Stem Seal

01: Motor Takım Keçesiz - Subap Lastikli

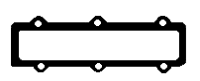
01: Gasket set With Valve Stem Seal Without Oil Seals

02: Motor Full Takım Keçeli ve Subap Lastikli

02: Gasket Full Set With oil seals and Valve Stem Seals

Subap Kapak Valve Cover Gasket Zylinderkopfhaube Couvre-culbut.	Karter Oil Pan Ölwanne Carter d'huile	Emme Manifold Intake Manifold Ansaug Admission	Egzoz Manifold Exhaust Manifold Auspuffkrümmer Collecteur D'echappement	Eksoz Boğaz Exhaust Pipe Auspuff Kehle	Supap Keçesi Valve Stem Seal Ventilschaft Queue de soupape	
						
60308035x2 4388512	60301013 4129756	60308018 4194060	60308020 4177112 7709259	60308017 4166914	60107027x8 7553637 8x10,8/14,2x10	21201006x2 30x52x7 RD
						21201017 40x56x7 RD
60308034x2 4158646						21201066 70x90x10 LD
						21201006 30x52x7 RD
63111035 5996632	60303013 4331606	63111020 4462674		60301018 4147260		21201017 40x56x7 LD
						21201066 70x90x10 RD
						21201017 40x56x7 LD
60301034 4130541	60301013 4129756	60301020x2 4177631		60301018 4147260	60107027x8 7553637 8x10,8x14,2x10	21201066 70x90x10 RD
						21201006x2 30x52x7 RD
60304034 4448677	60306013 4179038	60306020x2 4309031		60301018 4147260	60107027x8 7553637 8x10,8x14,2x10	21201017 40x56x7 RD
						21201030 64x80x8 LD
60304035 7784728						

■ : Delik - Çentik

■ : Hole - Notch

■ : Trou - Entaille

NOT: Katalogdaki Orijinal Kodlar Referans Amacıyla Kullanılmıştır.Lütfen COTECH Kodlarını Kullanınız.
Original codes used for reference only.Please use COTECH codes for orders.

00



Silindir Kapak
Cylinder Head
Zylinderkopf
Joint de culasse

01



02



03



04



Ltr	MODEL	PS/KW	ENGINE/MOTOR		
1,5 1481	4 CYL ø77 1500 L 1500 C	07/62-->03/69 10/63-->12/70	102 PS / 75 KW 72 PS / 53 KW	115 000	60305000 900980 60305005 4056553 1,40mm 60305006 4113043 ø78,5
1,5	4 CYL 125				63112000 63112005 1,20mm 63112006 1,80mm ø81
1,6 1585	4 CYL ø84 131 MIRAFIORI CL 1600	1982-->			63111002 63111000 63111005 5891304 1,70mm ø85
1,6 1581	4 CYL ø86,4 TEMPRA TEMPRA TEMPRA TIPO TIPO TIPO FIORINO FIORINO STRADA SCUDO PALIO Furgoneta i.e. Pick-Up S.W. S/SX/ELX	06/92-->08/96 06/92-->08/96 1990-->1993 1989-->1995 10/92-->04/95 10/92-->04/95 10/93-->12/97 10/93-->12/97 06/99--> 02/96--> 1996-->1997	75 PS / 55 KW 75 PS / 55 KW 84 PS / 62 KW 84 PS / 62 KW 75 PS / 55 KW 75 PS / 55 KW 75 PS / 55 KW 75 PS / 55 KW 75 PS / 55 KW 79 PS / 58 KW 82 PS / 60 KW	159 A3.048 835 C1.000 M202PA.15.0 M202PA.15.0 159 A3.048 835 C1.000 146 C.6000 146 D.6000 1580 MPI 220 A2.000 178 B3.000	60304002 5890649 60304001 60304003 5888319 60304005 46414567 1,80mm ø87

▲ : İçerikte Bulunmamaktadır...

▲ : Not included in the set

▲ : Non inclus dans la pochette

00: Motor Takım Keçesiz ve Subap Lastiksiz











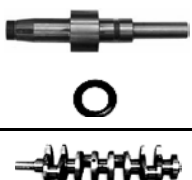
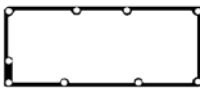





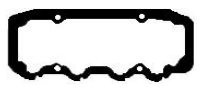



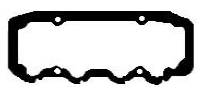

00: Gasket Set Without oil seals Without Valve Stem Seal

01: Motor Takım Keçesiz - Subap Lastikli

01: Gasket set With Valve Stem Seal Without Oil Seals

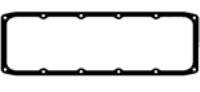
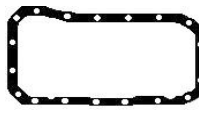
02: Motor Full Takım Keçeli ve Subap Lastikli

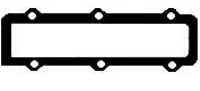
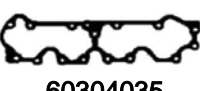
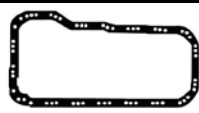
02: Gasket Full Set With oil seals and Valve Stem Seals

Subap Kapak Valve Cover Gasket Zylinderkopfhaube Couvre-culbut.	Karter Oil Pan Ölwanne Carter d'huile	Emme Manifold Intake Manifold Ansaug Admission	Egzoz Manifold Exhaust Manifold Auspuffkrümmer Collecteur D'echappement	Eksoz Boğaz Exhaust Pipe Auspuff Kehle	Supap Keçesi Valve Stem Seal Ventilschaft Queue de soupape	
						
 60305034 4027732	 60305013 902072	 60305016x2 4086669  60305018x2 4086677	  60305020 4072291	 60305017 4061096		
 60305034 4027732	 60305013 902072	 60305016x2 4086669  60305018x2 4086677	  60305020 4072291	 60305017 4061096		
 63111035 5996632	 60303013 4331606	 63111020 4462674		 60301018 4147260		21201006 30x52x7 RD 21201017 40x56x7 LD 21201066 70x90x10 RD
 60304034 7797034  60304035 7784728	 60304013 7554363 7663366	 60304020 7772495			 60107027x8 0956.22 8x10,8/14,2x10	21201006x2 30x52x7 RD 21201017 40x56x7 RD 21201030 64x80x8 LD

■ : Delik - Çentik

■ : Hole - Notch

■ : Trou - Entaille

NOT: Katalogdaki Orijinal Kodlar Referans Amacıyla Kullanılmıştır.Lütfen COTECH Kodlarını Kullanınız.
Original codes used for reference only.Please use COTECH codes for orders.

00



01



02



03



04



Silindir Kapak
Cylinder Head
Zylinderkopf
Joint de culasse

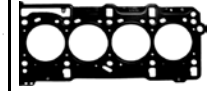

Ltr	MODEL	PS/KW	ENGINE/MOTOR		
1,6	4 CYL ø86,4				
1581	MAREA 09/99-->	103 PS / 76 KW	182 A4.000	62423402	
	MAREA 09/99-->	103 PS / 76 KW	185 A3.000	71713032	
	MAREA 09/99-->	103 PS / 76 KW	182 B5.098	5895664	62423405
	BRAVA 10/95-->10/01	90 PS / 66 KW	182 A6.000		46410960
	BRAVO 09/99-->	90 PS / 66 KW	182 A6.000		1,80mm
	MULTIPLA 04/99-->	103 PS / 76 KW	186 A4.000	62423403	ø87
	MULTIPLA 04/99-->	103 PS / 76 KW	182 A4.000	5895663	
	MULTIPLA 04/99-->	103 PS / 76 KW	186 A3.000	71713031	
	MULTIPLA 04/96-->	103 PS / 76 KW	186 A4.000		
	MULTIPLA 04/99-->	95 PS / 70 KW	186 A3.000		
	PALIO 04/96-->	100 PS / 74 KW	178 B3.000		
	PALIO 04/96-->	95 PS / 67 KW	182 A4.000		
	PALIO 04/96-->	103 PS / 76 KW	182 A6.000		
	SCUDO 1995-->	103 PS / 76 KW	182		
	SIENA 09/98-->	92 PS / 68 KW	178 D2.011		
	SIENA	103 PS / 76 KW	178 C7.098		
	16 V				
1,6	4 CYL ø84				
1585	131 MIRAFIORI 10/74-->09/81	75 PS / 55 KW	131 A1.000	60303002	
	242/15 10/75-->07/82	63 PS / 46 KW	124 B3.000	5880444	
	C-L-S			5880442	60303005
					5891273
				60303000	1,60mm
				5880444	ø85
				5880442	
1,6	4 CYL ø84				
1585	131 03/1973-->03/1982	98 PS / 72 KW	131 B1.000	60309002	
	131 01/1978-->06/1985	85 PS / 63 KW	131 C2.000	5880452	
	131 01/1978-->06/1985	97 PS / 71 KW	131 C3.000		60309005
	132 01/1976-->12/1982	98 PS / 72 KW	132 C.000		4387624
	132 03/1977-->12/1981	90 PS / 66 KW	132 C6.000		1,40mm
	Argento 04/1981-->12/1985	98 PS / 72 KW	132 D.000	60309000	
	Argento 04/1981-->12/1985	90 PS / 66 KW	132 A	5880452	60309006
	Ritmo 05/1981-->12/1982	105 PS / 77 KW	138 AR.000		5951675
	Berlina				1,80mm
	131 -->1982	98 PS / 72 KW	TC		ø85
	132 01/78-->05/82	118 PS / 86 KW	2ACT		
	REGATA 100				
	RITMO STRADA				
	131 SUPERMIRAFIORI				
	Sport				
	Super				

▲ : İçerikte Bulunmamaktadır...

▲ : Not included in the set

▲ : Non inclus dans la pochette

00: Motor Takım Keçesiz ve Subap Lastiksiz











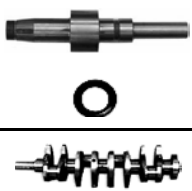
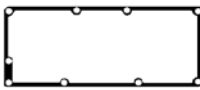







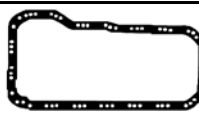





00: Gasket Set Without oil seals Without Valve Stem Seal

01: Motor Takım Keçesiz - Subap Lastikli

01: Gasket set With Valve Stem Seal Without Oil Seals

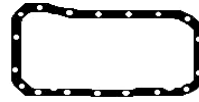
02: Motor Full Takım Keçeli ve Subap Lastikli

02: Gasket Full Set With oil seals and Valve Stem Seals

Subap Kapak Valve Cover Gasket Zylinderkopfhaube Couvre-culbut.	Karter Oil Pan Ölwanne Carter d'huile	Emme Manifold Intake Manifold Ansaug Admission	Egzoz Manifold Exhaust Manifold Auspuffkrümmer Collecteur D'echappement	Eksoz Boğaz Exhaust Pipe Auspuff Kehle	Supap Keçesi Valve Stem Seal Ventilschaft Queue de soupape	
						
 62423434x2 7773831 46467203	 60304013 7554363 7663366	 62423419 46410505  62423415x4 46402220	 62423420 46412116		 62423427x16 7581344 7x9.8x13,2x10	21201006x2 30x52x7 RD 21201017 40x56x7 RD 21201030 64x80x8 LD
 60301034 4130541	 60303013 4331606	 60302020x2 4336357		 60301018 4147260	 60107027x8 7553637 8x10,8/14,2x10	21201006 30x52x7 RD 21201017 40x56x7 LD 21201066 70x90x10 RD
 60308035x2 4388512  60308034x2 4158646	 60303013 4331606	 60308018 4194060	 60308020 4177112 7709259	 60308017 4166914	 60107027x8 7553637 8x10,8/14,2x10	21201006x2 30x52x7 RD 21201017 40x56x7 RD 21201066 70x90x10 LD

■ : Delik - Çentik

■ : Hole - Notch

■ : Trou - Entaille

NOT: Katalogdaki Orijinal Kodlar Referans Amacıyla Kullanılmıştır.Lütfen COTECH Kodlarını Kullanınız.
Original codes used for reference only.Please use COTECH codes for orders.

00



01



02



03



04



Silindir Kapak
Cylinder Head
Zylinderkopf
Joint de culasse

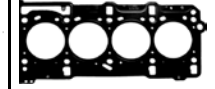

Ltr	MODEL	PS/KW	ENGINE/MOTOR		
1,6 1585	4 CYL ø84 REGATA 12/87-->12/90 REGATA 01/87-->12/90 RITMO 02/88-->05/91 TIPO 02/88-->05/91	99 PS / 73 KW 99 PS / 73 KW 90 PS / 66 KW 90 PS / 66 KW	2 ACT M402AA.16.0 M402AA.16.0 149 C2.046		
					 60330005 4314165 7604264 1,80mm ø85
1,6 1592	4 CYL ø80 124 01/69-->12/75 124 01/69-->12/75 124 01/73-->07/75 124 11/69-->08/73 131 -->1976 132 -->1976 Special T Spider Sport Coupe	108 PS / 80 KW 104 PS / 76 KW 95 PS / 70 KW 100 PS / 74 KW 98 PS / 72 KW 98 PS / 72 KW	132 AC.000 132 AC.000 132AC 132 AC.000 828 828	60308002 5880448 60308000 5880448	 60308005 4263871 1,20mm 60308006 4263871 1,80mm ø82
1,6 1596	4 CYL ø80 MAREA 09/00-->08/02 PALIO 02/01--> ALBEA 11/00--> STILO 10/01-->08/08	103 PS / 76 KW 103 PS / 76 KW 103 PS / 76 KW 103 PS / 76 KW	182 B6.000 182 B6.000 182 B6.000 182 B6.000		 61506005 55187650 46752127 1,80mm ø81
1,6 1598	4 CYL ø79,5 DOBLO 02/10--> LINEA 06/09--> IDEA 05/08--> IDEA 05/08--> BRAVO 09/08--> JTD 16 V	101 PS / 74 KW 105 PS / 77 KW 120 PS / 88 KW 120 PS / 88 KW 105 PS / 77 KW	263 A3.000 198 A3.000 198 A3.000 350 A2.000 198 A3.000 198 A1.000 198 A2.000	62427602 Motor Full Takım Gasket Full Set 62427603 71769851 62427604 71749743	 62427605 55221093 0,82mm 62427606 55221094 0,92mm 1 62427607 55221095 1,02mm 2 MLS ø80,5

▲ : İçerikte Bulunmamaktadır...

▲ : Not included in the set

▲ : Non inclus dans la pochette

00: Motor Takım Keçesiz ve Subap Lastiksiz











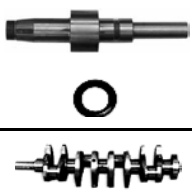
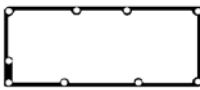







00: Gasket Set Without oil seals Without Valve Stem Seal

01: Motor Takım Keçesiz - Subap Lastikli

01: Gasket set With Valve Stem Seal Without Oil Seals

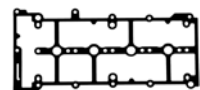
02: Motor Full Takım Keçeli ve Subap Lastikli

02: Gasket Full Set With oil seals and Valve Stem Seals

Subap Kapak Valve Cover Gasket Zylinderkopfhaube Couvre-culbut.	Karter Oil Pan Ölwanne Carter d'huile	Emme Manifold Intake Manifold Ansaug Admission	Egzoz Manifold Exhaust Manifold Auspuffkrümmer Collecteur D'echappement	Eksoz Boğaz Exhaust Pipe Auspuff Kehle	Supap Keçesi Valve Stem Seal Ventilschaft Queue de soupape	
						
						21201006x2 30x52x7 RD
60308035x2 4388512	60301013 4129756	60308018 4194060	60308020 4177112 7709259	60308017 4166914	60107027x8 7553637 8x10,8/14,2x10	21201017 40x56x7 RD
						21201066 70x90x10 LD
60308034x2 4158646						
						21201100 31x41x7 RD
62427625 55205111		62427618 71754211	62427621 55210879		62427626x16 55183812 5x10x23,4x15,5	21201101 30x45x7 RD
						
		62427619 46816020				

■ : Delik - Çentik

■ : Hole - Notch

■ : Trou - Entaille

NOT: Katalogdaki Orijinal Kodlar Referans Amacıyla Kullanılmıştır.Lütfen COTECH Kodlarını Kullanınız.
Original codes used for reference only.Please use COTECH codes for orders.

FIAT

00



01



02



03











04



Silindir Kapak
Cylinder Head
Zylinderkopf
Joint de culasse



Ltr	MODEL	PS/KW	ENGINE/MOTOR		
1,6 1598	4 CYL ø75 SCUDO JTD 16 V 01/07-->	90 PS / 66 KW	9HU	61707002 Motor Full Takım Gasket Full Set 	 61707005 0209.CG 1,45mm 5  61707006 0209.CF 1,40mm 4  61707007 0209.CC 1,30mm 3  61707008 0209.CA 1,25mm 2  61707009 0209.CE 1,35mm 1  MLS ø76
1,6 1608	4 CYL ø80 124 06/67-->10/72 124 06/67-->10/72 124 06/67-->10/72 124 06/67-->10/72 125 06/68-->12/72 Special Sport Coupe Speyder	90 PS / 66 KW 90 PS / 66 KW 90 PS / 66 KW 90 PS / 66 KW 100 PS / 74 KW	124 AC.000 125A 125B 125C 125C	60312002 5880432 60312000 5880432	 60312005 4387612 1,40mm 60312006 4315064 1,80mm ø81

▲ : İçerikte Bulunmamaktadır...

▲ : Not included in the set

▲ : Non inclus dans la pochette

00: Motor Takım Keçesiz ve Subap Lastiksiz











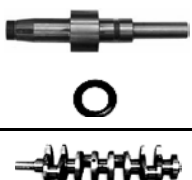
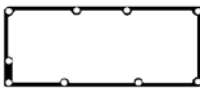





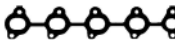

00: Gasket Set Without oil seals Without Valve Stem Seal

01: Motor Takım Keçesiz - Subap Lastikli

01: Gasket set With Valve Stem Seal Without Oil Seals

02: Motor Full Takım Keçeli ve Subap Lastikli

02: Gasket Full Set With oil seals and Valve Stem Seals

Subap Kapak Valve Cover Gasket Zylinderkopfhaube Couvre-culbut.	Karter Oil Pan Ölwanne Carter d'huile	Emme Manifold Intake Manifold Ansaug Admission	Egzoz Manifold Exhaust Manifold Auspuffkrümmer Collecteur D'echappement	Eksoz Boğaz Exhaust Pipe Auspuff Kehle	Supap Keçesi Valve Stem Seal Ventilschaft Queue de soupape	
						
 61707025 0249.C2	 62427465	 0348.R5 x4  0348.R4 x4 61707018 0348.R5+0348.R4 SET	 61706021 0349.J8 0349.J7 0349.N0 1 148 115		 61707026x16 0956.51 5,5x9,5x18,1x14	21204017 27x47x7 RD 21204018 40x55x6,4 LD 21204019 85x105x8,8 RD
 60308035x2 4388512  60308034x2 4158646	 60301013 4129756	 60308018 4194060	 60308020 4177112 7709259	 60308017 4166914	 60107027x8 7553637 8x10,8/14,2x10	21201006x2 30x52x7 RD 21201017 40x56x7 RD 21201066 70x90x10 LD

 : Delik - Çentik

 : Hole - Notch

 : Trou - Entaille

NOT: Katalogdaki Orijinal Kodlar Referans Amacıyla Kullanılmıştır.Lütfen COTECH Kodlarını Kullanınız.
Original codes used for reference only.Please use COTECH codes for orders.

00



01



02



03





04

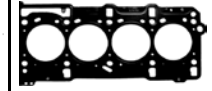

Silindir Kapak
Cylinder Head
Zylinderkopf
Joint de culasse

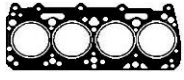

Ltr	MODEL	PS/KW	ENGINE/MOTOR		
1,7 1697	4 CYL ø82,6 REGATA 05/85-->03/89 RITMO 05/85-->12/87 RITMO 05/85-->12/87 TIPO 07/86-->08/89 UNO 07/80-->08/89 DUNA 01/87-->12/91 FIORINO 05/85-->03/89	60 PS / 44 KW 60 PS / 44 KW 60 PS / 44 KW 60 PS / 44 KW 60 PS / 44 KW 60 PS / 44 KW 60 PS / 44 KW	149 B3.000 149 B3.000 138 C.000 149 B3.000 149 B3.000 149 B3.000 149 B3.000	62423502 5882358  62423602 5882358+5962713	 62423505 5962713 1,95mm 2 M 62423506 5962712 1,80mm 1 M 62423507 5962711 1,65mm ø83
1,7 1697	4 CYL ø82,6 FIORINO 11/96-->05/01 FIORINO TD PALIO 01/94--> PALIO TD PUNTO TD SIENA STRADA TD PUNTO D 04/94-->02/00 STILO UNO Diesel Pick-Up Turbo Diesel	63 PS / 46 KW 57 PS / 42 KW 72 PS / 53 KW 69 PS / 51 KW 57 PS / 42 KW	146 D7.000 149 B4.046 176 A3.000 176 A5.000 176 B3.000 178 C9.000	 62426605 46431642 1,95mm 2 M 62426606 46431640 1,80mm 1 M 62426607 7630180 1,65mm FIBER / FIBRE ø83,5	
1,8 1756	4 CYL ø84 TEMPRA 03/92-->08/96 TIPO 10/90-->06/93 TIPO 10/90-->06/93 TIPO 03/93-->04/95 TEMPRA 08/93-->04/96 TIPO 03/93-->04/95 TIPO 03/93-->04/95 TEMPRA 08/93-->04/96	105 PS / 77 KW 105 PS / 77 KW 105 PS / 77 KW 90 PS / 60 KW 90 PS / 60 KW 97 PS / 71 KW 90 PS / 60 KW 97 PS / 71 KW	159 A4.046 159 A4.046 159 A4.000 836 C4.000 835 C4.000 836 A5.000 836 A6.000 836 A5.000	62424001 5893330  62424005 7660966 1,80mm ø85	

▲ : İçerikte Bulunmamaktadır...

▲ : Not included in the set

▲ : Non inclus dans la pochette

00: Motor Takım Keçesiz ve Subap Lastiksiz











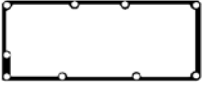
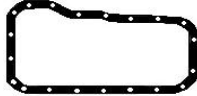

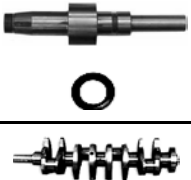
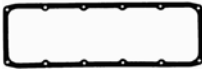

00: Gasket Set Without oil seals Without Valve Stem Seal

01: Motor Takım Keçesiz - Subap Lastikli

01: Gasket set With Valve Stem Seal Without Oil Seals

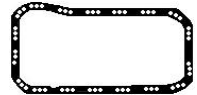
02: Motor Full Takım Keçeli ve Subap Lastikli

02: Gasket Full Set With oil seals and Valve Stem Seals

<p>Subap Kapak Valve Cover Gasket Zylinderkopfhaube Couvre-culbut.</p> 	<p>Karter Oil Pan Ölwanne Carter d'huile</p> 	<p>Emme Manifold Intake Manifold Ansaug Admission</p> 	<p>Egzoz Manifold Exhaust Manifold Auspuffkrümmer Collecteur D'echappement</p> 	<p>Eksoz Boğaz Exhaust Pipe Auspuff Kehle</p> 	<p>Supap Keçesi Valve Stem Seal Ventilschaft Queue de soupape</p> 	
 <p>63111035 4394109 7702774</p>	 <p>62423513 7647596 7647596</p>	 <p>62423520 4436580 7765454</p>			 <p>60107027x8 7553637 8x10,8/14,2x10</p>	<p>21201006 30x52x7 RD</p>
						<p>21208056 30x43x8 RD</p>
						<p>21201066 70x90x10 LD</p>
 <p>60330034x2 7660565</p>  <p>60331035x2 7684064</p>	 <p>62424013 7646248</p>	 <p>60330019 7700197</p>	 <p>60308020 4368925</p>		 <p>60107027x8 7553637 8x10,8/14,2x10</p>	

■ : Delik - Çentik

■ : Hole - Notch

■ : Trou - Entaille

NOT: Katalogdaki Orijinal Kodlar Referans Amacıyla Kullanılmıştır.Lütfen COTECH Kodlarını Kullanınız.
Original codes used for reference only.Please use COTECH codes for orders.

00



01



02



03



04



Silindir Kapak
Cylinder Head
Zylinderkopf
Joint de culasse

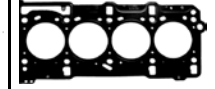

Ltr	MODEL	PS/KW	ENGINE/MOTOR		
1,8 1762	4 CYL ø83 ULYSSE 05/97-->08/02 ULYSSE 05/97-->08/02	99 PS / 73 KW 99 PS / 73 KW	LFW XU7J	61233002 0197.G4+0209.E1	 61207005 0209.E1 1,30mm 1 61207006 0209.L8 1,50mm 2 ø84,5
1,8 1796	4 CYL ø84 DUCATO 01/86-->10/88	67 PS / 49 KW	169 B 280/A14 280.A14.169B	61210001 0197.L1 0197.15	 61210005 0209.F8 ø86,7
1,8 1756	4 CYL ø84 124 01/73-->05/82 132 01/78-->05/82	114 PS / 84 KW 60 PS / 44 KW	132 A7.000 2ACT	60309002 5880452 60309000 5880452	 60309005 4387624 1,40mm 60309006 5951675 1,80mm ø85
1,9 1905	4 CYL ø83 DUCATO 04/98-->04/02 DUCATO 04/98-->04/02 SCUDO 04/98-->04/02 SCUDO 02/96-->	69 PS / 51 KW 69 PS / 51 KW 69 PS / 51 KW 69 PS / 51 KW	DJY D9B DHX(XUD9TF/L) D9B	61204002 95602514 61204003 95602513 	 61204009 0209.S5 1,36 mm 1 61204008 0209.S6 1,40 mm 2 61204007 0209.S7 1,44 mm 3 61204006 0209.S8 1,48 mm 4 61204005 0209.S9 1,53 mm 5 ø 84

▲ : İçerikte Bulunmamaktadır...

▲ : Not included in the set

▲ : Non inclus dans la pochette

00: Motor Takım Keçesiz ve Subap Lastiksiz











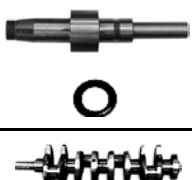
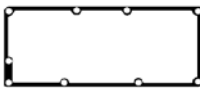





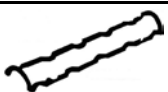



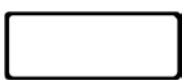







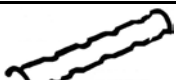

00: Gasket Set Without oil seals Without Valve Stem Seal

01: Motor Takım Keçesiz - Subap Lastikli

01: Gasket set With Valve Stem Seal Without Oil Seals

02: Motor Full Takım Keçeli ve Subap Lastikli

02: Gasket Full Set With oil seals and Valve Stem Seals

Subap Kapak Valve Cover Gasket Zylinderkopfhaube Couvre-culbut.	Karter Oil Pan Ölwanne Carter d'huile	Emme Manifold Intake Manifold Ansaug Admission	Egzoz Manifold Exhaust Manifold Auspuffkrümmer Collecteur D'echappement	Eksoz Boğaz Exhaust Pipe Auspuff Kehle	Supap Keçesi Valve Stem Seal Ventilschaft Queue de soupape	
						
 61233025 0249.71	 61203013 0304.34 93502226.	 61233018x4 0348.E6 + 0348F6	 61233020x4 1723.63		 60107027x8 0956.22 8x10,8/14,2x10	21201062 36x50x7 RD
 61210525 0249.14	 61210013 0304.44	 61211016 0348.33	 61210020 0349.03		 60107027x8 0956.22 8x10,8/14,2x10	
 60308035x2 4388512	 60303013 4331606	 60308018 4194060	 60308020 4177112 7709259	 60308017 4166914	 60107027x8 7553637 8x10,8/14,2x10	21201006x2 30x52x7 RD
 60308034x2 4158646						21201017 40x56x7 RD
 61203525 9350144480 0249.91	 61203013 96042653	 61203116x2 0348.99	 61205019 1721.01 7810024000		 60107027x8 7553637 8x10,8/14,2x10	21201011x2 35x50x8 WD
	 61203014 93501565	 61203018x2 91508659	 61203120x2 0349.47 93010402			21201019 42x62x8 RD
		 61203021 0348.JO				21201040 90x110x7 LD

■ : Delik - Çentik

■ : Hole - Notch

■ : Trou - Entaille

NOT: Katalogdaki Orijinal Kodlar Referans Amacıyla Kullanılmıştır.Lütfen COTECH Kodlarını Kullanınız.
Original codes used for reference only.Please use COTECH codes for orders.

00



01



02



03







04

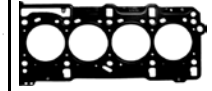

Silindir Kapak
Cylinder Head
Zylinderkopf
Joint de culasse

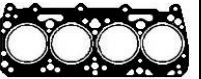
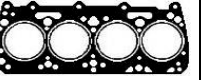

Ltr	MODEL	PS/KW	ENGINE/MOTOR		
1,9 1910	4 CYL ø82 BRAVA JTD 09/96--> BRAVO JTD DOBLO JTD MAREA TD PALIO PUNTO JTD STRADA JTD BRAVO 01/01--> DOBLO DOBLO D DOBLO JTD IDEA JTD MAREA JTD MULTIPLA MULTIPLA JTD PUNTO JTD STILO STILO D STILO JTD PUNTO JTD 02/00--> DOBLO JTD 10/01-->	100 PS / 74 KW 80 PS / 59 KW 120 PS / 88 KW 80 PS / 59 KW 86 PS / 63 KW 105 PS / 77 KW 100 PS / 74 KW	182 B9.000 188 A2.000 186 A6.000 186 A8.000 186 A9.000 188 B2.000 192 A1.000 192 A3.000 192 A8.000 192 A9.000 192 B5.000 223 A7.000 937 A7.000 188 A7.000 223 B1.000 223 B2.000	62427802 71718123 71716050  62427803 71716051  62427704 71730213	 62427805 46749904 0,82mm ø83 62427806 46749905 0,92mm 1 ø83 62427807 46749906 1,02mm 2 MLS ø83
1,9 1929	4 CYL ø82,6 REGATA 04/84-->07/89 REGATA 04/84-->07/89 DUCATO 01/88-->08/90 MARENGO 1987-->1989 TALENTO 03/89-->03/94 TEMPRA 1990--> DUNA UNO Diesel Furgoneta S/SX/ELX Turbo Diesel	65 PS / 48 KW 65 PS / 48 KW 71 PS / 52 KW 70 PS / 51 KW 71 PS / 52 KW	149 A1.000 M705BA.19.0 149 B1.000 149 B1.000 149 B1.000 149 A1.000	62423502 5882358  62423602 5882358+5962713	 62423505 5962713 1,95mm 2 62423506 5962712 1,80mm 1 62423507 5962711 1,65mm ø83
1,9 1929	4 CYL ø82,6 REGATA TD 06/86-->07/89 REGATA TD 1986-->1990 RITMO TD STRADA TD	80 PS / 59 KW 80 PS / 59 KW	831 D1.000 M707AT.19.0		 62423505 5962713 1,95mm 2 62423506 5962712 1,80mm 1 62423507 5962711 1,65mm ø83

▲ : İçerikte Bulunmamaktadır...

▲ : Not included in the set

▲ : Non inclus dans la pochette

00: Motor Takım Keçesiz ve Subap Lastiksiz











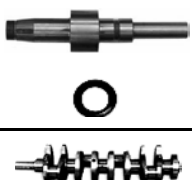
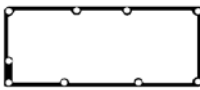





00: Gasket Set Without oil seals Without Valve Stem Seal

01: Motor Takım Keçesiz - Subap Lastikli

01: Gasket set With Valve Stem Seal Without Oil Seals

02: Motor Full Takım Keçeli ve Subap Lastikli

02: Gasket Full Set With oil seals and Valve Stem Seals

Subap Kapak Valve Cover Gasket Zylinderkopfhaube Couvre-culbut.	Karter Oil Pan Ölwanne Carter d'huile	Emme Manifold Intake Manifold Ansaug Admission	Egzoz Manifold Exhaust Manifold Auspuffkrümmer Collecteur D'echappement	Eksoz Boğaz Exhaust Pipe Auspuff Kehle	Supap Keçesi Valve Stem Seal Ventilschaft Queue de soupape	
						
 62427825 46552748		 62427820 71738458	 62427721 46467747		 60107027x8 60504110 8x10,8/14,2x10	21208003 30x42x7 RD
 62427826 55197598						21201100 31x41x7 RD
 63111035 4394109 7702774	 62423513 7647596 7647596	 62423520 4436580 7765454			 60107027x8 7553637 8x10,8/14,2x10	21201006 30x52x7 RD
						21208056 30x43x8 RD
						21201066 70x90x10 LD

■ : Delik - Çentik

■ : Hole - Notch

■ : Trou - Entaille

NOT: Katalogdaki Orijinal Kodlar Referans Amacıyla Kullanılmıştır.Lütfen COTECH Kodlarını Kullanınız.
Original codes used for reference only.Please use COTECH codes for orders.

FIAT

00



01



02



03









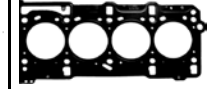





04



Silindir Kapak
Cylinder Head
Zylinderkopf
Joint de culasse



Ltr	MODEL	PS/KW	ENGINE/MOTOR		
1,9 1868	4 CYL ø82,2 SCUDO 04/98-->	69 PS / 51 KW	WJY (DW8B) WJY (DW8)	62173002 0197.X6 	 62173005 0209.1C 1,47mm 62173006 0209.X4 1,42mm 5  62173007 0209.X3 1,38mm 4  62173008 0209.X2 1,34mm 3  62173009 0209.X1 1,30mm 2  62173010 0209.X0 1,26mm 1  MLS ø84
1,9 1910	4 CYL ø82 DOBLO D PALIO PALIO D PUNTO D PUNTO DS SIENA STRADA D 09/99-->	63 PS / 46 KW 60 PS / 45 KW	188 A3.000 223 A6.000	62427702 71715698  62427703 71715699  62427704 71730213	 62427705 46529117 0,82mm 62427706 46529118 0,92mm 1  62427707 46529119 1,02mm 2  MLS ø83

▲ : İçerikte Bulunmamaktadır...

▲ : Not included in the set

▲ : Non inclus dans la pochette

00: Motor Takım Keçesiz ve Subap Lastiksiz











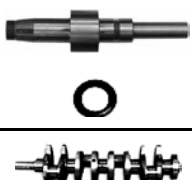
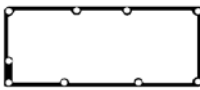

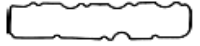

00: Gasket Set Without oil seals Without Valve Stem Seal

01: Motor Takım Keçesiz - Subap Lastikli

01: Gasket set With Valve Stem Seal Without Oil Seals

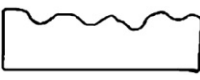
02: Motor Full Takım Keçeli ve Subap Lastikli

02: Gasket Full Set With oil seals and Valve Stem Seals

Subap Kapak Valve Cover Gasket Zylinderkopfhaube Couvre-culbut.	Karter Oil Pan Ölwanne Carter d'huile	Emme Manifold Intake Manifold Ansaug Admission	Egzoz Manifold Exhaust Manifold Auspuffkrümmer Collecteur D'echappement	Eksoz Boğaz Exhaust Pipe Auspuff Kehle	Supap Keçesi Valve Stem Seal Ventilschaft Queue de soupape	
						
 62173025 0249.95	 61203013 96042653	 62173018x2 0348.N2	 62173021x2 0349.H7		 60107027x8 7553637 8x10,8/14,2x10	21208023 35x50x8 RD 21201019 42x62x8 RD 21201040 90x110x10 LD
 62427725 46552748		 46548450x4  46548459x4 62427719x8	 62427721 46467747		 60107027x8 7553637 8x10,8/14,2x10	21201005 30x42x7 RD 21201100 31x41x7 RD

■ : Delik - Çentik

■ : Hole - Notch

■ : Trou - Entaille

NOT: Katalogdaki Orijinal Kodlar Referans Amacıyla Kullanılmıştır.Lütfen COTECH Kodlarını Kullanınız.
Original codes used for reference only.Please use COTECH codes for orders.

00



01



02



03



04



Silindir Kapak
Cylinder Head
Zylinderkopf
Joint de culasse

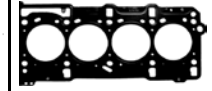

Ltr	MODEL	PS/KW	ENGINE/MOTOR			
1,9 1929	4 CYL ø82,6 BRAVA 10/95-->10/01 BRAVO 10/95-->10/01 DUCATO TD 06/90-->04/95 DUCATO TD 03/89-->03/94 TEMPRA TD 05/1990-->08/1996 TEMPRA TD 07/91-->08/96 TIPO TD 09/90-->04/95 DUCATO TD 04/93-->	65 PS / 48 KW 65 PS / 48 KW 90 PS / 66 KW 82 PS / 60 KW 90 PS / 66 KW 65 PS / 48 KW 90 PS / 66 KW 82 PS / 60 KW	160 A7.000 160 A7.000 280 A1.000 280 A1.000 160 A6.000 160 A7.000 160 D1.000 160 A6.000 160 A7.000 160 B.0646 160 A.0646 230 A3.000 230 A4.000			<p>62426605 46431642 1,95mm 2 ▲ 62426606 46431640 1,80mm 1 ▲ 62426607 7630180 1,65mm FIBER / FIBRE ø83,5</p>
2,0 1971	4 CYL ø88 DUCATO 1981--> TALENTO 10/81-->02/89	75 PS / 55 KW 75 PS / 55 KW	280/B25/170B 170 C 170 D XM1T 170 B	61211001 9400197139	<p>61211005 0209.46 1,20mm 61211006 0209.46 1,80mm ø90</p>	
2,0 1995	4 CYL ø84 131 06/78-->01/82 131 06/78-->01/82 132 07/77-->06/81 ARGENTA 05/78-->07/82	115 PS / 85 KW 115 PS / 85 KW 112 PS / 82 KW 113 PS / 83 KW	131 B2.000 131 B2.000(TC) 132 C2.000 2000	60309002 5880452 60309000 5880452	<p>60309005 4387624 1,40mm 60309006 5951675 1,80mm ø85</p>	
2,0 1995	4 CYL ø84 TIPO 06/90-->03/92 TEMPRA 10/90-->08/96 CROMA 03/87-->09/92	109 PS / 80 KW 113 PS / 83 KW 120 PS / 8 KW	159 A5.046 159 A6.046 154 C3.000	62424001 5893330	<p>62424005 7660966 1,80mm ø85</p>	

▲ : İçerikte Bulunmamaktadır...

▲ : Not included in the set

▲ : Non inclus dans la pochette

00: Motor Takım Keçesiz ve Subap Lastiksiz











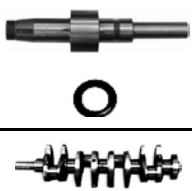
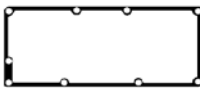





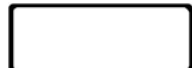









00: Gasket Set Without oil seals Without Valve Stem Seal

01: Motor Takım Keçesiz - Subap Lastikli

01: Gasket set With Valve Stem Seal Without Oil Seals

02: Motor Full Takım Keçeli ve Subap Lastikli

02: Gasket Full Set With oil seals and Valve Stem Seals

Subap Kapak Valve Cover Gasket Zylinderkopfhaube Couvre-culbut.	Karter Oil Pan Ölwanne Carter d'huile	Emme Manifold Intake Manifold Ansaug Admission	Egzoz Manifold Exhaust Manifold Auspuffkrümmer Collecteur D'echappement	Eksoz Boğaz Exhaust Pipe Auspuff Kehle	Supap Keçesi Valve Stem Seal Ventilschaft Queue de soupape	
						
 61210525 7910009723	 61210013 0322.10 0304.11	 61211016 7910018516  61211015 0348.21	 61210020 7910009720	 61205017 1710.09  61212019 1710.19	 60107027x8 7553637 8x10,8/14,2x10	
 60308035x2 4388512  60308034x2 4158646	 60303013 4331606	 60308018 4194060	 60308020 4177112 7709259	 60308017 4166914	 60107027x8 7553637 8x10,8/14,2x10	21201006x2 30x52x7 RD 21201017 40x56x7 RD 21201066 70x90x10 LD
 60330034x2 7660565  60331035x2 7684064	 62424013 7646248	 60330019 7700197	 60308020 4368925		 60107027x8 7553637 8x10,8/14,2x10	

■ : Delik - Çentik

■ : Hole - Notch

■ : Trou - Entaille

NOT: Katalogdaki Orijinal Kodlar Referans Amacıyla Kullanılmıştır.Lütfen COTECH Kodlarını Kullanınız.
Original codes used for reference only.Please use COTECH codes for orders.

00



01



02



03



04



Silindir Kapak
Cylinder Head
Zylinderkopf
Joint de culasse

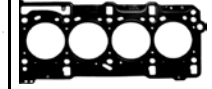

Ltr	MODEL	PS/KW	ENGINE/MOTOR		
2,5 2500	4 CYL ø93 DUCATO 01/82-->12/86	75 PS / 55 KW	U25/651	61215003 0197.K1	 61215005 0209.L5 1,40mm ø95,5
2,5 2500	4 CYL ø93 DUCATO 09/86-->05/94 DUCATO TD 03/94--> DUCATO DUCATO TDI	95 PS / 70 KW 116 PS / 85 KW 109 PS / 80 KW	8140.27 8140.47 8140.47R 8140.47R.2210 8140.47.3700 8142.27S/28		 60138005 98448817 1,50mm 60138006 99461499 1,40mm ø95
2,5 2500	4 CYL ø93 DUCATO D 03/94-->04/02 CROMA D 01/82-->03/94 DUCATO D	84 PS / 62 KW 75 PS / 55 KW	8140.67 8144.67 8144.67.220		 60147005 98498291 1,80mm 60147006 98492581 1,70mm ø95,2
2,8 2799	4 CYL ø94,4 DUCATO 01/96--> DUCATO TDI	122 PS / 90 KW	8140.23 8140.43	60139000 99477116	 60139005 99458402 1,50mm 60139006 99460983 1,40mm 60139007 99432353 1,30mm ø96

▲ : İçerikte Bulunmamaktadır...

▲ : Not included in the set

▲ : Non inclus dans la pochette

00: Motor Takım Keçesiz ve Subap Lastiksiz











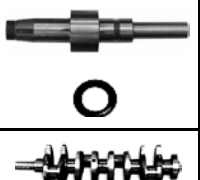
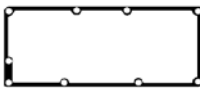



00: Gasket Set Without oil seals Without Valve Stem Seal

01: Motor Takım Keçesiz - Subap Lastikli

01: Gasket set With Valve Stem Seal Without Oil Seals

02: Motor Full Takım Keçeli ve Subap Lastikli

02: Gasket Full Set With oil seals and Valve Stem Seals

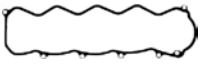
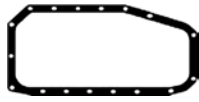
Subap Kapak Valve Cover Gasket Zylinderkopfhaube Couvre-culbut.	Karter Oil Pan Ölwanne Carter d'huile	Emme Manifold Intake Manifold Ansaug Admission	Egzoz Manifold Exhaust Manifold Auspuffkrümmer Collecteur D'echappement	Eksoz Boğaz Exhaust Pipe Auspuff Kehle	Supap Keçesi Valve Stem Seal Ventilschaft Queue de soupape	
						
 61215025 5893816		 61215019x4 5414228	 61215021x4 5452930	 61215017 95494600		
 60138045 500388382	 60146066 7301683	 60146019x4 98425767	 60147021x4 98434020			
 60138047 0249.C3	 60138068 500327440					

 : Delik - Çentik

 : Hole - Notch

 : Trou - Entaille

NOT: Katalogdaki Orijinal Kodlar Referans Amacıyla Kullanılmıştır.Lütfen COTECH Kodlarını Kullanınız.
Original codes used for reference only.Please use COTECH codes for orders.

FIAT

00



Silindir Kapak
Cylinder Head
Zylinderkopf
Joint de culasse

01



02



03



04

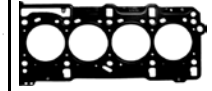

Ltr	MODEL	PS/KW	ENGINE/MOTOR		
2,8 2799	4 CYL ø94,4 DUCATO 11/00--> DUCATO JTD	128 PS / 94 KW 126 PS / 93 KW	8140.43S	60139100 71713696	<p>60139005 99458402 1,50mm</p> <p>60139006 99460983 1,40mm</p> <p>60139007 99432353 1,30mm ø96</p>
2,8 2799	4 CYL ø94,4 DUCATO 02/98-->04/02 DUCATO D	87 PS / 64 KW	8140.63	<p>60147105 500306172 1,80mm</p> <p>60147106 500306171 1,70mm</p> <p>60147107 500306170 1,60mm ø96</p>	

▲ : İçerikte Bulunmamaktadır...

▲ : Not included in the set

▲ : Non inclus dans la pochette

00: Motor Takım Keçesiz ve Subap Lastiksiz











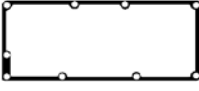

00: Gasket Set Without oil seals Without Valve Stem Seal

01: Motor Takım Keçesiz - Subap Lastikli

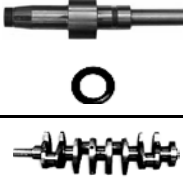
01: Gasket set With Valve Stem Seal Without Oil Seals

02: Motor Full Takım Keçeli ve Subap Lastikli

02: Gasket Full Set With oil seals and Valve Stem Seals

<p>Subap Kapak Valve Cover Gasket Zylinderkopfhaube Couvre-culbut.</p> 	<p>Karter Oil Pan Ölwanne Carter d'huile</p> 	<p>Emme Manifold Intake Manifold Ansaug Admission</p> 	<p>Egzoz Manifold Exhaust Manifold Auspuffkrümmer Collecteur D'echappement</p> 	<p>Eksoz Boğaz Exhaust Pipe Auspuff Kehle</p> 	<p>Supap Keçesi Valve Stem Seal Ventilschaft Queue de soupape</p> 	
 <p>60138045 500388382</p>  <p>60138047 500388381</p>	 <p>60138068 98446492</p>	 <p>60146019x4 98425767</p>	 <p>60147021x4 98434020</p>			

■ : Delik - Çentik

■ : Hole - Notch

■ : Trou - Entaille

NOT: Katalogdaki Orijinal Kodlar Referans Amacıyla Kullanılmıştır.Lütfen COTECH Kodlarını Kullanınız.
Original codes used for reference only.Please use COTECH codes for orders.

FORD

00



01



02



03







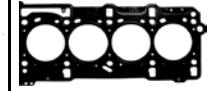

04



Silindir Kapak
Cylinder Head
Zylinderkopf
Joint de culasse

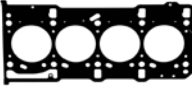

Ltr MODEL PS/KW ENGINE/MOTOR

Ltr	MODEL	PS/KW	ENGINE/MOTOR		
1,3 1248	4 CYL ø69,6 KA TDCI 16V (DOCH) 10/08-->	75 PS / 55 KW	13DDOX FD4	<p>62427402 Motor Full Takım Gasket Full Set</p>   <p>62427403 1 564 796</p>  <p>62427404 1 564 795</p> 	 <p>62427505 1 538 719 0,72mm</p> <p>62427506 1 538 721 0,82mm 1 ■</p> <p>62427507 1 538 722 0,92mm 2 ■ MLS ø70,5</p>
1,3 1323	4 CYL ø71 FESTIVA (SOCH) 1988-->1993	69 / PS / 51 KW	B3		 <p>61410605 B302-10-271 1,60mm</p> <p>61410606 B302-10-271 2,00mm ø74</p>

▲ : İçerikte Bulunmamaktadır...

▲ : Not included in the set

▲ : Non inclus dans la pochette

00: Motor Takım Keçesiz ve Subap Lastiksiz







00: Gasket Set Without oil seals Without Valve Stem Seal

01: Motor Takım Keçesiz - Subap Lastikli

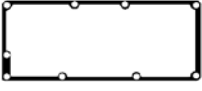
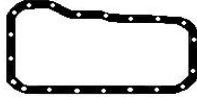
01: Gasket set With Valve Stem Seal Without Oil Seals

02: Motor Full Takım Keçeli ve Subap Lastikli

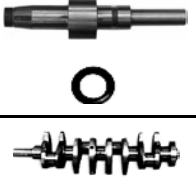
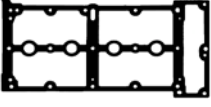
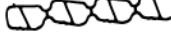
02: Gasket Full Set With oil seals and Valve Stem Seals

<p>Subap Kapak Valve Cover Gasket Zylinderkopfhaube Couvre-culbut.</p> 	<p>Karter Oil Pan Ölwanne Carter d'huile</p> 	<p>Emme Manifold Intake Manifold Ansaug Admission</p> 	<p>Egzoz Manifold Exhaust Manifold Auspuffkrümmer Collecteur D'echappement</p> 	<p>Eksoz Boğaz Exhaust Pipe Auspuff Kehle</p> 	<p>Supap Keçesi Valve Stem Seal Ventilschaft Queue de soupape</p> 	
 <p>62427425 1 563 470</p>		 <p>62427417 1 539 476</p>	 <p>62427421 1 538 710</p>		 <p>62427426x16 1 547 971 6x8,8x11,7x9,5</p>	<p>21204023 40x52x7 RD</p> <p>21204034 78X100X9 RD</p>

■ : Delik - Çentik

■ : Hole - Notch

■ : Trou - Entaille

NOT: Katalogdaki Orijinal Kodlar Referans Amacıyla Kullanılmıştır.Lütfen COTECH Kodlarını Kullanınız.
Original codes used for reference only.Please use COTECH codes for orders.

00



01



02



03



04



Silindir Kapak
Cylinder Head
Zylinderkopf
Joint de culasse

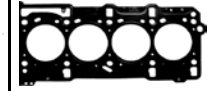

Ltr	MODEL	PS/KW	ENGINE/MOTOR		
1,4 1398	4 CYL ø73,7 FIESTA TDCI 11/01--> FUSION TDCI	70 PS / 51 KW 68 PS / 50 KW	F6JA F6JB F6JD DURATORQ (14DS4X)	<p>61706002 Motor Full Takım Gasket Full Set</p> <p>61706003 Motor Üst Takım Gasket Head Set</p> <p>61706004 Motor Alt Takım Conversion Set</p>	<p>61706005 1 146 053 1,45mm 1</p> <p>61706006 1 146 052 1,40mm 4</p> <p>61706007 1 146 050 1,30mm 3</p> <p>61706008 1 146 049 1,25mm 2</p> <p>61706009 1 146 051 1,35mm 1 MLS ø75</p>
1,6 1560	4 CYL ø75 C-MAX TDCI 10/03--> FIESTA TDCI FOCUS TDCI FUSION TDCI (DOCH 16 V)	109 PS / 80 KW 75 PS / 55 KW	G8DA G8DB G8DC G8DD G8DE G8DF HHDA HHDB HHJA HHJB HHJC HHJD HHJE HHJF MTDA UBJA DURATORQ(16DDOX)	<p>61707002 Motor Full Takım Gasket Full Set</p> <p>61707003 Motor Üst Takım Gasket Head Set</p> <p>61707004 Motor Alt Takım Conversion Set</p>	<p>61707005 1 229 881 1,45mm 5</p> <p>61707006 1 229 880 1,40mm 4</p> <p>61707007 1 229 878 1,30mm 3</p> <p>61707008 1 229 877 1,25mm 2</p> <p>61707009 1 229 879 1,35mm 1 MLS ø76</p>

▲ : İçerikte Bulunmamaktadır...

▲ : Not included in the set

▲ : Non inclus dans la pochette

00: Motor Takım Keçesiz ve Subap Lastiksiz











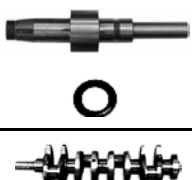
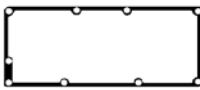

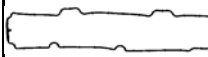
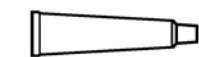

00: Gasket Set Without oil seals Without Valve Stem Seal

01: Motor Takım Keçesiz - Subap Lastikli

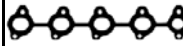
01: Gasket set With Valve Stem Seal Without Oil Seals

02: Motor Full Takım Keçeli ve Subap Lastikli

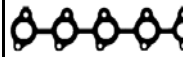
02: Gasket Full Set With oil seals and Valve Stem Seals

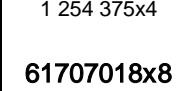
Subap Kapak Valve Cover Gasket Zylinderkopfhaube Couvre-culbut.	Karter Oil Pan Ölwanne Carter d'huile	Emme Manifold Intake Manifold Ansaug Admission	Egzoz Manifold Exhaust Manifold Auspuffkrümmer Collecteur D'echappement	Eksoz Boğaz Exhaust Pipe Auspuff Kehle	Supap Keçesi Valve Stem Seal Ventilschaft Queue de soupape	
						
						2120417 27x47x7 RD
61706025 1 148 101	62427465	61706019x4 1 148 106	61706021 1 148 115		61706027x8 5,5x9,5x22,9x17,5	21204018 40x55x6,4 RD
						21204017 27x47x7 RD
61707025 1 235 994	62427465	 1 254 376x4  1 254 375x4 61707018x8 SET	61706021 1 148 115		61707026x16 5,5x9,5x18,1x14	21204018 40x55x6,4 RD 21204019 85x105x8,8 LD

 : Delik - Çentik

 : Hole - Notch

 : Trou - Entaille

NOT: Katalogdaki Orijinal Kodlar Referans Amacıyla Kullanılmıştır.Lütfen COTECH Kodlarını Kullanınız.
Original codes used for reference only.Please use COTECH codes for orders.

00



Silindir Kapak
Cylinder Head

01



Zylinderkopf

02



Joint de culasse

03



04



Ltr	MODEL	PS/KW	ENGINE/MOTOR		
1,6 1596	4 CYL ø79 C-MAX 16 V FOCUS 16 V FIESTA 16 V FUSION 16 V (DOCH)	10/03-->	100 PS / 74 KW HWDA ZETEC-S(16HDEZ) FYJA		 62218205 1 305 949 1,20mm FIBER / FIBRE ø80
1,6 1597	4 CYL ø82,7 KA STREET	05/03-->11/08	95 PS / 70 KW CDB CDC CDRA CDRB		 61218105 1 099 084 1,20mm FIBER / FIBRE ø83
1,8 1781	4 CYL ø81 BELINA DEL REY ESCORT PAMPA SCALA VERONA ROYALE VERSAILLES (BRASIL)	1989-->1996	85 PS / 62 KW AP	61408002 Motor Full Takım Gasket Full Set 61408003 027 198 012 L 61402004 037 198 011 C	 61408005 026 103 383K 1,75mm ø83
1,8 1796	4 CYL ø78 COURIER	1972-->1980	VB	61420002 8051-99-100	 61420005 R201-10-271F 1,50mm 61420006 R201-10-271F 2,00mm ø80

▲ : İçerikte Bulunmamaktadır...

▲ : Not included in the set

▲ : Non inclus dans la pochette

00: Motor Takım Keçesiz ve Subap Lastiksiz











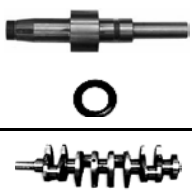
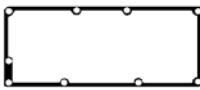



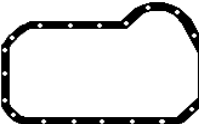

00: Gasket Set Without oil seals Without Valve Stem Seal

01: Motor Takım Keçesiz - Subap Lastikli

01: Gasket set With Valve Stem Seal Without Oil Seals

02: Motor Full Takım Keçeli ve Subap Lastikli

02: Gasket Full Set With oil seals and Valve Stem Seals

Subap Kapak Valve Cover Gasket Zylinderkopfhaube Couvre-culbut.	Karter Oil Pan Ölwanne Carter d'huile	Emme Manifold Intake Manifold Ansaug Admission	Egzoz Manifold Exhaust Manifold Auspuffkrümmer Collecteur D'echappement	Eksoz Boğaz Exhaust Pipe Auspuff Kehle	Supap Keçesi Valve Stem Seal Ventilschaft Queue de soupape	
						
 61401034 026 198 025 A	 61401013 028 103 609 A	 61401019 026129717D	 61401021x4 026 129 589 A	 61401017 841 253 115 B	 60107027x8 8x10,8x14,2x10	21201075x3 32x47x10 WD 21204504 85X105X12 LD
 61420034 022110235A	 61420013 0221-10-431	 61420019 038113111A	 61420020 0221-13-462	 61420017 802B-13-483		21201026 48x70x12 RD 21201205 80x105x13 LD

 : Delik - Çentik

 : Hole - Notch

 : Trou - Entaille

NOT: Katalogdaki Orijinal Kodlar Referans Amacıyla Kullanılmıştır.Lütfen COTECH Kodlarını Kullanınız.
Original codes used for reference only.Please use COTECH codes for orders.

FORD

00



01



02



03







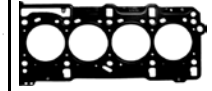

04



Silindir Kapak
Cylinder Head
Zylinderkopf
Joint de culasse



Ltr	MODEL	PS/KW	ENGINE/MOTOR		
1,9 1896	4 CYL ø79,5 GALAXY TDI 03/95-->05/06	90 PS / 66 KW	1Z AFN AHU	<p>61405202 Motor Full Takım Gasket Full Set</p>   <p>61405203 1 009 167</p>  <p>61405104 1 004 926</p> 	 <p>61405207 1 079 766 1 005 254 1,45mm 1 M</p> <p>61405206 1 079 767 1 005 258 1,53mm 2 M</p> <p>61405205 1 079 768 1 005 261 1,61mm 3 M</p> <p>MLS ø81</p>
2,0 1984	4 CYL ø82,5 VERSAILLES ROYALE ESCORT VERONA (BRASIL) 1992-->1995		AP	<p>61408102</p>	 <p>61408105 048 103 383B 1,75mm ø83,5</p>
2,0 1999	4 CYL ø87,5 C-MAX 16 V FIESTA 16 V FOCUS 16 V GALAXY 16 V MONDEO 16 V S-MAX 16 V FUSION 16 V 03/04-->	150 PS / 110 KW 145 PS / 107 KW	AOBA AOBC AODA AODB AODE AOWA AOWB N4JB SYDA TBBA TBBB TBWA TBWB CJBA DURATEC-HE(20HDEA)		 <p>61420405 1 229 872 1,20mm FIBER / FIBRE ø89</p>

▲ : İçerikte Bulunmamaktadır...

▲ : Not included in the set

▲ : Non inclus dans la pochette

00: Motor Takım Keçesiz ve Subap Lastiksiz











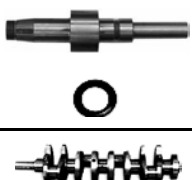
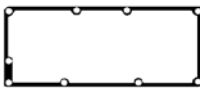

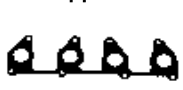

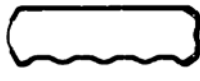

00: Gasket Set Without oil seals Without Valve Stem Seal

01: Motor Takım Keçesiz - Subap Lastikli

01: Gasket set With Valve Stem Seal Without Oil Seals

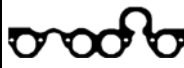
02: Motor Full Takım Keçeli ve Subap Lastikli

02: Gasket Full Set With oil seals and Valve Stem Seals

Subap Kapak Valve Cover Gasket Zylinderkopfhaube Couvre-culbut.	Karter Oil Pan Ölwanne Carter d'huile	Emme Manifold Intake Manifold Ansaug Admission	Egzoz Manifold Exhaust Manifold Auspuffkrümmer Collecteur D'echappement	Eksoz Boğaz Exhaust Pipe Auspuff Kehle	Supap Keçesi Valve Stem Seal Ventilschaft Queue de soupape	
						
 61405225 028 103 483 C 028 103 483 G	 61401014 1 033 121	 61405121 1 006 217	 61401021x4 026 129 589 A 028 129 589 B		 60107027x8 1 669 785 8x10,8/14,2x10	21201075x3 32x47x10 WD 21204504 85x105x12 LD
 61401034 026 198 025 A	 61401013 028 103 609 A	 61401019 026 129 717 D	 61401021x4 026 129 589 A 056 129 589 B	 61408017 841 253 115 B	 60107027x8 026 109 675 8x10,8/14,2x10	21201075x3 32x47x10 W 21204504 85x105x12 LD

 : Delik - Çentik

 : Hole - Notch

 : Trou - Entaille

NOT: Katalogdaki Orijinal Kodlar Referans Amacıyla Kullanılmıştır.Lütfen COTECH Kodlarını Kullanınız.
Original codes used for reference only.Please use COTECH codes for orders.

00



Silindir Kapak
Cylinder Head
Zylinderkopf
Joint de culasse

01



02



03



04

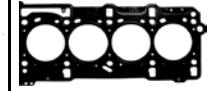

Ltr	MODEL	PS/KW	ENGINE/MOTOR		
2,1 2112	4 CYL ø90 GRANADA 08/77-->08/82 DIESEL	63PS / 47KW	GD21	61212002 0198.40	<p>61212005 1 576 302 1,60mm</p> <p>61212006 1 576 302 1,80mm</p> <p>ø94</p>
2,2 2184	4 CYL ø86 PROBE 12 V 08/88-->07/93 PROBE TURBO 12 V RANGER 12 V 03/99-->07/03	112 PS / 82 KW 147 PS / 108 KW	F2		<p>61420305 F202-10-271 1,40mm</p> <p>61420306 F202-10-271 1,80mm</p> <p>ø87,5</p>
2,2 2209	4 CYL ø92 RANGER 2WD	63 PS / 46 KW	S2		<p>41480005 0527-10-271A Ø 97</p>
2,3 2261	4 CYL ø87,5 MAVERICK 16V 03/04--> (DOCH) 04/06--> TRANSIT	150 PS / 110 KW 145 PS / 107 KW	GZ GZFA GZFC		<p>61420405 1 229 872 1,20mm FIBER / FIBRE</p> <p>ø89</p>

▲ : İçerikte Bulunmamaktadır...

▲ : Not included in the set

▲ : Non inclus dans la pochette

00: Motor Takım Keçesiz ve Subap Lastiksiz











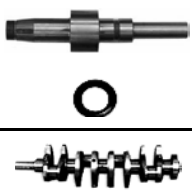
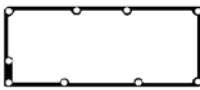



00: Gasket Set Without oil seals Without Valve Stem Seal

01: Motor Takım Keçesiz - Subap Lastikli

01: Gasket set With Valve Stem Seal Without Oil Seals

02: Motor Full Takım Keçeli ve Subap Lastikli

02: Gasket Full Set With oil seals and Valve Stem Seals

Subap Kapak Valve Cover Gasket Zylinderkopfhaube Couvre-culbut.	Karter Oil Pan Ölwanne Carter d'huile	Emme Manifold Intake Manifold Ansaug Admission	Egzoz Manifold Exhaust Manifold Auspuffkrümmer Collecteur D'echappement	Eksoz Boğaz Exhaust Pipe Auspuff Kehle	Supap Keçesi Valve Stem Seal Ventilschaft Queue de soupape	
						
 61212525 1 651 701	 61212014 0313.19  61212015 0304.12	 61212016x3 0348.11	 61212020x2 1 576 449	 61205018 1710.07  61212018 1710.15  61212019 1710.19		21201020 42x60x10 RD

 : Delik - Çentik

 : Hole - Notch

 : Trou - Entaille

NOT: Katalogdaki Orijinal Kodlar Referans Amacıyla Kullanılmıştır.Lütfen COTECH Kodlarını Kullanınız.
Original codes used for reference only.Please use COTECH codes for orders.

00



01



02



03









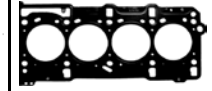

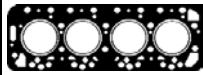

04

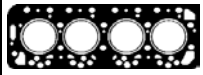

Silindir Kapak
Cylinder Head
Zylinderkopf
Joint de culasse



Ltr	MODEL	PS/KW	ENGINE/MOTOR		
2,3 2304	4 CYL ø94 SIERRA D 08/82-->02/93	67 PS / 49 KW	YTR YTT(XDP2)	61218000 0198.94 	 61218005 6 812 074 1,73mm 4  61218006 6 812 073 1,63mm 3  61218007 6 812 072 1,53mm 2  ø96
2,3 2346	4 CYL ø91 RANGER 2WD C RANGER 4WD D BRONCO II TD 1985-->1987	82 PS / 67 KW	4D55T	61450001 MD050092  61450002 MD050092	 61450005 MD050545 1,80mm ø92,5
2,5 2498	4 CYL ø94 GRANADA SCORPIO SCORPIO TD GRANADA TD 08/82-->07/93	92 PS / 68 KW 69 PS / 51 KW	SFA SFB STP STR XD3	61218000 0198.94 	 61218005 6 812 074 1,73mm 4  61218006 6 812 073 1,63mm 3  61218007 6 812 072 1,53mm 2  ø96

▲ : İçerikte Bulunmamaktadır...

▲ : Not included in the set

▲ : Non inclus dans la pochette

00: Motor Takım Keçesiz ve Subap Lastiksiz











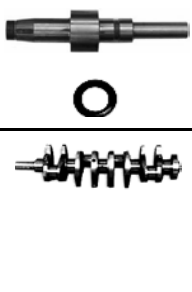
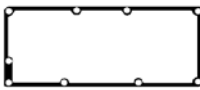









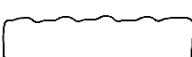

00: Gasket Set Without oil seals Without Valve Stem Seal

01: Motor Takım Keçesiz - Subap Lastikli

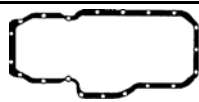
01: Gasket set With Valve Stem Seal Without Oil Seals

02: Motor Full Takım Keçeli ve Subap Lastikli

02: Gasket Full Set With oil seals and Valve Stem Seals

Subap Kapak Valve Cover Gasket Zylinderkopfhaube Couvre-culbut.	Karter Oil Pan Ölwanne Carter d'huile	Emme Manifold Intake Manifold Ansaug Admission	Egzoz Manifold Exhaust Manifold Auspuffkrümmer Collecteur D'echappement	Eksoz Boğaz Exhaust Pipe Auspuff Kehle	Supap Keçesi Valve Stem Seal Ventilschaft Queue de soupape	
						
 61212525 1 651 701	 61212014 6 894 122  61212015 0304.12	 61212016x3 0348.11	 61212020x2 0349.10	 61212018 1710.15  61212019 1710.19		
 61450025 MD050312	 61450013 MD149392	 61450021 MD050482			 61450026x8 8x13x9x13	21201013 35x50x8 RD 21201023 44x60x7 RD 21201035 80x96x9 LD 21201004 25x35x6 21201001 17x28x7
 61212525 1 651 701	 61212014 6 894 122  61212015 0304.12	 61212016x3 0348.11	 61212020x2 0349.10	 61212018 1710.15  61212019 1710.19		

 : Delik - Çentik

 : Hole - Notch

 : Trou - Entaille

NOT: Katalogdaki Orijinal Kodlar Referans Amacıyla Kullanılmıştır. Lütfen COTECH Kodlarını Kullanınız.
Original codes used for reference only. Please use COTECH codes for orders.

00



Silindir Kapak

Cylinder Head

01



Zylinderkopf

02



Joint de culasse

03



04

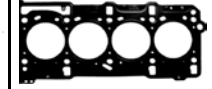

Ltr	MODEL	PS/KW	ENGINE/MOTOR	
1,2 1238 1,3 1335	4 CYL ø72 CIVIC 03/77-->12/80 CIVIC 09/79-->09/83	54 PS / 40 KW 60 PS / 44 KW	EB1 EB2 EB3 EN1 EN4	 61430005 12251-634-010 1,40mm ø74
1,6 1602	4 CYL ø77 ACCORD 01/78-->09/93 QUINTET PRELUDE	80 PS / 59 KW	EG EL EL14	 61440005 12251-PC1-000 1,40mm ø78

▲ : İçerikte Bulunmamaktadır...

▲ : Not included in the set

▲ : Non inclus dans la pochette

00: Motor Takım Keçesiz ve Subap Lastiksiz





00: Gasket Set Without oil seals Without Valve Stem Seal

01: Motor Takım Keçesiz - Subap Lastikli

01: Gasket set With Valve Stem Seal Without Oil Seals

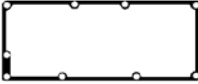
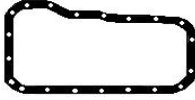
02: Motor Full Takım Keçeli ve Subap Lastikli

02: Gasket Full Set With oil seals and Valve Stem Seals

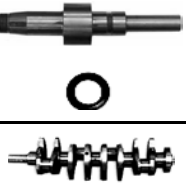
<p>Subap Kapak Valve Cover Gasket Zylinderkopfhaube Couvre-culbut.</p> 	<p>Karter Oil Pan Ölwanne Carter d'huile</p> 	<p>Emme Manifold Intake Manifold Ansaug Admission</p> 	<p>Egzoz Manifold Exhaust Manifold Auspuffkrümmer Collecteur D'echappement</p> 	<p>Eksoz Boğaz Exhaust Pipe Auspuff Kehle</p> 	<p>Supap Keçesi Valve Stem Seal Ventilschaft Queue de soupape</p> 	

■ : Delik - Çentik

■ : Hole - Notch

■ : Trou - Entaille

NOT: Katalogdaki Orijinal Kodlar Referans Amacıyla Kullanılmıştır.Lütfen COTECH Kodlarını Kullanınız.
Original codes used for reference only.Please use COTECH codes for orders.

00



Silindir Kapak
Cylinder Head
Zylinderkopf
Joint de culasse

01



02



03



04

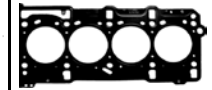

Ltr	MODEL	PS/KW	ENGINE/MOTOR		
1,1 1086	4 CYL ø67 ATOS PRIME 12V 06/05-->01/07 (SOCH)	63 PS / 46 KW	G4HG		
1,3 1298	4 CYL ø71 PONY 10/89-->01/95 (SOCH)	58 PS / 43 KW	G4M G13B G4DG		
1,3 1341	4 CYL ø71,5 ACCENT 12V 10/94-->01/000 GETZ 12V 09/02-->09/05 (SOCH)	82 PS / 60 KW 84 PS / 62 KW	G4EA	61500002 Motor Full Takım Gasket Full Set	
1,4 1399	4 CYL ø75,5 GETZ 16V 08/05-->11/10 ACCENT 16V VERNA 16V (DOCH)	97 PS / 71 KW	G4EE		
1,4 1396	4 CYL ø77 ix30 16V 10/07-->11/11 ix20 16V 09/08-->	105 PS / 77 KW 109 PS / 80 KW 90 PS / 66 KW 101 PS / 74 KW	G4FA		



61410405
22311-02760
1,20mm
FIBER / FIBRE
ø68



61507005
MD066163
1,40mm
ø72,5



61500005
22311-22360
1,40mm
FIBER / FIBRE
ø73mm

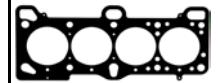

61410505
22311-26603
1,20mm
FIBER / FIBRE
ø77

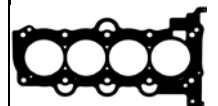

61510106
22311-2B003
1,20mm
FIBER / FIBRE
ø78,5

▲ : İçerikte Bulunmamaktadır...

▲ : Not included in the set

▲ : Non inclus dans la pochette

00: Motor Takım Keçesiz ve Subap Lastiksiz











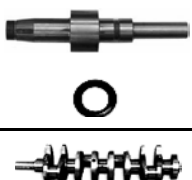
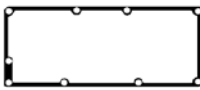

00: Gasket Set Without oil seals Without Valve Stem Seal

01: Motor Takım Keçesiz - Subap Lastikli

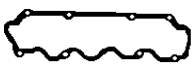
01: Gasket set With Valve Stem Seal Without Oil Seals

02: Motor Full Takım Keçeli ve Subap Lastikli

02: Gasket Full Set With oil seals and Valve Stem Seals

Subap Kapak Valve Cover Gasket Zylinderkopfhaube Couvre-culbut.	Karter Oil Pan Ölwanne Carter d'huile	Emme Manifold Intake Manifold Ansaug Admission	Egzoz Manifold Exhaust Manifold Auspuffkrümmer Collecteur D'echappement	Eksoz Boğaz Exhaust Pipe Auspuff Kehle	Supap Keçesi Valve Stem Seal Ventilschaft Queue de soupape	
						
 61490025 22441-22012	 61490013 21451-21010	 61490018 28411-26600  61490016	 61490021 28521-22020	 61490017 22224-22000	 61490027x12 22224-22000 6x11x6x10,2	21201011 35x50x8 RD 21201032 72x96x9 LD

 : Delik - Çentik

 : Hole - Notch

 : Trou - Entaille

NOT: Katalogdaki Orijinal Kodlar Referans Amacıyla Kullanılmıştır.Lütfen COTECH Kodlarını Kullanınız.
Original codes used for reference only.Please use COTECH codes for orders.

00



Silindir Kapak

Cylinder Head

01



Zylinderkopf

02



Joint de culasse

03



04

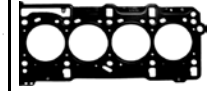

Ltr	MODEL	PS/KW	ENGINE/MOTOR		
1,5 1468	4 CYL ø75,5 EXCELL PONY LANTRA S-COUPE (SOCH) 10/85-->05/96	86 PS / 63 KW 72 PS / 53 KW	G15B G4DJ G4J		<p>61500305 MD016163 1,40mm</p> <p>61500306 MD016163 2,00mm ø76,5</p>
1,5 1495	4 CYL ø75,5 ACCENT LANTRA S COUPE (SOCH) 10/94-->01/00	88 PS / 65 KW	G4EK	61490002 20910-22A00	<p>61490005 22311-22130 1,40mm FIBER / FIBRE ø77</p>
1,6 1591	4 CYL ø77 i30 i20 ix20 10/07-->11/11 09/08--> 11/10-->	116 PS / 85 KW 126 PS / 93 KW 125 PS / 92 KW	G4FC		<p>61510106 22311-2B003 1,20mm FIBER / FIBRE ø78,5</p>

▲ : İçerikte Bulunmamaktadır...

▲ : Not included in the set

▲ : Non inclus dans la pochette

00: Motor Takım Keçesiz ve Subap Lastiksiz











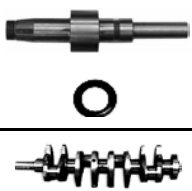
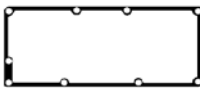



00: Gasket Set Without oil seals Without Valve Stem Seal

01: Motor Takım Keçesiz - Subap Lastikli

01: Gasket set With Valve Stem Seal Without Oil Seals

02: Motor Full Takım Keçeli ve Subap Lastikli

02: Gasket Full Set With oil seals and Valve Stem Seals

Subap Kapak Valve Cover Gasket Zylinderkopfhaube Couvre-culbut.	Karter Oil Pan Ölwanne Carter d'huile	Emme Manifold Intake Manifold Ansaug Admission	Egzoz Manifold Exhaust Manifold Auspuffkrümmer Collecteur D'echappement	Eksoz Boğaz Exhaust Pipe Auspuff Kehle	Supap Keçesi Valve Stem Seal Ventilschaft Queue de soupape	
						
						21201011 35x50x8 RD
61490025 22441-22012	61490013 21451-21010	61490018 28411-26600	61490021 28521-22020	61490017 22224-22000	61490027x12 22224-22000 6x11x6x10,2	21201032 72x96x9 LD
						
		61490016				

 : Delik - Çentik

 : Hole - Notch

 : Trou - Entaille

NOT: Katalogdaki Orijinal Kodlar Referans Amacıyla Kullanılmıştır.Lütfen COTECH Kodlarını Kullanınız.
Original codes used for reference only.Please use COTECH codes for orders.

00



Silindir Kapak
Cylinder Head

01



Zylinderkopf

02









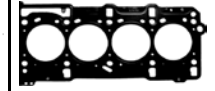

Joint de culasse

03



04



Ltr	MODEL	PS/KW	ENGINE/MOTOR		
1,8 1795	4 CYL ø82 ELANTRA 16V LAVITA 16V MATRIX 16V	122 PS / 90 KW	G4GB G4GB2		61418005 22311-23700 1,20mm FIBER / FIBRE ø84
1,9 1,905	4 CYL ø83 LANTRA (SOCH) 03/98-->10/00	68 PS / 50 KW	XUD9	61204002 0197.H5  61204003 0197.H4 	61204009 0209.S5 1,36 mm 1  61204008 0209.S6 1,40 mm 2  61204007 0209.S7 1,44 mm 3  61204006 0209.S8 1,48 mm 4  61204005 0209.S9 1,53 mm 5  ø 84
2,00 1975	4 CYL ø82 ELANTRA 16V TUSCON 16V i 30 16V COUPE 16V (DOCH) 06/00-->07/06 08/04-->03/10	141 PS / 104 KW 143 PS / 105 KW	G4GC		61418005 22311-23700 1,20mm FIBER / FIBRE ø84
2,0 1997	4 CYL ø85 SONATA SANTAMO 09/88-->08/91	101 PS / 74 KW	G4P		61500905 MD040533 1,40mm 61500906 MD040533 2,00mm ø86

▲ : İçerikte Bulunmamaktadır...

▲ : Not included in the set

▲ : Non inclus dans la pochette

00: Motor Takım Keçesiz ve Subap Lastiksiz











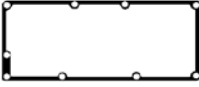



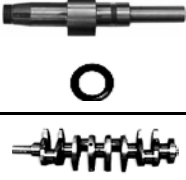

00: Gasket Set Without oil seals Without Valve Stem Seal

01: Motor Takım Keçesiz - Subap Lastikli

01: Gasket set With Valve Stem Seal Without Oil Seals

02: Motor Full Takım Keçeli ve Subap Lastikli

02: Gasket Full Set With oil seals and Valve Stem Seals

<p>Subap Kapak Valve Cover Gasket Zylinderkopfhaube Couvre-culbut.</p> 	<p>Karter Oil Pan Ölwanne Carter d'huile</p> 	<p>Emme Manifold Intake Manifold Ansaug Admission</p> 	<p>Egzoz Manifold Exhaust Manifold Auspuffkrümmer Collecteur D'echappement</p> 	<p>Eksoz Boğaz Exhaust Pipe Auspuff Kehle</p> 	<p>Supap Keçesi Valve Stem Seal Ventilschaft Queue de soupape</p> 	
 <p>61203525 0249.46 0249.91</p>	 <p>61203013 0304.34</p>  <p>61203014 93501565</p>	 <p>61203116x2 9456044080</p>  <p>61203018x2 91508659</p>  <p>61203120x2 0349.47 93010402</p>  <p>61203021 0348.JO</p>	 <p>61205019 1721.01 7810024000</p>	 <p>60107027x8 0956.22 8x10,8/14,2x10</p>	<p>21201011x2 35x50x8 WD</p> <p>21201019 42x62x8 RD</p> <p>21201040 90x110x7 LD</p>	

■ : Delik - Çentik

■ : Hole - Notch

■ : Trou - Entaille

NOT: Katalogdaki Orijinal Kodlar Referans Amacıyla Kullanılmıştır.Lütfen COTECH Kodlarını Kullanınız.
Original codes used for reference only.Please use COTECH codes for orders.

00



01



02



03



04



Silindir Kapak
Cylinder Head
Zylinderkopf
Joint de culasse

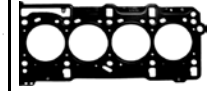

Ltr	MODEL	PS/KW	ENGINE/MOTOR		
2,0 1997	4 CYL ø85 SONATA 16V 06/98--> TRAJET 16V SANTA FE 16V (DOCH)	136 PS / 100 KW 131 PS / 96 KW	G4BP G4JP-EG G4JP-G G43P		 61510005 22311-38100 1,20mm FIBER / FIBRE ø86
2,4 2359	4 CYL ø88 SONATA NF 16V 01/05--> (DOCH)	162 PS / 119 KW	G4KC		 61419005 22311-25211 1,20mm FIBER / FIBRE 61419006 22311-25211 1,80mm FIBER / FIBRE ø90
2,4 2351	4 CYL ø86,5 SONATA EF 16V 99-->01 SANTA FE 16V (DOCH)	135 PS / 99 KW 146 PS / 100 KW	G4JS2		 61510205 22311-38200 1,20mm FIBER/FIBRE
2,5 2476	4 CYL ø91 H100 D 12/94-->03/00 H100 (AU) 10/97-->04/04 H1 H100TD H1 TD H1 TCI GALLOPER TD LIBERO LEBERO TCI	78PS / 57 KW 80 PS / 59 KW 99 PS / 73 KW 101 PS / 74 KW	D4BA/X D4BF D4BH 4D56TCI D4BF/D4BH 4D56	61450001 MD050092 61450002 MD050092	 61450005 MD050545 1,80mm ø92,5
2,5 2497	4 CYL ø91 H-1 CRDI 08/03-->04/04	140 PS / 103 KW	D4CB		 61415505 22311-4A000 1,40mm FIBER / FIBRE ø92,5

▲ : İçerikte Bulunmamaktadır...

▲ : Not included in the set

▲ : Non inclus dans la pochette

00: Motor Takım Keçesiz ve Subap Lastiksiz









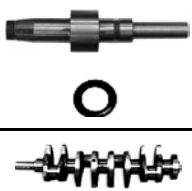
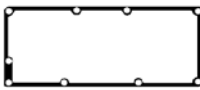

00: Gasket Set Without oil seals Without Valve Stem Seal

01: Motor Takım Keçesiz - Subap Lastikli

01: Gasket set With Valve Stem Seal Without Oil Seals

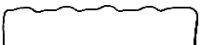
02: Motor Full Takım Keçeli ve Subap Lastikli

02: Gasket Full Set With oil seals and Valve Stem Seals

Subap Kapak Valve Cover Gasket Zylinderkopfhaube Couvre-culbut.	Karter Oil Pan Ölwanne Carter d'huile	Emme Manifold Intake Manifold Ansaug Admission	Egzoz Manifold Exhaust Manifold Auspuffkrümmer Collecteur D'echappement	Eksoz Boğaz Exhaust Pipe Auspuff Kehle	Supap Keçesi Valve Stem Seal Ventilschaft Queue de soupape	
						
						21201013 35x50x8 RD
61450025 MD050312	61450013 MD149392	61450021 MD050482			61450026x8 8x13x9x13	21201023 44x60x7 RD 21201035 80x96x9 LD 21201004 25x35x6 21201001 17x28x7

■ : Delik - Çentik

■ : Hole - Notch

■ : Trou - Entaille

NOT: Katalogdaki Orijinal Kodlar Referans Amacıyla Kullanılmıştır.Lütfen COTECH Kodlarını Kullanınız.
Original codes used for reference only.Please use COTECH codes for orders.

00



01



02



03









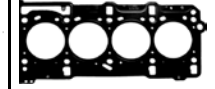



04



Silindir Kapak
Cylinder Head
Zylinderkopf
Joint de culasse



Ltr	MODEL	PS/KW	ENGINE/MOTOR		
2,5 2476	4 CYL ø91 GALLOPER TCi 07/93--> GALLOPER TD GRACE D GRACE TD H-1 TD H100 D H100 TD PORTER TCi PORTER TD STAREX TCi STAREX TD TERRACAN D TERRACAN TD	105 PS / 77 KW 75 PS / 55 KW	D4BA D4BF D4BH D4BX	61470002 1000A901 	 61470005 MD302893 1,60mm 5  61470006 22311-42525 1,55mm 4  61470007 22311-42855 1,50mm 3  61470008 22311-42515 1,45mm 2  ø92,5
2,6 2607	4 CYL ø91 H100 D 04/96-->09/99 H100 (AU) H1 H100 (AU-M)	85 PS / 60 KW	D4BB	61450001 MD050092  61450002 MD050092	 61450005 MD050545 1,80mm ø92,5
3,3 3342	3 CYL ø92 SONATA V 01/08-->	250 PS / 184 KW	G6DB		61510305  22311-3C140 1,50mm FIBER / FIBRE  22311-3C130 1,50mm FIBER / FIBRE ø93,5

▲ : İçerikte Bulunmamaktadır...

▲ : Not included in the set

▲ : Non inclus dans la pochette

00: Motor Takım Keçesiz ve Subap Lastiksiz











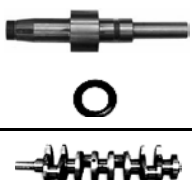
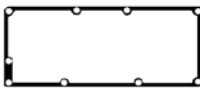

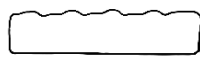

00: Gasket Set Without oil seals Without Valve Stem Seal

01: Motor Takım Keçesiz - Subap Lastikli

01: Gasket set With Valve Stem Seal Without Oil Seals

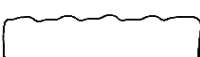
02: Motor Full Takım Keçeli ve Subap Lastikli

02: Gasket Full Set With oil seals and Valve Stem Seals

Subap Kapak Valve Cover Gasket Zylinderkopfhaube Couvre-culbut.	Karter Oil Pan Ölwanne Carter d'huile	Emme Manifold Intake Manifold Ansaug Admission	Egzoz Manifold Exhaust Manifold Auspuffkrümmer Collecteur D'echappement	Eksoz Boğaz Exhaust Pipe Auspuff Kehle	Supap Keçesi Valve Stem Seal Ventilschaft Queue de soupape	
						
 61450025 MD050312	 61450013 MD149392	 61470021 28520-42070			 61450026x8 8x13x9x13	21201013 35x50x8 RD 21201023 44x60x7 RD 21201035 80x96x9 LD 21201004 25x35x6 21201001 17x28x7
 61450025 MD050312	 61450013 MD149392	 61450021 MD050482			 61450026x8 8x13x9x13	21201013 35x50x8 RD 21201023 44x60x7 RD 21201035 80x96x9 LD 21201004 25x35x6 21201001 17x28x7

■ : Delik - Çentik

■ : Hole - Notch

■ : Trou - Entaille

NOT: Katalogdaki Orijinal Kodlar Referans Amacıyla Kullanılmıştır.Lütfen COTECH Kodlarını Kullanınız.
Original codes used for reference only.Please use COTECH codes for orders.

00



Silindir Kapak

Cylinder Head

01



Zylinderkopf

02



Joint de culasse

03



04



Ltr	MODEL	PS/KW	ENGINE/MOTOR	
3,5 3497	6 CYL ø93 TERRACAN CENTENNIAL XG 350 V6 24 V	07/01-->10/06 06/00-->	195 PS / 143 KW 197 PS / 145 KW	G6CV
				<p>61416005</p> <p>22311-39501 1,20mm FIBER / FIBRE</p> <p>22311-39502 1,20mm FIBER / FIBRE ø94</p>
3,8 3800	6 CYL AZERA V6	2007-->2010		
				<p>61520305</p> <p>ø93,5</p>

▲ : İçerikte Bulunmamaktadır...

▲ : Not included in the set

▲ : Non inclus dans la pochette

00: Motor Takım Keçesiz ve Subap Lastiksiz







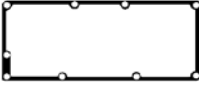
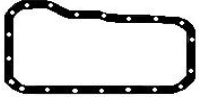

00: Gasket Set Without oil seals Without Valve Stem Seal

01: Motor Takım Keçesiz - Subap Lastikli

01: Gasket set With Valve Stem Seal Without Oil Seals

02: Motor Full Takım Keçeli ve Subap Lastikli

02: Gasket Full Set With oil seals and Valve Stem Seals

<p>Subap Kapak Valve Cover Gasket Zylinderkopfhaube Couvre-culbut.</p> 	<p>Karter Oil Pan Ölwanne Carter d'huile</p> 	<p>Emme Manifold Intake Manifold Ansaug Admission</p> 	<p>Egzoz Manifold Exhaust Manifold Auspuffkrümmer Collecteur D'echappement</p> 	<p>Eksoz Boğaz Exhaust Pipe Auspuff Kehle</p> 	<p>Supap Keçesi Valve Stem Seal Ventilschaft Queue de soupape</p> 	  

■ : Delik - Çentik

■ : Hole - Notch

■ : Trou - Entaille

NOT: Katalogdaki Orijinal Kodlar Referans Amacıyla Kullanılmıştır.Lütfen COTECH Kodlarını Kullanınız.
Original codes used for reference only.Please use COTECH codes for orders.

00



01



02



03



04



Silindir Kapak
Cylinder Head
Zylinderkopf
Joint de culasse

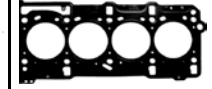

Ltr	MODEL	PS/KW	ENGINE/MOTOR		
2,5 2499	4 CYL ø93 DAILY I 01/89--> 06/90-->	75 PS / 55 KW 72 PS / 53 KW 106 PS / 78 KW 109 PS / 80 KW 116 PS / 85 KW 104 PS / 77 KW 103 PS / 72 KW 98 PS / 68 KW	8140.07.2700 8140.07.2701 8140.07.2710 8140.07.2711 8140.07.2712 8140.07.2713 8140.07.3710 8140.07.3711 8140.07.3712 8140.07.3713 8140.21.200 8140.21.212 8140.27S.2801 8140.27S.2811 8140.27S.2885 8140.27S.3811 8140.27.215 8140.27.218		 60138005 98448817 1,50mm 60138006 99461499 1,40mm ø95
2,5 2499	4 CYL ø93 DAILY II 01/89-->08/98	82 PS / 60 KW	8140.67F.3700 8140.67F.3701 8140.67F.3710 8140.67F.3711 8140.67F.3713		 60147005 98498291 1,80mm 60147006 98492581 1,70mm ø95,2
2,8 2799	4 CYL ø94,4 DAILY I DAILY II 05/96-->05/99	122 PS / 90 KW	8140.23.3700 8140.23.3701 8140.23.3710 8140.23.3711 8140.23.3713 8140.23.3720 8140.23.3721 8140.23.3730 8140.23.3731 8140.23.3750 8140.23.3751 8140.23.3760 8140.43	60139000 99477116 	 60139005 99458402 1,50mm 60139006 99460983 1,40mm 60139007 99432353 1,30mm ø96

▲ : İçerikte Bulunmamaktadır...

▲ : Not included in the set

▲ : Non inclus dans la pochette

00: Motor Takım Keçesiz ve Subap Lastiksiz











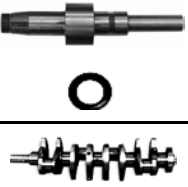
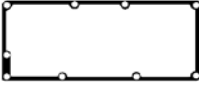

00: Gasket Set Without oil seals Without Valve Stem Seal

01: Motor Takım Keçesiz - Subap Lastikli

01: Gasket set With Valve Stem Seal Without Oil Seals

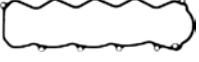
02: Motor Full Takım Keçeli ve Subap Lastikli

02: Gasket Full Set With oil seals and Valve Stem Seals

Subap Kapak Valve Cover Gasket Zylinderkopfhaube Couverculbut.	Karter Oil Pan Ölwanne Carter d'huile	Emme Manifold Intake Manifold Ansaug Admission	Egzoz Manifold Exhaust Manifold Auspuffkrümmer Collecteur D'echappement	Eksoz Boğaz Exhaust Pipe Auspuff Kehle	Supap Keçesi Valve Stem Seal Ventilschaft Queue de soupape	
						
 <p>60138045 500388382</p>  <p>60138047 500388381</p>	 <p>60146066 7301683</p>  <p>60138068 500327440</p>	 <p>60146019x4 98425767</p>	 <p>60147021x4 98434020</p>			

■ : Delik - Çentik

■ : Hole - Notch

■ : Trou - Entaille

NOT: Katalogdaki Orijinal Kodlar Referans Amacıyla Kullanılmıştır.Lütfen COTECH Kodlarını Kullanınız.
Original codes used for reference only.Please use COTECH codes for orders.

00



Silindir Kapak
Cylinder Head
Zylinderkopf
Joint de culasse

01



02



03



04



Ltr	MODEL	PS/KW	ENGINE/MOTOR		
2,8 2799	4 CYL ø94,4 DAILY II 05/96-->05/99	103 PS / 76 KW	8140.23.3801 8140.23.3811 8140.23.3821 8140.43B.4300 8140.43B... 8140.43K... 8140.43N... 8140.43N... 8140.43R... 8140.43S...		 60139005 99458402 1,50mm 60139006 99460983 1,40mm 60139007 99432353 1,30mm ø96
2,8 2799	4 CYL ø94,4 DAILY III 05/99-->	105 PS / 77 KW	8140.43C.4000 8140.43C.4005 8140.43C.4020 8140.43C.4021 8140.43C.4025 8140.43C.4026 8140.43C.4030 8140.43C.4031 8140.43C.4035 8140.43C.4036	60139100 500366511 	 60139005 99458402 1,50mm 60139006 99460983 1,40mm 60139007 99432353 1,30mm ø96
2,8 2799	4 CYL ø94,4 DAILY II DAILY III 09/98-->05/99	84 PS / 62 KW	8140.63.4000 8140.63.4020 8140.63.3711 8140.63.3713 8140.63.3721 8140.63.3723		 60147105 500306172 1,80mm 60147106 500306171 1,70mm 60147107 500306170 1,60mm ø96

▲ : İçerikte Bulunmamaktadır...

▲ : Not included in the set

▲ : Non inclus dans la pochette

00: Motor Takım Keçesiz ve Subap Lastiksiz









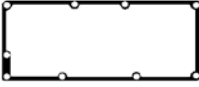

00: Gasket Set Without oil seals Without Valve Stem Seal

01: Motor Takım Keçesiz - Subap Lastikli

01: Gasket set With Valve Stem Seal Without Oil Seals

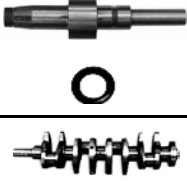
02: Motor Full Takım Keçeli ve Subap Lastikli

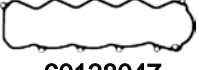
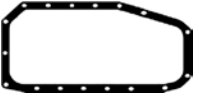
02: Gasket Full Set With oil seals and Valve Stem Seals

<p>Subap Kapak Valve Cover Gasket Zylinderkopfhaube Couvre-culbut.</p> 	<p>Karter Oil Pan Ölwanne Carter d'huile</p> 	<p>Emme Manifold Intake Manifold Ansaug Admission</p> 	<p>Egzoz Manifold Exhaust Manifold Auspuffkrümmer Collecteur D'echappement</p> 	<p>Eksoz Boğaz Exhaust Pipe Auspuff Kehle</p> 	<p>Supap Keçesi Valve Stem Seal Ventilschaft Queue de soupape</p> 	
 <p>60138045 500388382</p>  <p>60138047 500388381</p>	 <p>60138068 98446492</p>	 <p>60146019x4 98425767</p>	 <p>60147021x4 98434020</p>			

■ : Delik - Çentik

■ : Hole - Notch

■ : Trou - Entaille

NOT: Katalogdaki Orijinal Kodlar Referans Amacıyla Kullanılmıştır.Lütfen COTECH Kodlarını Kullanınız.
Original codes used for reference only.Please use COTECH codes for orders.

00



Silindir Kapak
Cylinder Head
Zylinderkopf
Joint de culasse

01



02



03



04

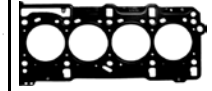

Ltr	MODEL	PS/KW	ENGINE/MOTOR		
	3 CYL ø110 400 500				<p>61316005 8823404 ø114</p>
4,2 4156	4 CYL ø105 LEONCINO 1960-->1969		C01D		<p>61315005 8804253 ø109</p>
4,6 4561	4 CYL ø110 65NC-OM65- 1972-> 75NC-OM75 1973-> 70NC-OM70 1973-> OM50-OM55 1973->1978 329 A BUS 1973->1986 CERBIATTO 1969-> DAINO 1969-> LEONCINO 1969-> LUPETTO 1969->		C03 C03 C03 C03 C03 C03 C03 C03 C03 C03		<p>61411005 8818558 ø114</p>
5,0 4941	TIGROTTO 1969-> LEONCINO 1969-> LUPETTO 1969->		C03 C03 C03		
4,0 4397	4 CYL ø108 / 110 CERBIATTO 1962->1969		C02D		<p>61314005 8807696 ø112</p>
5,0	DAINO 1962->1969		C03D		
4941	LEONCINO 1962->1969 TIGROTTO 1962->1969		C02D C03D		
11,6 11548	6 CYL ø130 300 BUS 1968-> 306 BUS 1968-> 682 N3/T3 1962->1976 682 N4/T4 1968->		203H61 203H61 203A/61 203A/61		<p>61318006 4868477 ø134</p>

▲ : İçerikte Bulunmamaktadır...

▲ : Not included in the set

▲ : Non inclus dans la pochette

00: Motor Takım Keçesiz ve Subap Lastiksiz





00: Gasket Set Without oil seals Without Valve Stem Seal

01: Motor Takım Keçesiz - Subap Lastikli

01: Gasket set With Valve Stem Seal Without Oil Seals

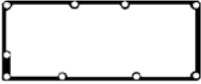
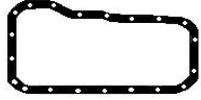
02: Motor Full Takım Keçeli ve Subap Lastikli

02: Gasket Full Set With oil seals and Valve Stem Seals

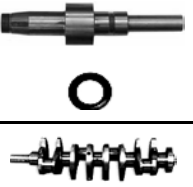
<p>Subap Kapak Valve Cover Gasket Zylinderkopfhaube Couvre-culbut.</p> 	<p>Karter Oil Pan Ölwanne Carter d'huile</p> 	<p>Emme Manifold Intake Manifold Ansaug Admission</p> 	<p>Egzoz Manifold Exhaust Manifold Auspuffkrümmer Collecteur D'echappement</p> 	<p>Eksoz Boğaz Exhaust Pipe Auspuff Kehle</p> 	<p>Supap Keçesi Valve Stem Seal Ventilschaft Queue de soupape</p> 	

 : Delik - Çentik

 : Hole - Notch

 : Trou - Entaille

00



01



02



03



04



Silindir Kapak
Cylinder Head
Zylinderkopf
Joint de culasse



Ltr	MODEL	PS/KW	ENGINE/MOTOR		
2,5 2490	3 CYL ø98 1020			61000900 RE-13255 RE-501574	 61000905 R-98460 R-52790 ø115
2,6 2697	3 CYL ø102 1030 1035 1520			61000903 AR102295	
2,9 2938	3 CYL ø106,5 1630 1635 330				
2,5 2490	3 CYL ø98 1020 JD300 JD301 JD350 JD820 JD830		3152 D	61001000 RE-16912	 61001005 R-98460 R-52790 ø119
2,6 2697	3 CYL ø102 1030 1035 1520 1530 204 JD302		3164 D	61001000 RE-16912	 61001005 R-98460 R-52790 ø119
2,9 2938	3 CYL ø106,5 1630 1635 1040 1140 330 2040 2240 5105 5200 5300		3179 D 3029 D 3029 D 3029 T	61001000 RE-16912	 61001005 R-98460 R-52790 ø119
3,3 3310	4 CYL ø98 2020	4202DL01		62434000 AR-103456 RE-38558	 62434005 R-52790 R-98461 ø115
				62434003 RE-38847	

▲ : İçerikte Bulunmamaktadır...

▲ : Not included in the set

▲ : Non inclus dans la pochette

00: Motor Takım Keçesiz ve Subap Lastiksiz











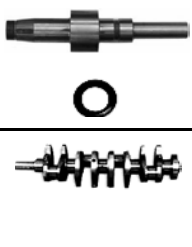
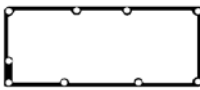







00: Gasket Set Without oil seals Without Valve Stem Seal

01: Motor Takım Keçesiz - Subap Lastikli

01: Gasket set With Valve Stem Seal Without Oil Seals

02: Motor Full Takım Keçeli ve Subap Lastikli

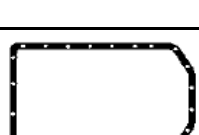
02: Gasket Full Set With oil seals and Valve Stem Seals

Subap Kapak Valve Cover Gasket Zylinderkopfhaube Couvre-culbut.	Karter Oil Pan Ölwanne Carter d'huile	Emme Manifold Intake Manifold Ansaug Admission	Egzoz Manifold Exhaust Manifold Auspuffkrümmer Collecteur D'echappement	Eksoz Boğaz Exhaust Pipe Auspuff Kehle	Supap Keçesi Valve Stem Seal Ventilschaft Queue de soupape	
						
61001058 R-75729 T-20111	61001010 T-24534		61001020x3 T-20006			
						
61001058 R-75729	61001010 T-24534		61001020x3 T-20006			
						
61001058 R-75729	61001010 T-24534		61001020x3 T-20006			
						
61001058 R-75729	61001010 T-24534		61001020x3 T-20006			
						
61002033 T-20075 R-73521	61002008 R-49515 R-123353		61001020x4 T-20006			

■ : Delik - Çentik

■ : Hole - Notch

■ : Trou - Entaille

NOT: Katalogdaki Orijinal Kodlar Referans Amacıyla Kullanılmıştır.Lütfen COTECH Kodlarını Kullanınız.
Original codes used for reference only.Please use COTECH codes for orders.

00



01



02



03



04



Silindir Kapak
Cylinder Head
Zylinderkopf
Joint de culasse

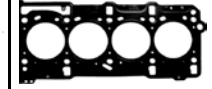

Ltr	MODEL	PS/KW	ENGINE/MOTOR		
3,3 3310	4 CYL ø98 2020 2510 JD400 JD440 JD450 JD480		4202DL01/4180	61002000 AR-71998 RE-38857 61002003 AR-71992 RE-38851	 61002005 R-92425 R-56573 ø119
3,5 3590	4 CYL ø102 2120 2030 2035		4219 D	62434000 AR-103456 RE-38558 62434003 RE-38847	 62434005 R-52790 R-98461 ø115
3,5 3310	4 CYL ø102 2120 2030 2035 2270; 2280 2340; 2420 JD310; JD401		4219 D	61002000 AR-71998 RE-38857 61002003 AR-71992 RE-38851	 61002005 R-92425 R-56573 ø119
3,9 3918	4 CYL ø106,5 2130 2135 935			62434000 AR-103456 RE-38558 62434003 RE-38847	 62434005 R-52790 R-98461 ø115
3,9 3918	4 CYL ø106,5 2130; 2135 1640; 1840; 2040 2140; 2650 2850; 2250; 2450 935; 940 JD4400; JD540B JD550; JD555		4239 D 4239 T	61002000 AR-71998 RE-38857 61002003 AR-71992 RE-38851	 61002005 R-92425 R-56573 ø119

▲ : İçerikte Bulunmamaktadır...

▲ : Not included in the set

▲ : Non inclus dans la pochette

00: Motor Takım Keçesiz ve Subap Lastiksiz











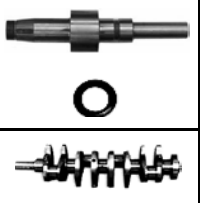
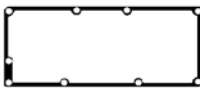







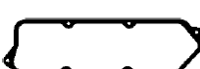

00: Gasket Set Without oil seals Without Valve Stem Seal

01: Motor Takım Keçesiz - Subap Lastikli

01: Gasket set With Valve Stem Seal Without Oil Seals

02: Motor Full Takım Keçeli ve Subap Lastikli

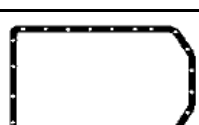
02: Gasket Full Set With oil seals and Valve Stem Seals

Subap Kapak Valve Cover Gasket Zylinderkopfhaube Couvre-culbut.	Karter Oil Pan Ölwanne Carter d'huile	Emme Manifold Intake Manifold Ansaug Admission	Egzoz Manifold Exhaust Manifold Auspuffkrümmer Collecteur D'echappement	Eksoz Boğaz Exhaust Pipe Auspuff Kehle	Supap Keçesi Valve Stem Seal Ventilschaft Queue de soupape	
						
 61002033 T-20075 R-73521	 61002008 R-49515 R-123353		 61001020x4 T-20006			
 61002033 T-20075 R-73521	 61002008 R-49515 R-123353		 61001020x4 T-20006			
 61002033 T-20075 R-73521	 61002008 R-49515 R-123353		 61001020x4 T-20006			
 61002033 T-20075 R-73521	 61002008 R-49515 R-123353		 61001020x4 T-20006			
 61002033 T-20075 R-73521	 61002008 R-49515 R-123353		 61001020x4 T-20006			

 : Delik - Çentik

 : Hole - Notch

 : Trou - Entaille

NOT: Katalogdaki Orijinal Kodlar Referans Amacıyla Kullanılmıştır. Lütfen COTECH Kodlarını Kullanınız.
Original codes used for reference only. Please use COTECH codes for orders.

00



Silindir Kapak
Cylinder Head
Zylinderkopf
Joint de culasse

01



02



03



04

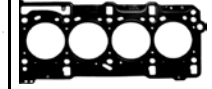

Ltr	MODEL	PS/KW	ENGINE/MOTOR		
3,7	4 CYL ø101,6 JD500 3010 JD510 3020 4 CYL ø101,8 JD500A JD500B JD500C JD510		3010 3010 3020 3020 227/4270D 227/4270D 227/4270D 227/4270D	62433400 AR-53033 62433403 AR-53032	 62433405 R-45616 ø122,5
3,7	4 CYL ø101,6 JD510 3020		3020	62433300 AR-53035 62433303 AR-53034	 62433305 R-48292 ø124,5

▲ : İçerikte Bulunmamaktadır...

▲ : Not included in the set

▲ : Non inclus dans la pochette

00: Motor Takım Keçesiz ve Subap Lastiksiz











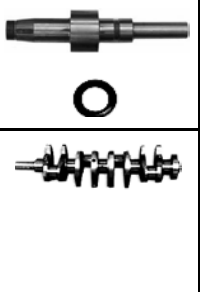
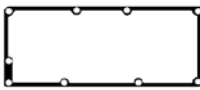

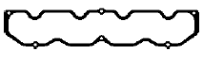
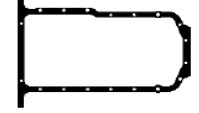

00: Gasket Set Without oil seals Without Valve Stem Seal

01: Motor Takım Keçesiz - Subap Lastikli

01: Gasket set With Valve Stem Seal Without Oil Seals

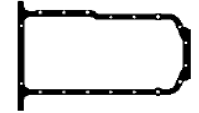
02: Motor Full Takım Keçeli ve Subap Lastikli

02: Gasket Full Set With oil seals and Valve Stem Seals

Subap Kapak Valve Cover Gasket Zylinderkopfhaube Couvre-culbut.	Karter Oil Pan Ölwanne Carter d'huile	Emme Manifold Intake Manifold Ansaug Admission	Egzoz Manifold Exhaust Manifold Auspuffkrümmer Collecteur D'echappement	Eksoz Boğaz Exhaust Pipe Auspuff Kehle	Supap Keçesi Valve Stem Seal Ventilschaft Queue de soupape	
						
 62433334 R-49865	 62433308 R-71917	 62433718x2 R-26297	 62432122x2 R-83020  62432121x2 R-83021			
 62433334 R-49865	 62433308 R-71917	 62433718x2 R-26297	 62432122x2 R-83020  62432121x2 R-83021			

■ : Delik - Çentik

■ : Hole - Notch

■ : Trou - Entaille

NOT: Katalogdaki Orijinal Kodlar Referans Amacıyla Kullanılmıştır.Lütfen COTECH Kodlarını Kullanınız.
Original codes used for reference only.Please use COTECH codes for orders.

00



Silindir Kapak
Cylinder Head
Zylinderkopf
Joint de culasse

01



02



03



04

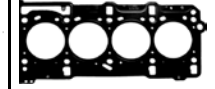

Ltr	MODEL	PS/KW	ENGINE/MOTOR		
4,5 4500	4 CYL ø106 280 310G 340D 344E 410C 410D 440C 450 450H 550 H 650 H 2630 - 2640 - 5410 5420 N 5420 5510 N 5510 - 5520 - 6010 5520 N 6020 6110 6120 6205 6210 6220 6310 6400 6405 6410 6415 6505 6510 6700		4045 D 4045 T 4045 H 4045 HL 4045 TF	62432000 RE-501455 62432003 RE-660282	 62432005 R-116515 ø119
5,4 5395	6 CYL ø102 3120; 3130; 3135 2840;630; 730; 950 960; 970 JD303; JD444; JD540 JD544; JD570; JD482 484; 499; 699 4420; 6600		6329 D	62432600 RE-527022 61003003 AR-71994 RE-38852	 61003005 R-59449 ø119

▲ : İçerikte Bulunmamaktadır...

▲ : Not included in the set

▲ : Non inclus dans la pochette

00: Motor Takım Keçesiz ve Subap Lastiksiz











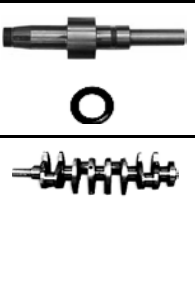
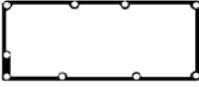
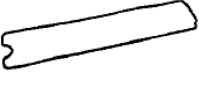

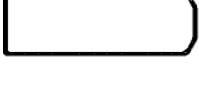

00: Gasket Set Without oil seals Without Valve Stem Seal

01: Motor Takım Keçesiz - Subap Lastikli

01: Gasket set With Valve Stem Seal Without Oil Seals

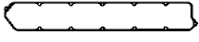
02: Motor Full Takım Keçeli ve Subap Lastikli

02: Gasket Full Set With oil seals and Valve Stem Seals

Subap Kapak Valve Cover Gasket Zylinderkopfhaube Couverculbut.	Karter Oil Pan Ölwanne Carter d'huile	Emme Manifold Intake Manifold Ansaug Admission	Egzoz Manifold Exhaust Manifold Auspuffkrümmer Collecteur D'echappement	Eksoz Boğaz Exhaust Pipe Auspuff Kehle	Supap Keçesi Valve Stem Seal Ventilschaft Queue de soupape	
  62432025 R-123542	  61002008 R-49515 R-123353  62432008 R-123352			  61003017 R-55509 R-89879  62432821x4 R-521439		
 61003033 T-20467 R-75728	 61003008 T-20205 R-97349	 61001088x2 T-20159	 61001020x6 T-20006  61003017 R-55509 R-89879			

■ : Delik - Çentik

■ : Hole - Notch

■ : Trou - Entaille

NOT: Katalogdaki Orijinal Kodlar Referans Amacıyla Kullanılmıştır.Lütfen COTECH Kodlarını Kullanınız.
 Original codes used for reference only.Please use COTECH codes for orders.

00



01



02



03



04



Silindir Kapak
Cylinder Head
Zylinderkopf
Joint de culasse

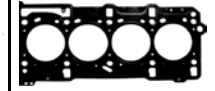

Ltr	MODEL	PS/KW	ENGINE/MOTOR		
5,4 5395	6 CYL ø102 3120 3130 3135 630 730 950 960; 970			61002900 Motor Takım Conta Gasket Set 61002903 Motor Üst Takım Gasket Head Set	 61002905 R-52791 ø115
5,4 5395	6 CYL ø102 955 4240 4440 4040 965 955H 985 1065 1068H 4040S 4240S		3029 D 3029 T 6359 D 6359 T	61003000 AR-74367 AR-102268 AR-97786 61003003 RE-38852 AR-71994	 61003005 R-59449 ø119
5,9 5880	6 CYL ø106,5 3140; 3040 3640; 4040 960; 970; 975 2940; 3050 3350; 3650 JD544B; JD640; JD655 JD670; JD672; JD750 JD755		6359 D 6414 D	62432600 RE-527022 61003003 AR-71994 RE-38852	 61003005 R-59449 ø119
6,6 6600	6 CYL ø101,6 JD600 4010 6 CYL ø104,7 JD600 4020 6 CYL ø108 7700; 7720; JD644 341; 362; 6620; 6622 << 214999		4010/301 4010 381 4020 6404 6404	62424100 AR-53626 62434103 AR-53625	 62434105 R-45615 ø122,5

▲ : İçerikte Bulunmamaktadır...

▲ : Not included in the set

▲ : Non inclus dans la pochette

00: Motor Takım Keçesiz ve Subap Lastiksiz











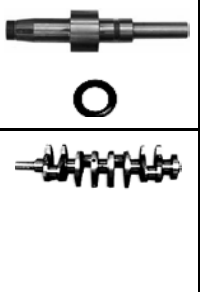
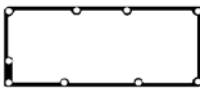





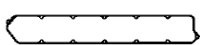



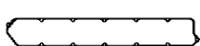

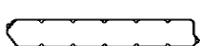

00: Gasket Set Without oil seals Without Valve Stem Seal

01: Motor Takım Keçesiz - Subap Lastikli

01: Gasket set With Valve Stem Seal Without Oil Seals

02: Motor Full Takım Keçeli ve Subap Lastikli

02: Gasket Full Set With oil seals and Valve Stem Seals

Subap Kapak Valve Cover Gasket Zylinderkopfhaube Couvre-culbut.	Karter Oil Pan Ölwanne Carter d'huile	Emme Manifold Intake Manifold Ansaug Admission	Egzoz Manifold Exhaust Manifold Auspuffkrümmer Collecteur D'échappement	Eksoz Boğaz Exhaust Pipe Auspuff Kehle	Supap Keçesi Valve Stem Seal Ventilschaft Queue de soupape	
						
 61003033 T-20467 R-75728	 61003008 T-20205 R-97349	 61001088x2 T-20159	 61001020x6 T-20006  61003017 R-55509 R-89879			
 61003033 T-20467 R-75728	 61003008 T-20205 R-97349	 61001088x2 T-20159	 61001020x6 T-20006  61003017 R-55509 R-89879			
 61003033 T-20467 R-75728	 61003008 T-20205 R-97349	 61001088x2 T-20159	 61001020x6 T-20006  61003017 R-55509 R-89879			
 62432134 R-49866	 62432108 R-71918 R-520583	 62433718x3 R-26297	 62432122x2 R-83020  62432121x2 R-83021			

 : Delik - Çentik

 : Hole - Notch

 : Trou - Entaille

NOT: Katalogdaki Orijinal Kodlar Referans Amacıyla Kullanılmıştır. Lütfen COTECH Kodlarını Kullanınız.
Original codes used for reference only. Please use COTECH codes for orders.

00



Silindir Kapak
Cylinder Head
Zylinderkopf
Joint de culasse

01



02



03



04

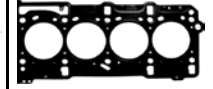

Ltr	MODEL	PS/KW	ENGINE/MOTOR		
6,6 6600	6 CYL ø101,6 JD600 4010 6 CYL ø104,7 JD600 4020 6 CYL ø108 7700; 7720; JD644 341; 362; 6620; 6622 >>215000-335845		4010/301 4010 381 4020 6404 6404	62433600 AR-53631 62433603 AR-53630	 62432105 R-48291 ø124,5
6,6 6600	6 CYL ø108 4520 JD690B; JD693B JD740 ; 4040; 4249 4440; 5440 5640; 7020 7720; 4430 4620; 4630; 4320		4520/6404A/D/T	62432100 RG-27875 62432103 RG-27876 AR-63270	 62432105 R-48291 ø124,5

▲ : İçerikte Bulunmamaktadır...

▲ : Not included in the set

▲ : Non inclus dans la pochette

00: Motor Takım Keçesiz ve Subap Lastiksiz











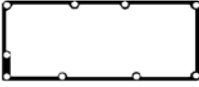

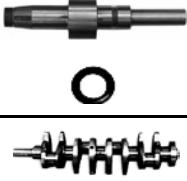
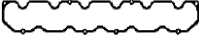

00: Gasket Set Without oil seals Without Valve Stem Seal

01: Motor Takım Keçesiz - Subap Lastikli

01: Gasket set With Valve Stem Seal Without Oil Seals

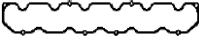
02: Motor Full Takım Keçeli ve Subap Lastikli

02: Gasket Full Set With oil seals and Valve Stem Seals

<p>Subap Kapak Valve Cover Gasket Zylinderkopfhaube Couvre-culbut.</p> 	<p>Karter Oil Pan Ölwanne Carter d'huile</p> 	<p>Emme Manifold Intake Manifold Ansaug Admission</p> 	<p>Egzoz Manifold Exhaust Manifold Auspuffkrümmer Collecteur D'echappement</p> 	<p>Eksoz Boğaz Exhaust Pipe Auspuff Kehle</p> 	<p>Supap Keçesi Valve Stem Seal Ventilschaft Queue de soupape</p> 	
 <p>62432134 R-49866</p>	 <p>62432108 R-71918 R-520583</p>	 <p>62433718x3 R-26297</p>	 <p>62432122x2 R-83020</p>  <p>62432121x2 R-83021</p>			
 <p>62432134 R-49866</p>	 <p>62432108 R-71918 R-520583</p>	 <p>62433718x3 R-26297</p>	 <p>62432122x2 R-83020</p>  <p>62432121x2 R-83021</p>			

■ : Delik - Çentik

■ : Hole - Notch

■ : Trou - Entaille

NOT: Katalogdaki Orijinal Kodlar Referans Amacıyla Kullanılmıştır.Lütfen COTECH Kodlarını Kullanınız.
Original codes used for reference only.Please use COTECH codes for orders.

00



Silindir Kapak
Cylinder Head
Zylinderkopf
Joint de culasse

01



02



03



04

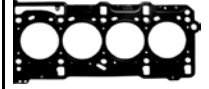

Ltr	MODEL	PS/KW	ENGINE/MOTOR		
6,8	6 CYL ø106				
6800	JD670	Tractor :			
	JD755	6215 / 6320 / 6420	6068 H	62432200	
	LX100-2	6510 / 6515 / 6520	6068 T	RE-501456	
	42.14	6605 / 6610 / 6615			
	360DC	6715 / 6810 / 6820		62432203	
	360DG	6910S / 6920 / 6920S		RE-66083	
	430B	7220 / 7320 / 7400			
	460DC	7420 / 7510 / 7520			
	460DG	7610 / 7710 / 7810			
	540G	6505 / 6603 / 6620			
	544J	6910 / 7210 / 7410 / 7600			
	548G				
	624EH				
	624G				
	640E				
	640G				
	648G				
	653E				
	653G				
	690				
	700H				
	700J				
	710D				
	710J				
	750C				
	750J				
	790E				
	850J				
	1070D				
	1110D				
	1410D				
	1450				
	1490D				
	1550				
	2054				
	2054				
	2254				
	2254				
	4710				
	4990				
	4995				
	7455				
	7460				
	9400				
	9410				
	9540				
	9560				
	9580				
	9935				



62432205
R-116516
ø119

▲ : İçerikte Bulunmamaktadır...

▲ : Not included in the set

▲ : Non inclus dans la pochette

00: Motor Takım Keçesiz ve Subap Lastiksiz







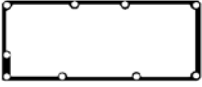
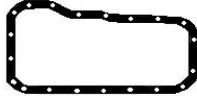

00: Gasket Set Without oil seals Without Valve Stem Seal

01: Motor Takım Keçesiz - Subap Lastikli

01: Gasket set With Valve Stem Seal Without Oil Seals

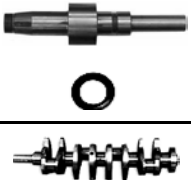
02: Motor Full Takım Keçeli ve Subap Lastikli

02: Gasket Full Set With oil seals and Valve Stem Seals

<p>Subap Kapak Valve Cover Gasket Zylinderkopfhaube Couvre-culbut.</p> 	<p>Karter Oil Pan Ölwanne Carter d'huile</p> 	<p>Emme Manifold Intake Manifold Ansaug Admission</p> 	<p>Egzoz Manifold Exhaust Manifold Auspuffkrümmer Collecteur D'echappement</p> 	<p>Eksoz Boğaz Exhaust Pipe Auspuff Kehle</p> 	<p>Supap Keçesi Valve Stem Seal Ventilschaft Queue de soupape</p> 	
 <p>62432225 R-123543</p>	 <p>61003008 T-20205 R-123354</p>		 <p>61003017 R-55509 R-89879</p>  <p>62432821x6 R-521439</p>			

■ : Delik - Çentik

■ : Hole - Notch

■ : Trou - Entaille

NOT: Katalogdaki Orijinal Kodlar Referans Amacıyla Kullanılmıştır.Lütfen COTECH Kodlarını Kullanınız.
Original codes used for reference only.Please use COTECH codes for orders.

00



01



02



03



04



Silindir Kapak
Cylinder Head
Zylinderkopf
Joint de culasse

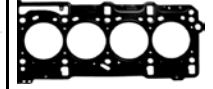

Ltr MODEL PS/KW ENGINE/MOTOR

Ltr	MODEL	PS/KW	ENGINE/MOTOR		
7,6	6 CYL ø116				
7600	220LC		6076	62433700	
	540E		6076 A	RE-524624	
	548E		6076 H	AR-101276	62433705
	548G		6076 T		RE-47336
	640E			62433703	R-66065
	640G			RE-526730	ø129
	648E			RG-27884	
	648G				
	740E				
	740G				
	748G				
	1185				
	2440				
	4255				
	4455				
	4555				
	4560				
	4755				
	4760				
	4955				
	4960				
	6076-AG				
	7700				
	7700				
	7800				
	8100				
	8200				
	8300				
	8560				
	8570				
	9500				
	9600				
	9960				
	9965				

▲ : İçerikte Bulunmamaktadır...

▲ : Not included in the set

▲ : Non inclus dans la pochette

00: Motor Takım Keçesiz ve Subap Lastiksiz











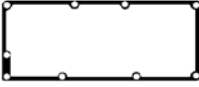

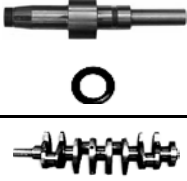
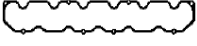

00: Gasket Set Without oil seals Without Valve Stem Seal

01: Motor Takım Keçesiz - Subap Lastikli

01: Gasket set With Valve Stem Seal Without Oil Seals

02: Motor Full Takım Keçeli ve Subap Lastikli

02: Gasket Full Set With oil seals and Valve Stem Seals

<p>Subap Kapak Valve Cover Gasket Zylinderkopfhaube Couvre-culbut.</p> 	<p>Karter Oil Pan Ölwanne Carter d'huile</p> 	<p>Emme Manifold Intake Manifold Ansaug Admission</p> 	<p>Egzoz Manifold Exhaust Manifold Auspuffkrümmer Collecteur D'echappement</p> 	<p>Eksoz Boğaz Exhaust Pipe Auspuff Kehle</p> 	<p>Supap Keçesi Valve Stem Seal Ventilschaft Queue de soupape</p> 	
 <p>62432134 R-49866</p>	 <p>62432108 R-71918 R-520583</p>  <p>62432109 R-49377 R-521228</p>	 <p>62433819x3 R-130573</p>	 <p>62432122x2 R-83020</p>  <p>62432121x2 R-83021</p>	 <p>61003017 R-55509 R-89879</p>  <p>62432518 R-92097 R-123583</p>		

■ : Delik - Çentik

■ : Hole - Notch

■ : Trou - Entaille

NOT: Katalogdaki Orijinal Kodlar Referans Amacıyla Kullanılmıştır.Lütfen COTECH Kodlarını Kullanınız.
Original codes used for reference only.Please use COTECH codes for orders.

00



Silindir Kapak
Cylinder Head
Zylinderkopf
Joint de culasse

01



02



03



04



Ltr	MODEL	PS/KW	ENGINE/MOTOR		
7,6 7600	6 CYL ø116 Series 500 644C 644D 690 762A 762B 770 770A 770B 4050 4250 4350 4440 4450 4640 4650 4755 4760 4840 4850 4955 4960 5720 5730 6620 6622 7720 8430 8440 8450 8560 8820 9940 9950		6466 A 6466 T	62433800 RE-524404 62433803 RE-524409	 62433705 RE-47336 R-66065 ø129
8,7 8700	6 CYL ø120 JD644B JD646 JD646B Series 770 770A 772A		6531 A 6531 T	62433900 RE-524149 RE-17050 62433903 RE-524148 AR-67510	 62433905 R-78513 ø138

▲ : İçerikte Bulunmamaktadır...

▲ : Not included in the set

▲ : Non inclus dans la pochette

00: Motor Takım Keçesiz ve Subap Lastiksiz











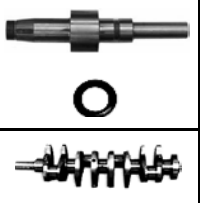
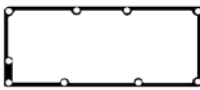

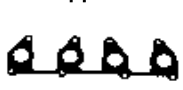

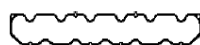

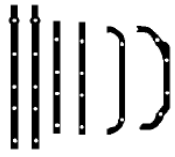

00: Gasket Set Without oil seals Without Valve Stem Seal

01: Motor Takım Keçesiz - Subap Lastikli

01: Gasket set With Valve Stem Seal Without Oil Seals

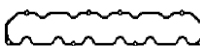
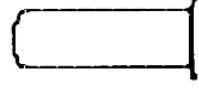
02: Motor Full Takım Keçeli ve Subap Lastikli

02: Gasket Full Set With oil seals and Valve Stem Seals

Subap Kapak Valve Cover Gasket Zylinderkopfhaube Couvre-culbut.	Karter Oil Pan Ölwanne Carter d'huile	Emme Manifold Intake Manifold Ansaug Admission	Egzoz Manifold Exhaust Manifold Auspuffkrümmer Collecteur D'echappement	Eksoz Boğaz Exhaust Pipe Auspuff Kehle	Supap Keçesi Valve Stem Seal Ventilschaft Queue de soupape	
						
 62432134 R-49866	 62432108 R-71918 R-520583  62432109 R-49377 R-521228	 62433819x3 R-130573  62432118x3 R-50397	 62432122x2 R-83020  62432121x2 R-83021  62432143 R-43751	 61003017 R-55509 R-89879  62432518 R-92097 R-123583		
 62433934 R-47365 R-49867	 62433908 R-56325 R-520584	 62433517x3 R-520521 R-40088	 R-80969x2  R-80970x2 62433521x2 R-80970 + R-80969	 61003017 R-55509 R-89879		

 : Delik - Çentik

 : Hole - Notch

 : Trou - Entaille

NOT: Katalogdaki Orijinal Kodlar Referans Amacıyla Kullanılmıştır.Lütfen COTECH Kodlarını Kullanınız.
Original codes used for reference only.Please use COTECH codes for orders.

00



01



02



03



04



Silindir Kapak
Cylinder Head
Zylinderkopf
Joint de culasse



Ltr	MODEL	PS/KW	ENGINE/MOTOR		
8,1	6 CYL ø116				
8100	330CR		6081 T	62432700	
	330LC		6081 H	RE-527579	
	370			RE-506220	
	530B			62432703	62432705
	560D			RE-527550	RE-55475
	608			RE-506222	ø129
	644				
	660D				
	724J				
	740G				
	742J				
	753G				
	762				
	770D				
	850C				
	850J				
	870D				
	2256				
	2258				
	2266				
	6650				
	6710				
	7710				
	7810				
	7820				
	7920				
	8100				
	8110				
	8120				
	8200				
	8210				
	8220				
	8220T				
	8300				
	8310				
	8320				
	8400				
	8420				
	9450				
	9510/SH				
	9550/SH				
	9560				
	9580				
	9610				
	9640				
	9650				
	9650/CTS/STS				
	9660 / 9860 / 9960 / 9970				
	9750 STS				

▲ : İçerikte Bulunmamaktadır...

▲ : Not included in the set

▲ : Non inclus dans la pochette

00: Motor Takım Keçesiz ve Subap Lastiksiz









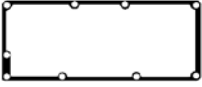
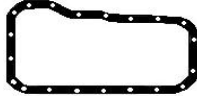

00: Gasket Set Without oil seals Without Valve Stem Seal

01: Motor Takım Keçesiz - Subap Lastikli

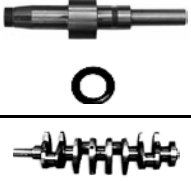
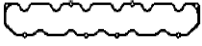
01: Gasket set With Valve Stem Seal Without Oil Seals

02: Motor Full Takım Keçeli ve Subap Lastikli

02: Gasket Full Set With oil seals and Valve Stem Seals

<p>Subap Kapak Valve Cover Gasket Zylinderkopfhaube Couvre-culbut.</p> 	<p>Karter Oil Pan Ölwanne Carter d'huile</p> 	<p>Emme Manifold Intake Manifold Ansaug Admission</p> 	<p>Egzoz Manifold Exhaust Manifold Auspuffkrümmer Collecteur D'echappement</p> 	<p>Eksoz Boğaz Exhaust Pipe Auspuff Kehle</p> 	<p>Supap Keçesi Valve Stem Seal Ventilschaft Queue de soupape</p> 	
 <p>62432134 R-49866</p>	 <p>62432708 R-521228</p>	 <p>62433819x6 R-130573 R-120646</p>	 <p>62432122x2 R-62776</p>  <p>62432121x2 R-83021</p>	 <p>61003017 R-55509 R-89879</p>		

■ : Delik - Çentik

■ : Hole - Notch

■ : Trou - Entaille

NOT: Katalogdaki Orijinal Kodlar Referans Amacıyla Kullanılmıştır.Lütfen COTECH Kodlarını Kullanınız.
Original codes used for reference only.Please use COTECH codes for orders.

KIA

00



Silindir Kapak
Cylinder Head

01



Zylinderkopf

02



Joint de culasse

03



04



Ltr	MODEL	PS/KW	ENGINE/MOTOR		
1,0 999 1,1 1086	4 CYL ø66 PICANTO 12 V 04/04--> PICANTO EPSILON 12 V (SOCH)	65 PS / 48 KW 61 PS / 45 KW	G4HE G4HG		 61410405 22311-02760 1,20mm FIBER / FIBRE ø68
1,3 1323	4 CYL ø71 PRIDE 01/90--> (SOCH)	69 PS / 51 KW	B3		 61410605 B302-10-271 1,60mm 61410606 B302-10-271 2,00mm ø74
1,3 1343	4 CYL ø75,5 RIO 08/00-->02/05 (SOCH)	82 PS / 60 KW 75 PS / 50 KW	B3		 61410105 OK30C 10 271A 1,20mm FIBER / FIBRE ø76,5
1,4 1399	4 CYL ø75,5 RIO 16 V 03/05--> (DOCH)	97 PS / 71 KW	G4EE		 61410505 22311-26603 1,20mm FIBER / FIBRE ø77

▲ : İçerikte Bulunmamaktadır...

▲ : Not included in the set

▲ : Non inclus dans la pochette

00: Motor Takım Keçesiz ve Subap Lastiksiz







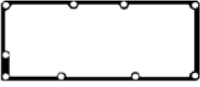

00: Gasket Set Without oil seals Without Valve Stem Seal

01: Motor Takım Keçesiz - Subap Lastikli

01: Gasket set With Valve Stem Seal Without Oil Seals

02: Motor Full Takım Keçeli ve Subap Lastikli

02: Gasket Full Set With oil seals and Valve Stem Seals

<p>Subap Kapak Valve Cover Gasket Zylinderkopfhaube Couvre-culbut.</p> 	<p>Karter Oil Pan Ölwanne Carter d'huile</p> 	<p>Emme Manifold Intake Manifold Ansaug Admission</p> 	<p>Egzoz Manifold Exhaust Manifold Auspuffkrümmer Collecteur D'echappement</p> 	<p>Eksoz Boğaz Exhaust Pipe Auspuff Kehle</p> 	<p>Supap Keçesi Valve Stem Seal Ventilschaft Queue de soupape</p> 	  

■ : Delik - Çentik

■ : Hole - Notch

■ : Trou - Entaille

NOT: Katalogdaki Orijinal Kodlar Referans Amacıyla Kullanılmıştır.Lütfen COTECH Kodlarını Kullanınız.
Original codes used for reference only.Please use COTECH codes for orders.

KIA

00



01



02



03



04



Silindir Kapak
Cylinder Head
Zylinderkopf
Joint de culasse

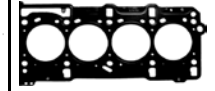

Ltr	MODEL	PS/KW	ENGINE/MOTOR		
1,4 1396	4 CYL ø77mm CEE'D PRO CEE'D 12/06-->08/08	109 PS / 80 KW	G4FA		 61510105 22311-2B000 1,20mm FIBER/ FIBRE ø78,5
1,4 1396	4 CYL ø77mm CEE'D PRO CEE'D 09/08-->	109 PS / 80 KW	G4FA		 61510106 22311-2B003 1,20mm FIBER / FIBRE ø78,5
1,5 1493	4 CYL ø75,5 RIO 16 V (DOCH) 09/02-->02/05	97 PS / 71 KW	A3E B3 16V		 61410205 OK30E1 10 271A 1,20mm FIBER / FIBRE ø76,5
1,5 1498	4 CYL ø78 SEPHIA AVELLA LEO MENTOR (SOCH) 02/96-->10/97	80 PS / 59 KW	B5		 61480205 OB61L10271A 1,30mm ø79,5
1,6 1597	4 CYL ø78 SEPHIA MENTOR SEPHIA 16 V (SOCH) 09/93-->10/97	80 PS / 59 KW	B6		 61480205 OB61L10271A 1,30mm ø79,5
1,6 1599	4 CYL ø76,5 CERATO 16V RIO 16V 02/04-->10/06	105 PS / 77 KW	G4ED		 61410505 22311-26603 1,20mm FIBER / FIBRE ø77

▲ : İçerikte Bulunmamaktadır...

▲ : Not included in the set

▲ : Non inclus dans la pochette

00: Motor Takım Keçesiz ve Subap Lastiksiz







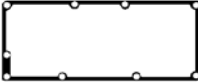

00: Gasket Set Without oil seals Without Valve Stem Seal

01: Motor Takım Keçesiz - Subap Lastikli

01: Gasket set With Valve Stem Seal Without Oil Seals

02: Motor Full Takım Keçeli ve Subap Lastikli

02: Gasket Full Set With oil seals and Valve Stem Seals

Subap Kapak Valve Cover Gasket Zylinderkopfhaube Couvre-culbut. 	Karter Oil Pan Ölwanne Carter d'huile 	Emme Manifold Intake Manifold Ansaug Admission 	Egzoz Manifold Exhaust Manifold Auspuffkrümmer Collecteur D'echappement 	Eksoz Boğaz Exhaust Pipe Auspuff Kehle 	Supap Keçesi Valve Stem Seal Ventilschaft Queue de soupape 	  

 : Delik - Çentik

 : Hole - Notch

 : Trou - Entaille

NOT: Katalogdaki Orijinal Kodlar Referans Amacıyla Kullanılmıştır.Lütfen COTECH Kodlarını Kullanınız.
Original codes used for reference only.Please use COTECH codes for orders.

00



Silindir Kapak
Cylinder Head
Zylinderkopf
Joint de culasse

01



02



03



04

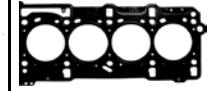

Ltr	MODEL	PS/KW	ENGINE/MOTOR		
1,6 1591	4 CYL ø77mm CEE'D 05/06-->10/08 PRO CEE'D CERATO	122 PS / 90 KW 115 PS / 85 KW 126 PS / 93 KW	G4FC		<p>61510105 22311-2B000 1,20mm FIBER/ FIBRE ø78,5</p>
1,6 1591	4 CYL ø77mm CEE'D 11/08--> PRO CEE'D CERATO SOUL CARENS	122 PS / 90 KW 126 PS / 93 KW 115 PS / 85 KW 132 PS / 97 KW	G4FC		<p>61510106 22311-2B003 1,20mm FIBER / FIBRE ø78,5</p>
2,0 1975	4 CYL ø82 SPECTRA 16V 04/04--> CERATO 16V SPORTAGE 16V CARENS II 16V CEE'D 16 V (DOCH)	143 PS / 105 KW 141 PS / 104 KW 139 PS / 102 KW	G4GC		<p>61418005 22311-23700 1,20mm FIBER / FIBRE ø84</p>
2,0 1997	4 CYL ø85 OPTIMA 16V 05/01--> MAGENTIS 16V	136 PS / 100 KW	G4JP		<p>61510005 22311-38100 1,20mm FIBER / FIBRE ø86</p>
2,0 1998	4 CYL ø86 SPORTAGE 04/94-->08/99 (SOCH)	95 PS / 70 KW	FE (8V)		<p>61420305 F202-10-271 1,40mm</p> <p>61420306 F202-10-271 1,80mm ø87,5</p>

▲ : İçerikte Bulunmamaktadır...

▲ : Not included in the set

▲ : Non inclus dans la pochette

00: Motor Takım Keçesiz ve Subap Lastiksiz







00: Gasket Set Without oil seals Without Valve Stem Seal

01: Motor Takım Keçesiz - Subap Lastikli

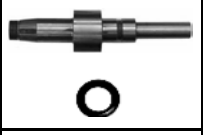
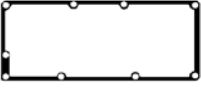
01: Gasket set With Valve Stem Seal Without Oil Seals

02: Motor Full Takım Keçeli ve Subap Lastikli

02: Gasket Full Set With oil seals and Valve Stem Seals

Subap Kapak Valve Cover Gasket Zylinderkopfhaube Couvre-culbut.	Karter Oil Pan Ölwanne Carter d'huile	Emme Manifold Intake Manifold Ansaug Admission	Egzoz Manifold Exhaust Manifold Auspuffkrümmer Collecteur D'echappement	Eksoz Boğaz Exhaust Pipe Auspuff Kehle	Supap Keçesi Valve Stem Seal Ventilschaft Queue de soupape	
						

■ : Delik - Çentik

■ : Hole - Notch

■ : Trou - Entaille

NOT: Katalogdaki Orijinal Kodlar Referans Amacıyla Kullanılmıştır.Lütfen COTECH Kodlarını Kullanınız.
Original codes used for reference only.Please use COTECH codes for orders.

00



01



02



03



04



Silindir Kapak
Cylinder Head
Zylinderkopf
Joint de culasse

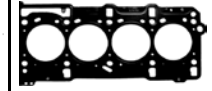

Ltr	MODEL	PS/KW	ENGINE/MOTOR		
2,0 1998	4 CYL ø86 SPORTAGE 16V 04/94--> RETONA 16V CLARUS 16V (DOCH)	133 PS / 98 KW 128 PS / 94 KW	FE		61410305 OK013 10 271 1,20mm FIBER / FIBRE ø87,5
2,2 2184	4 CYL ø86 BESTA D 02/96--> RETONA TD SPORTAGE TD	65 PS / 48 KW 83 PS / 61 KW	R2 RF	61410000 RF01-99-100	61410005 R201-10-271A ø87,5
2,2 2,200	4 CYL ø88,9 CERES 1979-->1981	89 PS / 70 KW	S2	61480000 0527-99-100	61480005 0527-10-271A ø97
2,4 2,400	4 CYL ø92 CERES 1973-->1977	81 PS / 77 KW	XA XB	61480000 0527-99-100	61480005 0527-10-271A ø97
2,5 2476	4 CYL ø91,1 PREGIO K2500 BONGO (SOCH)	94 PS / 69 KW	4DBH	61470002 20910-42E00 	61470005 MD302893 1,60mm 5 61470006 22311-42525 1,55mm 4 61470007 22311-42855 1,50mm 3 61470008 22311-42515 1,45mm 2 ø92,5

▲ : İçerikte Bulunmamaktadır...

▲ : Not included in the set

▲ : Non inclus dans la pochette

00: Motor Takım Keçesiz ve Subap Lastiksiz











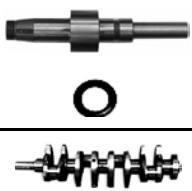
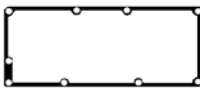











00: Gasket Set Without oil seals Without Valve Stem Seal

01: Motor Takım Keçesiz - Subap Lastikli

01: Gasket set With Valve Stem Seal Without Oil Seals

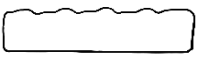
02: Motor Full Takım Keçeli ve Subap Lastikli

02: Gasket Full Set With oil seals and Valve Stem Seals

Subap Kapak Valve Cover Gasket Zylinderkopfhaube Couvre-culbut.	Karter Oil Pan Ölwanne Carter d'huile	Emme Manifold Intake Manifold Ansaug Admission	Egzoz Manifold Exhaust Manifold Auspuffkrümmer Collecteur D'echappement	Eksoz Boğaz Exhaust Pipe Auspuff Kehle	Supap Keçesi Valve Stem Seal Ventilschaft Queue de soupape	
						
 61410025 RF01-10-235	 61410013 F80110-431	 61410019 RF0113-111	 61410020 RF01-13-462			
 61480025 1456-10-235	 61480013 1363-89-104	 61480019x4 0636-13-111	 61480021x4 0750-13-461 0750-13-461A			
 61480025 1456-10-235	 61480013 1363-89-104	 61480019x4 0636-13-111	 61480021x4 0750-13-461 0750-13-461A			
 61450025 MD050312	 61450013 MD149392	 61470021 28520-42070			 61450026x8 8x13x9x13	21201013 35x50x8 RD 21201023 44x60x7 RD 21201035 80x96x9 LD 21201004 25x35x6 21201001 17x28x7

■ : Delik - Çentik

■ : Hole - Notch

■ : Trou - Entaille

NOT: Katalogdaki Orijinal Kodlar Referans Amacıyla Kullanılmıştır.Lütfen COTECH Kodlarını Kullanınız.
Original codes used for reference only.Please use COTECH codes for orders.

KIA

00



Silindir Kapak
Cylinder Head

01



Zylinderkopf

02



Joint de culasse

03



04

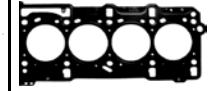

Ltr	MODEL	PS/KW	ENGINE/MOTOR	
2,5 2497	4 CYL ø91 SORENTO CRDI 16V 08/02--> (DOCH)	140 PS / 103 KW	D4CB	
				61415505 22311-4A000 1,40mm FIBER / FIBRE ø92,5
2,7 2665	4 CYL ø94,5 K2700 10/97--> PREGIO BESTA GS BONGO (SOCH)	80 PS / 59 KW 82 PS / 60 KW	J2	
				61411205 OK65A10271B 1,60mm FIBER / FIBRE 61411206 OK65A10271B 2,0mm FIBER / FIBRE ø98,5
2,9 2902	4 CYL ø97,1 SEDONA 16V 10/01--> CARNIVAL TDI 16V CARNIVAL II CRDI 16V	144 PS / 106 KW	KJ	
				61510405 OK56A10271B 1,50mm FIBER / FIBRE ø100,5
2,9 2956	4 CYL ø98 BESTA GS 07/00--> K300 (SOCH)	85 PS / 63 KW	JTA	
				61410905 OK75A10271 1,60mm FIBER / FIBRE 61410906 OK75A10271 2,0mm FIBER / FIBRE ø101

▲ : İçerikte Bulunmamaktadır...

▲ : Not included in the set

▲ : Non inclus dans la pochette

00: Motor Takım Keçesiz ve Subap Lastiksiz







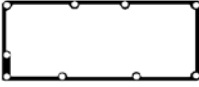
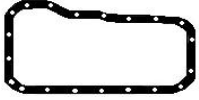

00: Gasket Set Without oil seals Without Valve Stem Seal

01: Motor Takım Keçesiz - Subap Lastikli

01: Gasket set With Valve Stem Seal Without Oil Seals

02: Motor Full Takım Keçeli ve Subap Lastikli

02: Gasket Full Set With oil seals and Valve Stem Seals

<p>Subap Kapak Valve Cover Gasket Zylinderkopfhaube Couvre-culbut.</p> 	<p>Karter Oil Pan Ölwanne Carter d'huile</p> 	<p>Emme Manifold Intake Manifold Ansaug Admission</p> 	<p>Egzoz Manifold Exhaust Manifold Auspuffkrümmer Collecteur D'echappement</p> 	<p>Eksoz Boğaz Exhaust Pipe Auspuff Kehle</p> 	<p>Supap Keçesi Valve Stem Seal Ventilschaft Queue de soupape</p> 	  

■ : Delik - Çentik

■ : Hole - Notch

■ : Trou - Entaille

NOT: Katalogdaki Orijinal Kodlar Referans Amacıyla Kullanılmıştır.Lütfen COTECH Kodlarını Kullanınız.
Original codes used for reference only.Please use COTECH codes for orders.

KIA

00



Silindir Kapak
Cylinder Head
Zylinderkopf
Joint de culasse

01



02



03



04

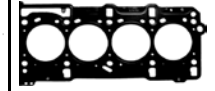

Ltr	MODEL	PS/KW	ENGINE/MOTOR	
3,3 3297	6 CYL ø92 SORENTO I V6 11/07-->	248 PS / 182 KW	G6DB	61510305 22311-3C140 1,50mm FIBER / FIBRE 22311-3C130 1,50mm FIBER / FIBRE ø93,5
3,5 3497	6 CYL ø93 SORENTO V6 11/02--> SEDONA V6 09/03--> OPIRUS V6 AMANTI V6 (DOCH)	203 PS/ 149 KW	6G74 G6CU	61416005 22311-39501 1,20mm FIBER / FIBRE 22311-39502 1,20mm FIBER / FIBRE ø94

▲ : İçerikte Bulunmamaktadır...

▲ : Not included in the set

▲ : Non inclus dans la pochette

00: Motor Takım Keçesiz ve Subap Lastiksiz





00: Gasket Set Without oil seals Without Valve Stem Seal

01: Motor Takım Keçesiz - Subap Lastikli

01: Gasket set With Valve Stem Seal Without Oil Seals

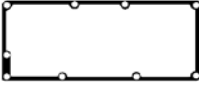
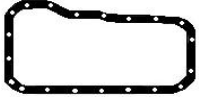
02: Motor Full Takım Keçeli ve Subap Lastikli

02: Gasket Full Set With oil seals and Valve Stem Seals

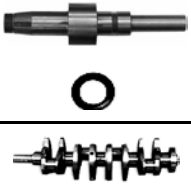
<p>Subap Kapak Valve Cover Gasket Zylinderkopfhaube Couvre-culbut.</p> 	<p>Karter Oil Pan Ölwanne Carter d'huile</p> 	<p>Emme Manifold Intake Manifold Ansaug Admission</p> 	<p>Egzoz Manifold Exhaust Manifold Auspuffkrümmer Collecteur D'echappement</p> 	<p>Eksoz Boğaz Exhaust Pipe Auspuff Kehle</p> 	<p>Supap Keçesi Valve Stem Seal Ventilschaft Queue de soupape</p> 	

■ : Delik - Çentik

■ : Hole - Notch

■ : Trou - Entaille

NOT: Katalogdaki Orijinal Kodlar Referans Amacıyla Kullanılmıştır.Lütfen COTECH Kodlarını Kullanınız.
Original codes used for reference only.Please use COTECH codes for orders.

00



01



02



03



04



Silindir Kapak
Cylinder Head
Zylinderkopf
Joint de culasse



Ltr	MODEL	PS/KW	ENGINE/MOTOR		
1,1 1100	4 CYL ø76 FORMAN SAMARA 02/88-->12/94	53 PS / 39 KW 58 PS / 43 KW	BA3 21081	64021000 2900-4705	<p>64021005 2108-1003020 1,50mm ø78</p>
1,2 1198	4 CYL ø76 VAZ 2101 VAZ 2102 01/70-->06/86	60 PS / 44 KW	BA3 2101 OHC	60311002 2101-100001 60311000 2101-100001	<p>60311005 2101-1003020 1,20mm</p> <p>60311006 2101-1003020 1,80mm ø77,5</p>
1,3 1288	4 CYL ø76 FORMAN SAMARA VAZ 2108 VAZ 2109 VAZ 21086 VAZ 21096 01/86-->12/94	65 PS / 48 KW 61 PS / 45 KW 63 PS / 46 KW	BA3 2108 OHC	64021000 2900-4705	<p>64021005 2108-1003020 1,50mm ø78</p>
1,3 1294	4 CYL ø79 VAZ 21011 VAZ 21033 08/74-->08/84	69 PS / 51 KW	OHC	64016002 42602555 64016000 42602555	<p>64016005 21011-13020 1,20mm</p> <p>64016006 21011-13020 1,80mm ø82</p>
1,3 1294	4 CYL ø79 VAZ 2105 VAZ 2104 05/81-->	65 PS / 48 KW	BA3 2105	64013002 46602556 64013000 46602556	<p>64013005 1,20mm 2105-1003020</p> <p>64013006 2105-1003020 1,80mm ø81</p>

▲ : İçerikte Bulunmamaktadır...

▲ : Not included in the set

▲ : Non inclus dans la pochette

00: Motor Takım Keçesiz ve Subap Lastiksiz











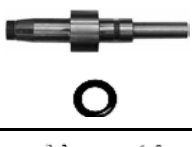
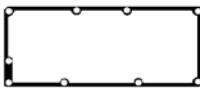





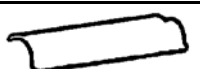



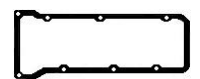



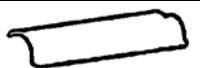

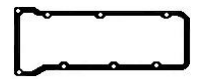

00: Gasket Set Without oil seals Without Valve Stem Seal

01: Motor Takım Keçesiz - Subap Lastikli

01: Gasket set With Valve Stem Seal Without Oil Seals

02: Motor Full Takım Keçeli ve Subap Lastikli

02: Gasket Full Set With oil seals and Valve Stem Seals

Subap Kapak Valve Cover Gasket Zylinderkopfhaube Couvre-culbut.	Karter Oil Pan Ölwanne Carter d'huile	Emme Manifold Intake Manifold Ansaug Admission	Egzoz Manifold Exhaust Manifold Auspuffkrümmer Collecteur D'echappement	Eksoz Boğaz Exhaust Pipe Auspuff Kehle	Supap Keçesi Valve Stem Seal Ventilschaft Queue de soupape	
						
 60345025 2108-1003270	 60345013 2108-1009070	 60345020x2 21083-1008081		 60345018 2101-1203020		
 60311034 2101-1003270	 60311013 2101-1009070	 60311020x2 2101-1008081		 60345018 2101-1203020	 60107027x8 2101-1007026 8x10,8/14,2x10	21201017 40x56x7 LD
 60345025 2108-1003270	 60345013 2108-1009070	 60345020x2 21083-1008081		 60345018 2101-1203020		
 60311034 2101-1003270	 60311013 2101-1009070	 60311020x2 2101-1008081		 60345018 2101-1203020	 60107027x8 2101-1007026 8x10,8/14,2x10	21201017 40x56x7 LD
 64013025 2105-1003270	 64013013 2105-1009070	 60311020x2 2101-1008081		 60345018 2101-1203020	 60107027x8 2101-1007026 8x10,8/14,2x10	21201017 40x56x7 LD

■ : Delik - Çentik

■ : Hole - Notch

■ : Trou - Entaille

NOT: Katalogdaki Orijinal Kodlar Referans Amacıyla Kullanılmıştır.Lütfen COTECH Kodlarını Kullanınız.
Original codes used for reference only.Please use COTECH codes for orders.

00



Silindir Kapak
Cylinder Head

01



Zylinderkopf

02



Joint de culasse

03



04

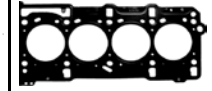

Ltr	MODEL	PS/KW	ENGINE/MOTOR		
1,5 1452	4 CYL ø76 VAZ 2103 11/75-->10/86 VAZ 2107 NIVA 2903	75 PS / 55 KW	OHC	60311002 2101-100001 60311000 2101-100001	 60311005 2101-1003020 1,20mm 60311006 2101-1003020 1,80mm ø77,5
1,5 1452	4 CYL ø79 VAZ 2107 1976-->	75 PS / 55 KW	OHC	64016002 42602555 64016000 42602555	 64016005 21011-13020 1,20mm 64016006 21011-13020 1,80mm ø82
1,5 1499	4 CYL ø82 SAMARA 01/88--> FORMAN VAZ 21083 VAZ 21093 ALEKO SAGONA	75 PS / 55 KW 78 PS / 57 KW 72 PS / 53 KW 71 PS / 52 KW	OHC BA 21083 BA 21093	60345002 2900-4706 60345000 2900-4706	 60345005 21083-1003020 1,50mm ø84
1,5 1499	4 CYL ø82 110 16 V 01/95--> 111 16 V 10/00--> 112 16 V (DOCH)	95 PS / 70 KW 91 PS / 67 KW	VAZ 2112	64101000	 64101005 21120-100302000 1,50mm ø83

▲ : İçerikte Bulunmamaktadır...

▲ : Not included in the set

▲ : Non inclus dans la pochette

00: Motor Takım Keçesiz ve Subap Lastiksiz











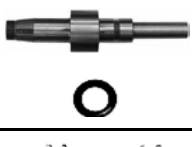
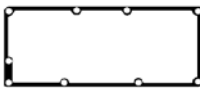





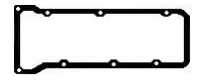
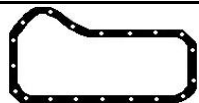



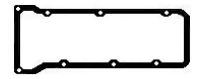

00: Gasket Set Without oil seals Without Valve Stem Seal

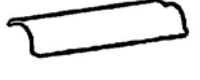
01: Motor Takım Keçesiz - Subap Lastikli

01: Gasket set With Valve Stem Seal Without Oil Seals

02: Motor Full Takım Keçeli ve Subap Lastikli

02: Gasket Full Set With oil seals and Valve Stem Seals

Subap Kapak Valve Cover Gasket Zylinderkopfhaube Couvre-culbut.	Karter Oil Pan Ölwanne Carter d'huile	Emme Manifold Intake Manifold Ansaug Admission	Egzoz Manifold Exhaust Manifold Auspuffkrümmer Collecteur D'echappement	Eksoz Boğaz Exhaust Pipe Auspuff Kehle	Supap Keçesi Valve Stem Seal Ventilschaft Queue de soupape	
						
 60311034 2101-1003270	 60311013 2101-1009070	 60311020x2 2101-1008081		 60345018 2101-1203020	 60107027x8 2101-1007026 8x10,8/14,2x10	21201017 40x56x7 LD
 60311034 2101-1003270	 60311013 2101-1009070	 60311020x2 2101-1008081		 60345018 2101-1203020	 60107027x8 2101-1007026 8x10,8/14,2x10	21201017 40x56x7 LD
 60345025 2108-1003270	 60345013 2108-1009070	 60345020 21083-1008081		 60345018 2101-1203020	 60107027x8 2101-1007026 8x10,8/14,2x10	21201103x2 28x42x7 RD
	 60345013 2108-1009070	 64016018	 64016020 21120-100808900	 64016017		

 : Delik - Çentik

 : Hole - Notch

 : Trou - Entaille

NOT: Katalogdaki Orijinal Kodlar Referans Amacıyla Kullanılmıştır.Lütfen COTECH Kodlarını Kullanınız.
Original codes used for reference only.Please use COTECH codes for orders.

00



Silindir Kapak
Cylinder Head
Zylinderkopf
Joint de culasse

01



02



03



04

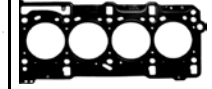

Ltr	MODEL	PS/KW	ENGINE/MOTOR		
1,6 1568	4 CYL ø79 VAZ 2107 04/80-->03/95 NIVA 2121 ALEKO	76 PS / 56 KW 73 PS / 54 KW	BA3	64016002 42602555 64016000 42602555	 64016005 21011-13020 1,20mm 64016006 21011-13020 1,80mm ø82
1,9 1905	4 CYL ø83 NIVA 2121 1990--> ALEKO	65 PS / 47 KW	XUD9(D9A) XUD9	61204002 0197.H5 61204003 0197.H4 	 61204009 0209.S5 1,36 mm 1 61204008 0209.S6 1,40 mm 2 61204007 0209.S7 1,44 mm 3 61204006 0209.S8 1,48 mm 4 61204005 0209.S9 1,53 mm 5 ø 84

▲ : İçerikte Bulunmamaktadır...

▲ : Not included in the set

▲ : Non inclus dans la pochette

00: Motor Takım Keçesiz ve Subap Lastiksiz











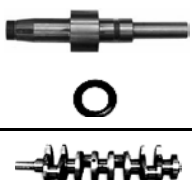
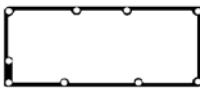





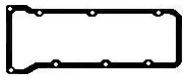
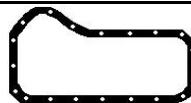

00: Gasket Set Without oil seals Without Valve Stem Seal

01: Motor Takım Keçesiz - Subap Lastikli

01: Gasket set With Valve Stem Seal Without Oil Seals

02: Motor Full Takım Keçeli ve Subap Lastikli

02: Gasket Full Set With oil seals and Valve Stem Seals

Subap Kapak Valve Cover Gasket Zylinderkopfhaube Couvre-culbut.	Karter Oil Pan Ölwanne Carter d'huile	Emme Manifold Intake Manifold Ansaug Admission	Egzoz Manifold Exhaust Manifold Auspuffkrümmer Collecteur D'echappement	Eksoz Boğaz Exhaust Pipe Auspuff Kehle	Supap Keçesi Valve Stem Seal Ventilschaft Queue de soupape	
						
 60311034 2101-1003270	 60311013 2101-1009070	 60311020x2 2101-1008081		 60345018 2101-1203020	 60107027x8 2101-1007026 8x10,8/14,2x10	21201017 40x56x7 LD
 61203525 0249.46 0249.91	 61203013 0304.34  61203014 93501565	 61203116x2 9456044080  61203018x2 91508659	 61205019 1721.01 7810024000  61203120x2 0349.47 93010402  61203021 0348.JO		 60107027x8 2101-1007026 8x10,8/14,2x10	21201011x2 35x50x8 WD 21201019 42x62x8 RD 21201040 90x110x7 LD

 : Delik - Çentik

 : Hole - Notch

 : Trou - Entaille

NOT: Katalogdaki Orijinal Kodlar Referans Amacıyla Kullanılmıştır.Lütfen COTECH Kodlarını Kullanınız.
Original codes used for reference only.Please use COTECH codes for orders.

00
01
02
03
04



Silindir Kapak
Cylinder Head
Zylinderkopf
Joint de culasse

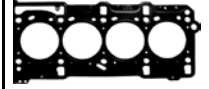

Ltr	MODEL	PS/KW	ENGINE/MOTOR	
2,3 2286	4 CYL ø90,5 88 09/63-->12/86 90 109 110	69 PS / 51 KW	23L	
				 61415105 277819 1,20mm 61415106 277819 1,80mm ø96
2,5 2495	4 CYL ø90,5 90 09/85-->07/90 110 DEFENDER	84 PS / 62 KW	17H	
				 61415105 277819 1,20mm 61415106 277819 1,80mm ø96

▲ : İçerikte Bulunmamaktadır...

▲ : Not included in the set

▲ : Non inclus dans la pochette

00: Motor Takım Keçesiz ve Subap Lastiksiz







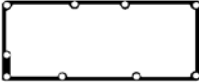

00: Gasket Set Without oil seals Without Valve Stem Seal

01: Motor Takım Keçesiz - Subap Lastikli

01: Gasket set With Valve Stem Seal Without Oil Seals

02: Motor Full Takım Keçeli ve Subap Lastikli

02: Gasket Full Set With oil seals and Valve Stem Seals

<p>Subap Kapak Valve Cover Gasket Zylinderkopfhaube Couvre-culbut.</p> 	<p>Karter Oil Pan Ölwanne Carter d'huile</p> 	<p>Emme Manifold Intake Manifold Ansaug Admission</p> 	<p>Egzoz Manifold Exhaust Manifold Auspuffkrümmer Collecteur D'echappement</p> 	<p>Eksoz Boğaz Exhaust Pipe Auspuff Kehle</p> 	<p>Supap Keçesi Valve Stem Seal Ventilschaft Queue de soupape</p> 	  

■ : Delik - Çentik

■ : Hole - Notch

■ : Trou - Entaille

NOT: Katalogdaki Orijinal Kodlar Referans Amacıyla Kullanılmıştır.Lütfen COTECH Kodlarını Kullanınız.
Original codes used for reference only.Please use COTECH codes for orders.

00



01



02



03



04



Silindir Kapak
Cylinder Head
Zylinderkopf
Joint de culasse

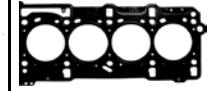

Ltr	MODEL	PS/KW	ENGINE/MOTOR		
2,1 2112	4 CYL ø90 CLASSIC NC 540 DP NC 649 DP NM 550 DP NM 550 XD NM 750 ST NM 775	62 PS / 45 KW	XDP4.90	61212002 0198.40	<p>61212005 0203.70 1,60mm</p> <p>61212006 79 32 566 274 1,80mm</p> <p>ø94</p>
2,5 2498	4 CYL ø94 BOLERO DELIVERY VAN SINGLE CAB DOUBLE CAB NM 540 XDB NM 550 XDB NM 775 RAKSHAK VOYAGER	72 PS / 53 KW 75 PS / 55 KW	XD3P	61218000 0198.94	<p>61218005 6 812 074 1,73mm 4 ▲</p> <p>61218006 6 812 073 1,63mm 3 ▲</p> <p>61218007 6 812 072 1,53mm 2 ▲</p> <p>ø96</p>

▲ : İçerikte Bulunmamaktadır...

▲ : Not included in the set

▲ : Non inclus dans la pochette

00: Motor Takım Keçesiz ve Subap Lastiksiz











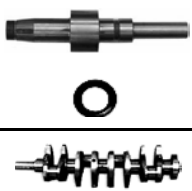
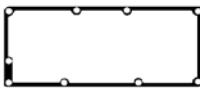

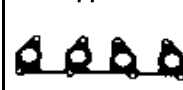



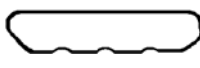



00: Gasket Set Without oil seals Without Valve Stem Seal

01: Motor Takım Keçesiz - Subap Lastikli

01: Gasket set With Valve Stem Seal Without Oil Seals

02: Motor Full Takım Keçeli ve Subap Lastikli

02: Gasket Full Set With oil seals and Valve Stem Seals

Subap Kapak Valve Cover Gasket Zylinderkopfhaube Couvre-culbut.	Karter Oil Pan Ölwanne Carter d'huile	Emme Manifold Intake Manifold Ansaug Admission	Egzoz Manifold Exhaust Manifold Auspuffkrümmer Collecteur D'echappement	Eksoz Boğaz Exhaust Pipe Auspuff Kehle	Supap Keçesi Valve Stem Seal Ventilschaft Queue de soupape	
						
 61212525 1 651 701	 61212014 0313.19  61212015 0304.12	 61212016x3 0348.11	 61212020x2 1 576 449	 61205018 1710.07  61212018 1710.15  61212019 1710.19		21201020 42x60x10 RD
 61212525 1 651 701	 61212014 6 894 122  61212015 0304.12	 61212016x3 0348.11	 61212020x2 0349.10	 61212018 1710.15  61212019 1710.19		

 : Delik - Çentik

 : Hole - Notch

 : Trou - Entaille

NOT: Katalogdaki Orijinal Kodlar Referans Amacıyla Kullanılmıştır.Lütfen COTECH Kodlarını Kullanınız.
Original codes used for reference only.Please use COTECH codes for orders.

00



01



02



03



04



Silindir Kapak
Cylinder Head
Zylinderkopf
Joint de culasse

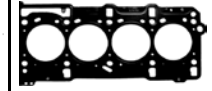

Ltr	MODEL	PS/KW	ENGINE/MOTOR		
1,3 1290	4 CYL ø77 323 08/85-->04/90	60 PS / 44 KW	E3		 61480305 E301-10-271 1,40mm 61480306 E301-10-271 2,00mm ø78,5
1,3 1323	4 CYL ø71 FAMILIA 121 323 09/87-->11/90	60 PS / 44 KW 55 PS / 40 KW	B3		 61410605 B302-10-271 1,60mm 61410606 B302-10-271 2,00mm ø74
1,4 1399	4 CYL ø74 MAZDA 2 04/03-->06/08	68 PS / 50 KW	MZR-CD F6JA F6JB	61706002 Motor Full Takım Gasket Full Set 61706003 Motor Üst Takım Gasket Head Set 61706004 Motor Alt Takım Conversion Set	 61706005 Y401-10-2H1 1,45mm 5 61706006 Y401-10-274 1,40mm 4 61706007 Y401-10-272 1,30mm 3 61706008 Y401-10-271 1,25mm 2 61706009 Y401-10-273 1,35mm 1 MLS ø75

▲ : İçerikte Bulunmamaktadır...

▲ : Not included in the set

▲ : Non inclus dans la pochette

00: Motor Takım Keçesiz ve Subap Lastiksiz









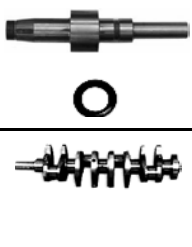
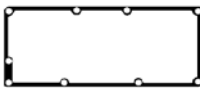

00: Gasket Set Without oil seals Without Valve Stem Seal

01: Motor Takım Keçesiz - Subap Lastikli

01: Gasket set With Valve Stem Seal Without Oil Seals

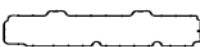
02: Motor Full Takım Keçeli ve Subap Lastikli

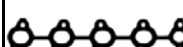
02: Gasket Full Set With oil seals and Valve Stem Seals

Subap Kapak Valve Cover Gasket Zylinderkopfhaube Couvre-culbut.	Karter Oil Pan Ölwanne Carter d'huile	Emme Manifold Intake Manifold Ansaug Admission	Egzoz Manifold Exhaust Manifold Auspuffkrümmer Collecteur D'echappement	Eksoz Boğaz Exhaust Pipe Auspuff Kehle	Supap Keçesi Valve Stem Seal Ventilschaft Queue de soupape	
						
						21204017 27x47x7 RD
61706025 Y401-10-235	62427465	61706019x4 Y401-13-113	61706021 Y401-13-460		61706027x8 Y401-10-155 5,5x9,5x22,9x17,5	21204018 40x55x6,4 LD
						21204019 85x105x8,8 RD

■ : Delik - Çentik

■ : Hole - Notch

■ : Trou - Entaille

NOT: Katalogdaki Orijinal Kodlar Referans Amacıyla Kullanılmıştır.Lütfen COTECH Kodlarını Kullanınız.
Original codes used for reference only.Please use COTECH codes for orders.

00



Silindir Kapak

Cylinder Head

01



Zylinderkopf

02



Joint de culasse

03



04

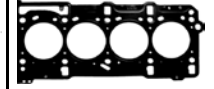

Ltr	MODEL	PS/KW	ENGINE/MOTOR		
1,5 1490	4 CYL ø77 323 05/85-->05/89 GLC FAMILIA FAMILIA TURBO 323 TURBO	75 PS / 55 KW 88 PS / 65 KW 95 PS / 70 KW 115 PS / 85 KW	E5 E5T		<p>61480305 E301-10-271 1,40mm</p> <p>61480306 E301-10-271 2,00mm ø78,5</p>
1,5 1490	4 CYL ø78 818 1972-->1977	100 PS / 73 KW	NA	61420002 8051-99-100	<p>61420005 R201-10-271F 1,50mm</p> <p>61420006 R201-10-271F 2,00mm ø80</p>

▲ : İçerikte Bulunmamaktadır...

▲ : Not included in the set

▲ : Non inclus dans la pochette

00: Motor Takım Keçesiz ve Subap Lastiksiz











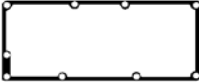

00: Gasket Set Without oil seals Without Valve Stem Seal

01: Motor Takım Keçesiz - Subap Lastikli

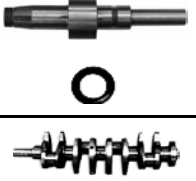
01: Gasket set With Valve Stem Seal Without Oil Seals

02: Motor Full Takım Keçeli ve Subap Lastikli

02: Gasket Full Set With oil seals and Valve Stem Seals

<p>Subap Kapak Valve Cover Gasket Zylinderkopfhaube Couvre-culbut.</p> 	<p>Karter Oil Pan Ölwanne Carter d'huile</p> 	<p>Emme Manifold Intake Manifold Ansaug Admission</p> 	<p>Egzoz Manifold Exhaust Manifold Auspuffkrümmer Collecteur D'echappement</p> 	<p>Eksoz Boğaz Exhaust Pipe Auspuff Kehle</p> 	<p>Supap Keçesi Valve Stem Seal Ventilschaft Queue de soupape</p> 	
 <p>61420034 022110235A</p>	 <p>61420013 0221-10-431</p>	 <p>61420019 038113111A</p>	 <p>61420020 0221-13-462</p>	 <p>61420017 802B-13-483</p>	<p>21201026 48x70x12 RD</p> <p>21201205 80x105x13 LD</p>	

■ : Delik - Çentik

■ : Hole - Notch

■ : Trou - Entaille

NOT: Katalogdaki Orijinal Kodlar Referans Amacıyla Kullanılmıştır.Lütfen COTECH Kodlarını Kullanınız.
Original codes used for reference only.Please use COTECH codes for orders.

00



Silindir Kapak
Cylinder Head

01



Zylinderkopf

02



Joint de culasse

03



04

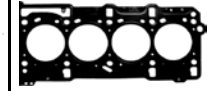

Ltr	MODEL	PS/KW	ENGINE/MOTOR		
1,5 1498	4 CYL ø78 323 16 V (DOCH) 09/98-->01/01	88 PS / 65 KW	ZL		 61420205 ZL01-10-271A 1,20mm FIBER / FIBRE 61420206 ZL01-10-271A 2,00mm FIBER /FIBRE ø79,5
1,5 1498	4 CYL ø78 MAZDA 2 16V (DOCH) 10/07-->	103 PS / 76 KW	ZY-DE ZY-VE		 61420105 ZY01-10-271A 1,20mm FIBER / FIBRE ø79,5
1,6 1560	4 CYL ø75 MAZDA 3 16V (DOCH) 06/04-->06/09	109 PS / 80 KW	Y601	61707002 Motor Full Takım Gasket Full Set 61707003 Motor Üst Takım Gasket Head Set 61706004 Motor Alt Takım Conversion Set	 61707005 Y601-10-2H1 1,45mm 5 61707006 Y601-10-274 1,40mm 4 61707007 Y601-10-272 1,30mm 3 61707008 Y601-10-271 1,25mm 2 61707009 Y601-10-273 1,35mm 1 MLS ø76

▲ : İçerikte Bulunmamaktadır...

▲ : Not included in the set

▲ : Non inclus dans la pochette

00: Motor Takım Keçesiz ve Subap Lastiksiz









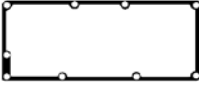
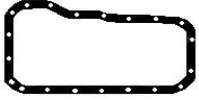

00: Gasket Set Without oil seals Without Valve Stem Seal

01: Motor Takım Keçesiz - Subap Lastikli

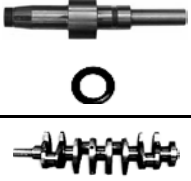
01: Gasket set With Valve Stem Seal Without Oil Seals

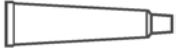
02: Motor Full Takım Keçeli ve Subap Lastikli

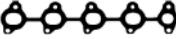
02: Gasket Full Set With oil seals and Valve Stem Seals

<p>Subap Kapak Valve Cover Gasket Zylinderkopfhaube Couvre-culbut.</p> 	<p>Karter Oil Pan Ölwanne Carter d'huile</p> 	<p>Emme Manifold Intake Manifold Ansaug Admission</p> 	<p>Egzoz Manifold Exhaust Manifold Auspuffkrümmer Collecteur D'echappement</p> 	<p>Eksoz Boğaz Exhaust Pipe Auspuff Kehle</p> 	<p>Supap Keçesi Valve Stem Seal Ventilschaft Queue de soupape</p> 	
 <p>61707025 Y601-10-235</p>	 <p>62427465</p>	 <p>Y601-10-238 x4</p>  <p>Y601-13-113 x4</p> <p>61707018</p>	 <p>61706021 Y401-13-460</p>	 <p>61707026x16 Y601-10-155 5,5x9,5x18,1x14</p>	<p>21204017 27x47x7 RD</p> <p>21204018 40x55x6,4 LD</p> <p>21204019 85x105x8,8 RD</p>	

■ : Delik - Çentik

■ : Hole - Notch

■ : Trou - Entaille

NOT: Katalogdaki Orijinal Kodlar Referans Amacıyla Kullanılmıştır.Lütfen COTECH Kodlarını Kullanınız.
Original codes used for reference only.Please use COTECH codes for orders.

00



01



02



03



04



Silindir Kapak
Cylinder Head
Zylinderkopf
Joint de culasse



Ltr	MODEL	PS/KW	ENGINE/MOTOR		
1,6 1586	4 CYL ø78 616 1970->1978 626 1979->1982 818 1971->1978 B 1600 1971->1975 CAPELLA 1971->1975 PICK-UP 1971->1975	75 PS / 55 KW	NA	61420002 8051-99-100	 61420005 R201-10-271F 1,50mm 61420006 R201-10-271F 2,00mm ø80
1,6 1587	4 CYL ø81 CAPELLA 11/82-->09/87 626 (SOCH)	80 PS / 59 KW	F6		 61420505 F501-10-F271 1,80mm ø83,5
1,6 1596	4 CYL ø79 MAZDA 2 16V 10/03--> (DOCH)	101 PS 74 KW	C6 FYJA		 62218205 1 305 949 1,20mm FIBER / FIBRE ø80
1,6 1597	4 CYL ø78 PROTEGE 16V 01/01-->05/04 323 (DOCH)	98 PS / 72 KW 95 PS / 70 KW	ZM		 61420205 ZL01-10-271A 1,20mm FIBER / FIBRE 61420206 ZL01-10-271A 2,00mm FIBER / FIBRE ø79,5
1,6 1598	4 CYL ø78 MAZDA 3 16V 10/03--> (DOCH)	105 PS / 77 KW	Z6 B6ZE LF		 61420105 ZY01-10-271A 1,20mm FIBER / FIBRE ø79,5

▲ : İçerikte Bulunmamaktadır...

▲ : Not included in the set

▲ : Non inclus dans la pochette

00: Motor Takım Keçesiz ve Subap Lastiksiz











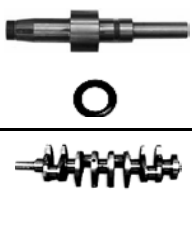
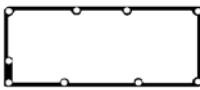

00: Gasket Set Without oil seals Without Valve Stem Seal

01: Motor Takım Keçesiz - Subap Lastikli

01: Gasket set With Valve Stem Seal Without Oil Seals

02: Motor Full Takım Keçeli ve Subap Lastikli

02: Gasket Full Set With oil seals and Valve Stem Seals

Subap Kapak Valve Cover Gasket Zylinderkopfhaube Couvre-culbut.	Karter Oil Pan Ölwanne Carter d'huile	Emme Manifold Intake Manifold Ansaug Admission	Egzoz Manifold Exhaust Manifold Auspuffkrümmer Collecteur D'echappement	Eksoz Boğaz Exhaust Pipe Auspuff Kehle	Supap Keçesi Valve Stem Seal Ventilschaft Queue de soupape	
						
 61420034 022110235A	 61420013 0221-10-431	 61420019 038113111A	 61420020 0221-13-462	 61420017 802B-13-483		21201026 48x70x12 RD
						21201205 80x105x13 LD

 : Delik - Çentik

 : Hole - Notch

 : Trou - Entaille

NOT: Katalogdaki Orijinal Kodlar Referans Amacıyla Kullanılmıştır.Lütfen COTECH Kodlarını Kullanınız.
Original codes used for reference only.Please use COTECH codes for orders.

00



Silindir Kapak
Cylinder Head
Zylinderkopf
Joint de culasse

01



02



03



04



Ltr	MODEL	PS/KW	ENGINE/MOTOR		
1,6 1598	4 CYL ø78 323 (SOCH) 09/89-->10/94	84 PS / 62 KW 88 PS / 65 KW	B6		 61480205 0B61L10271A 1,30mm ø79,5
1,8 1789	4 CYL ø86 CAPELLA 626 929 (SOCH) 08/87-->	90 PS / 66 KW	F8		 61420305 F202-10-271 1,40mm 61420306 F202-10-271 1,80mm ø87,5
2,0 1998	4 CYL ø86 626 12V 929 12V CAPELLA E 2000 (SOCH) 03/83-->05/03	120 PS / 88 KW 82 PS / 60 KW	FE FA FEV4 FE18 FE58 FE60 FE61		 61420305 F202-10-271 1,40mm 61420306 F202-10-271 1,80mm ø87,5
2,0 1998	4 CYL ø86 626 16V CAPELLA 16V (DOCH) 06/87-->05/92	148 PS / 109 KW 140 PS / 103 KW	FE		 61410305 OK013 10 271 1,20mm FIBER / FIBRE ø87,5
2,0 1998	4 CYL ø86 E 2000 626 CAPELLA 10/92-->04/97 01/83-->02/88	75 PS / 55 KW 63 PS / 46 KW	RF	61410000 RF01-99-100	 61410005 R201-10-271A ø87,5
2,0 1999	4 CYL ø87,5 MAZDA 6 16V MAZDA 3 16V (DOCH) 06/02-->02/05	141 PS / 104 KW 150 PS / 110 KW	LF17 LF18		 61420405 1 229 872 1,20mm FIBER / FIBRE ø89

▲ : İçerikte Bulunmamaktadır...

▲ : Not included in the set

▲ : Non inclus dans la pochette

00: Motor Takım Keçesiz ve Subap Lastiksiz









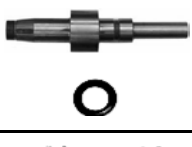
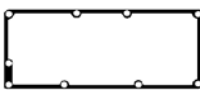

00: Gasket Set Without oil seals Without Valve Stem Seal

01: Motor Takım Keçesiz - Subap Lastikli

01: Gasket set With Valve Stem Seal Without Oil Seals

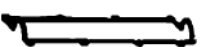
02: Motor Full Takım Keçeli ve Subap Lastikli

02: Gasket Full Set With oil seals and Valve Stem Seals

Subap Kapak Valve Cover Gasket Zylinderkopfhaube Couvre-culbut.	Karter Oil Pan Ölwanne Carter d'huile	Emme Manifold Intake Manifold Ansaug Admission	Egzoz Manifold Exhaust Manifold Auspuffkrümmer Collecteur D'echappement	Eksoz Boğaz Exhaust Pipe Auspuff Kehle	Supap Keçesi Valve Stem Seal Ventilschaft Queue de soupape	
						
						
61410025 RF01-10-235	61410013 F80110-431	61410019 RF0113-111	61410020 RF01-13-462			

■ : Delik - Çentik

■ : Hole - Notch

■ : Trou - Entaille

NOT: Katalogdaki Orjinal Kodlar Referans Amacıyla Kullanılmıştır.Lütfen COTECH Kodlarını Kullanınız.
Original codes used for reference only.Please use COTECH codes for orders.

00



01



02



03



04



Silindir Kapak
Cylinder Head
Zylinderkopf
Joint de culasse

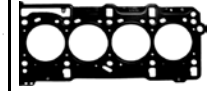

Ltr	MODEL	PS/KW	ENGINE/MOTOR		
2,2 2184	4 CYL ø86 929 11/87-->11/96 B 2200 626 TURBO 12V MX-6 TURBO 12V BT-50 929 12V 626 12V (SOCH)	115 PS / 85 KW	F2 F2L		61420305 F202-10-271 1,40mm 61420306 F202-10-271 1,80mm ø87,5
2,2 2184	4 CYL ø86 E 2200 01/84-->05/03 B 2200	71 PS / 52 KW 63 PS / 46 KW	R2 R203 R207 R281 R290	61410000 RF01-99-100	61410005 R201-10-271A FIBER / FIBRE ø87,5
2,2 2209	4 CYL ø89 B 2200 1979-->1981 LUCE	63 PS / 46 KW	S2		61480005 0527-10-271A ø97
2,2 2261	4 CYL ø87,5 MAZDA 6 16V 07/02-->08/07 MPV 16V TRIBUTE 16V (DOCH)	150 PS / 110 KW 141 PS / 104 KW 166 PS / 122 KW 162 PS / 119 KW	L3		61420405 1 229 872 1,20mm FIBER / FIBRE ø89
2,5 2522	4 CYL ø89 E 2500 1973-->1977	81 PS / 77 KW	XA	61480000 0527-99-100	61480005 0527-10-271A ø97
2,7 2701	4 CYL ø89 E 2700 1973-->1977	81 PS / 77 KW	XB	61480000 0527-99-100	61480005 0527-10-271A ø97

▲ : İçerikte Bulunmamaktadır...

▲ : Not included in the set

▲ : Non inclus dans la pochette

00: Motor Takım Keçesiz ve Subap Lastiksiz











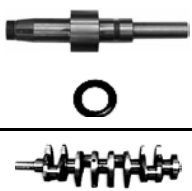
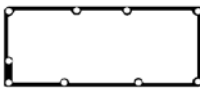



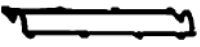

00: Gasket Set Without oil seals Without Valve Stem Seal

01: Motor Takım Keçesiz - Subap Lastikli

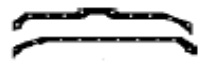
01: Gasket set With Valve Stem Seal Without Oil Seals

02: Motor Full Takım Keçeli ve Subap Lastikli

02: Gasket Full Set With oil seals and Valve Stem Seals

Subap Kapak Valve Cover Gasket Zylinderkopfhaube Couvre-culbut.	Karter Oil Pan Ölwanne Carter d'huile	Emme Manifold Intake Manifold Ansaug Admission	Egzoz Manifold Exhaust Manifold Auspuffkrümmer Collecteur D'echappement	Eksoz Boğaz Exhaust Pipe Auspuff Kehle	Supap Keçesi Valve Stem Seal Ventilschaft Queue de soupape	
						
						
61410025 RF01-10-235	61410013 F80110-431	61410019 RF0113-111	61410020 RF01-13-462			
						
61480025 1456-10-235	61480013 1363-89-104	61480019x4 0636-13-111	61480021x4 0750-13-461 0750-13-461A			
						
61480025 1456-10-235	61480013 1363-89-104	61480019x4 0636-13-111	61480021x4 0750-13-461 0750-13-461A			

 : Delik - Çentik

 : Hole - Notch

 : Trou - Entaille

NOT: Katalogdaki Orijinal Kodlar Referans Amacıyla Kullanılmıştır. Lütfen COTECH Kodlarını Kullanınız.
Original codes used for reference only. Please use COTECH codes for orders.

00
01
02
03
04



Silindir Kapak
Cylinder Head
Zylinderkopf
Joint de culasse

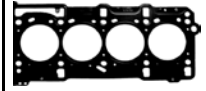

Ltr	MODEL	PS/KW	ENGINE/MOTOR	
1,3 1298	4 CYL ø71 COLT 06/86-->05/92 LANCER MIRAGE PROTON SAGA (SOHC)	70 PS / 51 KW 60 PS / 44 KW	G13B 4G13 4G13B	 61507005 MD066163 1,40mm ø72,5
1,3 1298	4 CYL ø71 COLT 12V 07/90-->05/94 LANCER 12V MIRAGE 12V LIBERO 12V LIBERO CARGO 12V PROTON PERSONA 12V (SOHC)	75 PS / 55 KW 60 PS / 44 KW	4G13	 61415405 MD323473 1,40mm ø76,5
1,5 1468	4 CYL ø75,5 COLT 11/83-->08/89 LANCER (SOHC) MIRAGE PRECIS PROTON SAGA	75 PS / 55 KW 70 PS / 50 KW 84 PS / 62 KW	4G15 G15B	 61500305 MD016163 1,40mm 61500306 MD016163 2,00mm ø76,5
1,5 1468	4 CYL ø75,5 COLT 12V 05/89-->08/99 LANCER 12V MIRAGE 12V LIBERO 12V LIBERO CARGO 12V PROTON SAGA 12V PROTON PERSONA 12V (SOHC)	110 PS / 81 KW 86 PS / 63 KW 90 PS / 66 KW	4G15	 61415405 MD323473 1,40mm ø76,5
1,6 1584	4 CYL ø76 LANCER 09/03--> SPACE STAR 01/01-->12/04	98 PS / 72 KW	4G18	 61415305 MD342397 1,80mm 61415306 MD342397 2,00mm FIBER / FIBRE ø77

▲ : İçerikte Bulunmamaktadır...

▲ : Not included in the set

▲ : Non inclus dans la pochette

00: Motor Takım Keçesiz ve Subap Lastiksiz







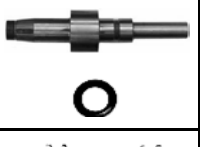

00: Gasket Set Without oil seals Without Valve Stem Seal

01: Motor Takım Keçesiz - Subap Lastikli

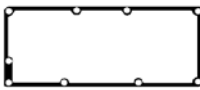
01: Gasket set With Valve Stem Seal Without Oil Seals

02: Motor Full Takım Keçeli ve Subap Lastikli

02: Gasket Full Set With oil seals and Valve Stem Seals

Subap Kapak Valve Cover Gasket Zylinderkopfhaube Couvre-culbut.	Karter Oil Pan Ölwanne Carter d'huile	Emme Manifold Intake Manifold Ansaug Admission	Egzoz Manifold Exhaust Manifold Auspuffkrümmer Collecteur D'echappement	Eksoz Boğaz Exhaust Pipe Auspuff Kehle	Supap Keçesi Valve Stem Seal Ventilschaft Queue de soupape	 
						

 : Delik - Çentik

 : Hole - Notch

 : Trou - Entaille

NOT: Katalogdaki Orijinal Kodlar Referans Amacıyla Kullanılmıştır. Lütfen COTECH Kodlarını Kullanınız.
Original codes used for reference only. Please use COTECH codes for orders.

00



Silindir Kapak

Cylinder Head

01



Zylinderkopf

02



Joint de culasse

03



04

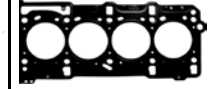

Ltr	MODEL	PS/KW	ENGINE/MOTOR	
2,0	4 CYL ø85			
1997	ETERNA SAPORO COLT GALANT SIGMA STARION PAJERO SPACE WAGON GALANT TURBO CORDIA PICK-UP TREDIA STARION TURBO EXPO L200 L300 NIMBUS EXPO CHARIOT GRANDIS (SOCH)	90 PS / 66 KW 84 PS / 62 KW 102 PS / 75 KW	G63B G63B Turbo 4G63 G63BT	
				 61500905 MD040533 1,40mm 61500906 MD040533 2,00mm ø86

▲ : İçerikte Bulunmamaktadır...

▲ : Not included in the set

▲ : Non inclus dans la pochette

00: Motor Takım Keçesiz ve Subap Lastiksiz







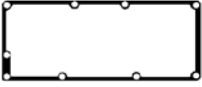
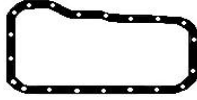

00: Gasket Set Without oil seals Without Valve Stem Seal

01: Motor Takım Keçesiz - Subap Lastikli

01: Gasket set With Valve Stem Seal Without Oil Seals

02: Motor Full Takım Keçeli ve Subap Lastikli

02: Gasket Full Set With oil seals and Valve Stem Seals

<p>Subap Kapak Valve Cover Gasket Zylinderkopfhaube Couvre-culbut.</p> 	<p>Karter Oil Pan Ölwanne Carter d'huile</p> 	<p>Emme Manifold Intake Manifold Ansaug Admission</p> 	<p>Egzoz Manifold Exhaust Manifold Auspuffkrümmer Collecteur D'echappement</p> 	<p>Eksoz Boğaz Exhaust Pipe Auspuff Kehle</p> 	<p>Supap Keçesi Valve Stem Seal Ventilschaft Queue de soupape</p> 	  

■ : Delik - Çentik

■ : Hole - Notch

■ : Trou - Entaille

NOT: Katalogdaki Orijinal Kodlar Referans Amacıyla Kullanılmıştır.Lütfen COTECH Kodlarını Kullanınız.
Original codes used for reference only.Please use COTECH codes for orders.

00



01



02



03



04



Silindir Kapak
Cylinder Head
Zylinderkopf
Joint de culasse

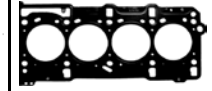

Ltr	MODEL	PS/KW	ENGINE/MOTOR		
2,3 2346	4 CYL ø91 L200 D 04/83-->10/86 L300D CANTER D MONTERO D PAJERO D SIGMA D SPX D (SOCH)	68 PS / 50 KW	4D55 4D55T	61450001 MD050092 61450002 MD050092	 61450005 MD050545 1,80mm ø92,5
2,5 2476	4 CYL ø91 L200D 11/86-->10/96 MONTERO D PAJERO D CANTER T35 D DELICA TD L200 TD L300 TD L400 TD SPACE GEAR TD	69 PS / 51 KW 70 PS / 51 KW 87 PS / 64 KW 95 PS / 70 KW	4D56 4D56T	61450001 MD050092 	 61470005 MD302893 1,60mm 5 61470006 22311-42525 1,55mm 4 61470007 22311-42855 1,50mm 3 61470008 22311-42515 1,45mm 2 ø92,5
2,5 2476	4 CYL ø91 L200TD 05/86--> L300D L300TD L400TD PAJERO TD SPACE GEAR TD MONTERO TURBO PAJERO TURBO	133 PS / 98 KW 84 PS / 62 KW 115 PS / 85 KW 99 PS / 73 KW	4D56T	61470002 1000A901 	 61470005 MD302893 1,60mm 5 61470006 22311-42525 1,55mm 4 61470007 22311-42855 1,50mm 3 61470008 22311-42515 1,45mm 2 ø92,5

▲ : İçerikte Bulunmamaktadır...

▲ : Not included in the set

▲ : Non inclus dans la pochette

00: Motor Takım Keçesiz ve Subap Lastiksiz











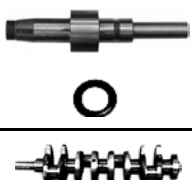
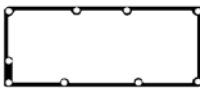

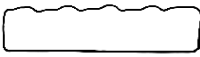

00: Gasket Set Without oil seals Without Valve Stem Seal

01: Motor Takım Keçesiz - Subap Lastikli

01: Gasket set With Valve Stem Seal Without Oil Seals

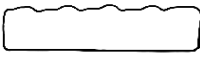
02: Motor Full Takım Keçeli ve Subap Lastikli

02: Gasket Full Set With oil seals and Valve Stem Seals

Subap Kapak Valve Cover Gasket Zylinderkopfhaube Couvre-culbut.	Karter Oil Pan Ölwanne Carter d'huile	Emme Manifold Intake Manifold Ansaug Admission	Egzoz Manifold Exhaust Manifold Auspuffkrümmer Collecteur D'echappement	Eksoz Boğaz Exhaust Pipe Auspuff Kehle	Supap Keçesi Valve Stem Seal Ventilschaft Queue de soupape	
						
61450025 MD050312	61450013 MD149392	61450021 MD050482			61450026x8 8x13x9x13	21201013 35x50x8 RD
						21201023 44x60x7 RD
						21201035 80x96x9 LD
						21201004 25x35x6
						21201001 17x28x7
						21201013 35x50x8 RD
61450025 MD050312	61450013 MD149392	61450021 MD050482			61450026x8 8x13x9x13	21201023 44x60x7 RD
						21201035 80x96x9 LD
						21201004 25x35x6
						21201001 17x28x7
						21201013 35x50x8 RD
61450025 MD050312	61450013 MD149392	61470021 28520-42070			61450026x8 8x13x9x13	21201023 44x60x7 RD
						21201035 80x96x9 LD
						21201004 25x35x6
						21201001 17x28x7

■ : Delik - Çentik

■ : Hole - Notch

■ : Trou - Entaille

NOT: Katalogdaki Orijinal Kodlar Referans Amacıyla Kullanılmıştır.Lütfen COTECH Kodlarını Kullanınız.
Original codes used for reference only.Please use COTECH codes for orders.

00



Silindir Kapak
Cylinder Head

01



Zylinderkopf

02



Joint de culasse

03



04

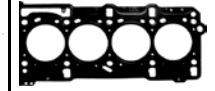

Ltr	MODEL	PS/KW	ENGINE/MOTOR		
1,0 988	4 CYL ø73 SUNNY CHERRY 09/70-->09/78	45 PS / 33 KW	A10		 61412005 11044-H3901 1,60mm ø76
1,2 1149	4 CYL ø69 KUBISTAR 04/06-->	75 PS / 55 KW	D4F 712	60108603 77 01 473 003	 60108605 8200062273 MLS ø70
1,2 1171	4 CYL ø73 SUNNY CHERRY 07/78-->08/81	52 PS / 38 KW	A12		 61412005 11044-H3901 1,60mm ø76
1,3 1270	4 CYL ø76 SUNNY PULSAR LANGREY 08/81-->10/86	60 PS / 44 KW	E13S		 61412105 11044-01M10 1,20mm ø77,5
1,4 1397	4 CYL ø76 CHERRY SUNNY B 310 08/80-->07/81	80 PS / 59 KW	A14S		 61412205 11044-H7200 1,20mm ø77,5
1,4 1397	4 CYL ø73 SUNNY 06/79-->02/82	65 PS / 48 KW 67 PS / 49 KW	A14		 61412005 11044-H3901 1,60mm ø76

▲ : İçerikte Bulunmamaktadır...

▲ : Not included in the set

▲ : Non inclus dans la pochette

00: Motor Takım Keçesiz ve Subap Lastiksiz











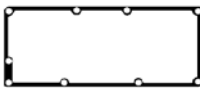

00: Gasket Set Without oil seals Without Valve Stem Seal

01: Motor Takım Keçesiz - Subap Lastikli

01: Gasket set With Valve Stem Seal Without Oil Seals

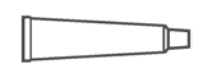
02: Motor Full Takım Keçeli ve Subap Lastikli

02: Gasket Full Set With oil seals and Valve Stem Seals

Subap Kapak Valve Cover Gasket Zylinderkopfhaube Couvre-culbut.	Karter Oil Pan Ölwanne Carter d'huile	Emme Manifold Intake Manifold Ansaug Admission	Egzoz Manifold Exhaust Manifold Auspuffkrümmer Collecteur D'echappement	Eksoz Boğaz Exhaust Pipe Auspuff Kehle	Supap Keçesi Valve Stem Seal Ventilschaft Queue de soupape	
						
						21204701 28x47x8 RD
60108625 77 01 049 888	62427465	60108618 77 01 473 007	60108621 77 00 115 971		60108626x16 5,5x11x23x15,7	

 : Delik - Çentik

 : Hole - Notch

 : Trou - Entaille

NOT: Katalogdaki Orijinal Kodlar Referans Amacıyla Kullanılmıştır.Lütfen COTECH Kodlarını Kullanınız.
Original codes used for reference only.Please use COTECH codes for orders.

00



Silindir Kapak
Cylinder Head

01



Zylinderkopf

02



Joint de culasse

03



04



Ltr	MODEL	PS/KW	ENGINE/MOTOR		
1,5 1461	4 CYL ø76 ALMERA DCI 01/03--> KUBISTAR DCI MICRA DCI NOTE DCI	82 PS / 60 KW 65 PS / 48 KW	K9K 700 K9K 704 K9K 722	62457102 Motor Full Takım Gasket Full Set 62457103 77 01 473 371 62457104 Motor Alt Takım Conversion Set	 62457105 82 00 071 111 0,60mm 62457106 82 00 071 111 0,82mm MLS ø77,5
1,5 1483	4 CYL ø78 PICK-UP CABSTAR HOMY TRUCK HOMER	78 PS / 57 KW	J15		 61412305 11044-A3800 1,80mm ø80
1,5 1487	4 CYL ø76 SUNNY 03/82-->08/90 PULSAR LANGREY SENTRA	75 PS / 55 KW	E15S/E		 61412105 11044-01M10 1,20mm ø77,5
1,5 1487	4 CYL ø76 VANETTE 07/81-->12/95 SUNNY B 310	82 PS / 60 KW	A15S		 61412205 11044-H7200 1,20mm ø77,5
1,5 1487	4 CYL ø76 TSURU 1984-->1994 SAMURAI SEDAN NINJA GAYIN (SOCH) (Mexico)	75 PS / 55 KW	E15		 61412105 11044-01M10 1,20mm ø77,5
1,5 1487	4 CYL ø76 FORKLIFT 1985-->	82 PS / 60 KW	A15		 61412205 11044-H7200 1,20mm ø77,5

▲ : İçerikte Bulunmamaktadır...

▲ : Not included in the set

▲ : Non inclus dans la pochette

00: Motor Takım Keçesiz ve Subap Lastiksiz









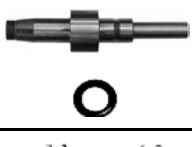
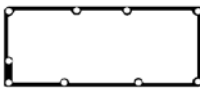

00: Gasket Set Without oil seals Without Valve Stem Seal

01: Motor Takım Keçesiz - Subap Lastikli

01: Gasket set With Valve Stem Seal Without Oil Seals

02: Motor Full Takım Keçeli ve Subap Lastikli

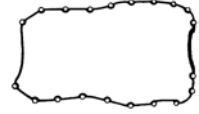
02: Gasket Full Set With oil seals and Valve Stem Seals

Subap Kapak Valve Cover Gasket Zylinderkopfhaube Couvre-culbut.	Karter Oil Pan Ölwanne Carter d'huile	Emme Manifold Intake Manifold Ansaug Admission	Egzoz Manifold Exhaust Manifold Auspuffkrümmer Collecteur D'echappement	Eksoz Boğaz Exhaust Pipe Auspuff Kehle	Supap Keçesi Valve Stem Seal Ventilschaft Queue de soupape	
						
						21204024 28x42x5 RD
62457125 13270-00Q0B	62457165 77 00 273 486		62457121 14036-BN700		62457144x8 77 00 109 840 6x8,8x12,2x9,7	21204025 35x47x7 RD
						21204033 80x100x9 LD

 : Delik - Çentik

 : Hole - Notch

 : Trou - Entaille

NOT: Katalogdaki Orijinal Kodlar Referans Amacıyla Kullanılmıştır.Lütfen COTECH Kodlarını Kullanınız.
Original codes used for reference only.Please use COTECH codes for orders.

00



Silindir Kapak
Cylinder Head

01



Zylinderkopf

02



Joint de culasse

03



04



Ltr	MODEL	PS/KW	ENGINE/MOTOR		
1,6 1567	4 CYL ø78 GUAYIN SEDAN PICK-UP (Mexico) 1970-->1985	78 PS / 57 KW	J16		 61412305 11044-A3800 1,80mm ø80
1,6 1567	4 CYL ø78 CABSTAR CARAVAN HOMER TRUCK 1970-->1978	80 PS / 60 KW	J16		 61412305 11044-A3800 1,80mm ø80
1,6 1597	4 CYL ø76 TSURU SAMURAI SEDAN NINJA GAYIN (SOCH) (Mexico) 1984-->1994	75 PS / 55 KW	E16		 61412105 11044-01M10 1,20mm ø77,5
1,6 1598	4 CYL ø79,5 KUBISTAR 16V 08/03-->	95 PS / 70 KW	K4M 752	62457202 Motor Full Takım Gasket Full Set 62457203 77 01 471 886	 62457205 77 00 112 739 MLS ø80,5

▲ : İçerikte Bulunmamaktadır...

▲ : Not included in the set

▲ : Non inclus dans la pochette

00: Motor Takım Keçesiz ve Subap Lastiksiz









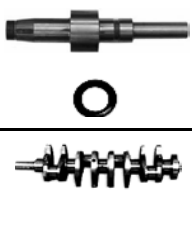
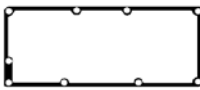

00: Gasket Set Without oil seals Without Valve Stem Seal

01: Motor Takım Keçesiz - Subap Lastikli

01: Gasket set With Valve Stem Seal Without Oil Seals

02: Motor Full Takım Keçeli ve Subap Lastikli

02: Gasket Full Set With oil seals and Valve Stem Seals

Subap Kapak Valve Cover Gasket Zylinderkopfhaube Couvre-culbut.	Karter Oil Pan Ölwanne Carter d'huile	Emme Manifold Intake Manifold Ansaug Admission	Egzoz Manifold Exhaust Manifold Auspuffkrümmer Collecteur D'echappement	Eksoz Boğaz Exhaust Pipe Auspuff Kehle	Supap Keçesi Valve Stem Seal Ventilschaft Queue de soupape	
						
						21204024x2 28x42x5 RD
	62457265 77 00 103 687	62457219 77 00 105 852	62457221 77 00 107 181		62457244x16 77 00 103 938 5,5x11x28x16,4	21204005 35x47x7 RD
						21204009 80x100x8 LD

■ : Delik - Çentik

■ : Hole - Notch

■ : Trou - Entaille

NOT: Katalogdaki Orijinal Kodlar Referans Amacıyla Kullanılmıştır.Lütfen COTECH Kodlarını Kullanınız.
Original codes used for reference only.Please use COTECH codes for orders.

00



Silindir Kapak

Cylinder Head

01



Zylinderkopf

02









Joint de culasse

03



04

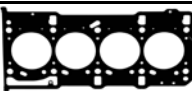

Ltr	MODEL	PS/KW	ENGINE/MOTOR		
1,3 1242	4 CYL ø69,6 ASTRA J CDTI 07/06--> COMBO CDTI CORSA D CDTI MERIVA B CDTI	95 PS / 70 KW 75 PS / 55 KW	A 13 DTC A 13 DTE A 13 DTR A 13 FD Z 13 DTE Z 13 DTI Z 13 DTR	62427502 Motor Full Takım Gasket Full Set   62427503 66 06 041  62427504 66 06 040 	 62427505 56 07 639 0,72mm 62427506 56 07 640 0,82mm 1  62427507 56 07 641 0,92mm 2  MLS ø70,5

▲ : İçerikte Bulunmamaktadır...

▲ : Not included in the set

▲ : Non inclus dans la pochette

00: Motor Takım Keçesiz ve Subap Lastiksiz







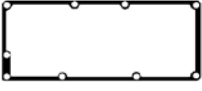
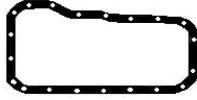

00: Gasket Set Without oil seals Without Valve Stem Seal

01: Motor Takım Keçesiz - Subap Lastikli

01: Gasket set With Valve Stem Seal Without Oil Seals

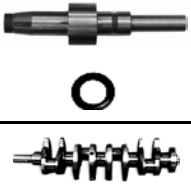
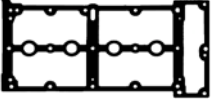
02: Motor Full Takım Keçeli ve Subap Lastikli

02: Gasket Full Set With oil seals and Valve Stem Seals

<p>Subap Kapak Valve Cover Gasket Zylinderkopfhaube Couvre-culbut.</p> 	<p>Karter Oil Pan Ölwanne Carter d'huile</p> 	<p>Emme Manifold Intake Manifold Ansaug Admission</p> 	<p>Egzoz Manifold Exhaust Manifold Auspuffkrümmer Collecteur D'echappement</p> 	<p>Eksoz Boğaz Exhaust Pipe Auspuff Kehle</p> 	<p>Supap Keçesi Valve Stem Seal Ventilschaft Queue de soupape</p> 	
 <p>62427425 56 07 842</p>		 <p>62427518x4 850 933</p>	 <p>62427421 849 219</p>		 <p>62427426x16 642 533 6x8,8x11,7x9,5</p>	<p>21204023 40x52x7 RD</p> <p>21204034 78X100X9 RD</p>

■ : Delik - Çentik

■ : Hole - Notch

■ : Trou - Entaille

NOT: Katalogdaki Orijinal Kodlar Referans Amacıyla Kullanılmıştır.Lütfen COTECH Kodlarını Kullanınız.
Original codes used for reference only.Please use COTECH codes for orders.

00



Silindir Kapak
Cylinder Head
Zylinderkopf
Joint de culasse

01



02







03

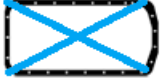

04

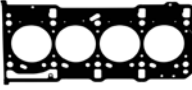

Ltr	MODEL	PS/KW	ENGINE/MOTOR		
1,3 1248	4 CYL ø69,6 AGILA CDTI 06/03--> COMBO TD COMBO CDTI CORSA C CDTI CORSA C DTI CORSA D CDTI MERIVA CDTI TIGRA CDTI ASTRA H CDTI 04/05--> CORSA D CDTI	75 PS / 55 KW 69 PS / 51 KW 90 PS / 66 KW	D 13 A Y 13 DT Z 13 DT Z 13 DTJ Z 13 DTH	62427402 Motor Full Takım Gasket Full Set   62427403 16 06 458 16 06 455  62427404 16 06 456 16 06 454 	 62427505 56 07 639 0,72mm 62427506 56 07 640 0,82mm 1 ■ 62427507 56 07 641 0,92mm 2 ■ MLS ø70,5
1,3 1297	4 CYL ø75 CORSA A 08/79-->03/93 KADETT D KADETT E ASCONA B 03/79-->08/91 ASCONA C KADETT D KADETT E MANTA B CORSA A 09/84-->08/91 KADETT E ASCONA B 03/75-->03/93 ASCONA C CORSA A KADETT D KADETT E MANTA B	60 PS / 44 KW 60 PS / 44 KW 60 PS / 44 KW 75 PS / 55 KW 57 PS / 42 KW	C 13 N 13 N 13 NB 13 S 13 SB		 62447905 607990 ø76,5

▲ : İçerikte Bulunmamaktadır...

▲ : Not included in the set

▲ : Non inclus dans la pochette

00: Motor Takım Keçesiz ve Subap Lastiksiz







00: Gasket Set Without oil seals Without Valve Stem Seal

01: Motor Takım Keçesiz - Subap Lastikli

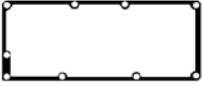
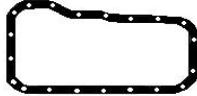
01: Gasket set With Valve Stem Seal Without Oil Seals

02: Motor Full Takım Keçeli ve Subap Lastikli

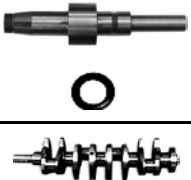
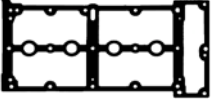
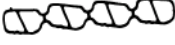
02: Gasket Full Set With oil seals and Valve Stem Seals

<p>Subap Kapak Valve Cover Gasket Zylinderkopfhaube Couvre-culbut.</p> 	<p>Karter Oil Pan Ölwanne Carter d'huile</p> 	<p>Emme Manifold Intake Manifold Ansaug Admission</p> 	<p>Egzoz Manifold Exhaust Manifold Auspuffkrümmer Collecteur D'echappement</p> 	<p>Eksoz Boğaz Exhaust Pipe Auspuff Kehle</p> 	<p>Supap Keçesi Valve Stem Seal Ventilschaft Queue de soupape</p> 	
 <p>62427425 56 07 842</p>		 <p>62427417 58 50 674</p>	 <p>62427421 849 219</p>		 <p>62427426x16 1 547 971 6x8,8x11,7x9,5</p>	<p>21204023 40x52x7 RD</p> <p>21204034 78x100x9 RD</p>

■ : Delik - Çentik

■ : Hole - Notch

■ : Trou - Entaille

NOT: Katalogdaki Orijinal Kodlar Referans Amacıyla Kullanılmıştır.Lütfen COTECH Kodlarını Kullanınız.
Original codes used for reference only.Please use COTECH codes for orders.

00



01



02



03



04



Silindir Kapak
Cylinder Head
Zylinderkopf
Joint de culasse

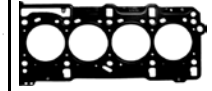

Ltr	MODEL	PS/KW	ENGINE/MOTOR		
1,4 1389	4 CYL ø77,6 ASTRA F 09/91-->09/93 CORSA A 09/89-->03/93 KADETT E 07/89-->02/93 VECTRA A 04/88-->06/92 ASTRA F 09/91-->01/05 COMBO 07/94-->10/01 CORSA A 10/89-->03/93 CORSA B 03/93-->09/00 KADETT E 01/90-->07/94 (OHC)	75 PS / 55 KW 54 PS / 40KW 60 PS / 44 KW	14 NV C 14 NZ X 14 NZ X 14 SZ	62447202 1606697+1606728 62447203 1606697 62447204 1606728	 62447205 607449 1,80mm ø79,5
1,4 1389	4 CYL ø77,6 ASTRA F 03/92-->03/01 COMBO 07/94-->10/01 CORSA A 09/91-->03/93 CORSA B 03/93-->09/00 KADETT E 09/89-->08/91 (OHC)	82 PS / 90 KW	14 SE C 14 SE	62447102 1606730+ 1606728 62447103 1606730 62447204 1606728	 62447205 607449 1,80mm ø79,5
1,4 1389	4 CYL ø77,6 ASTRA F 01/96-->03/01 COMBO 08/99-->10/01 CORSA B 09/94-->09/00 TIGRA 07/94-->12/00 (DOCH 16V)	90 PS / 66 KW	C 14 SEL X 14 XE	62447802 1606034+1606790 62447803 1606034 62447404 1606790	 62447805 5607410 1,40mm ø79,5
1,4 1389	4 CYL ø77,6 ASTRA G 02/98-->01/05 (DOCH 16V)	90 PS / 66 KW	X 14 XE	62448402 1606381+1606790 62448403 1606381 62447404 1606790	 62447805 5607410 1,40mm ø79,5
1,4 1389	4 CYL ø77,6 CORSA C 2000--> (DOCH 16V)	90 PS / 66 KW	Z 14 XE	62448003 1606097 62448004 1606170	 62448005 607410 MLS ø79,3

▲ : İçerikte Bulunmamaktadır...

▲ : Not included in the set

▲ : Non inclus dans la pochette

00: Motor Takım Keçesiz ve Subap Lastiksiz











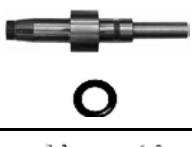
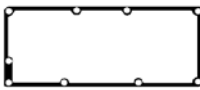











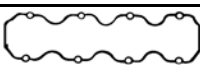



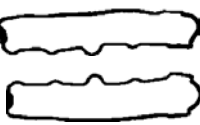
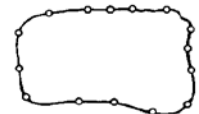

00: Gasket Set Without oil seals Without Valve Stem Seal

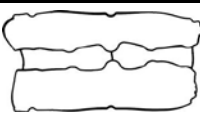
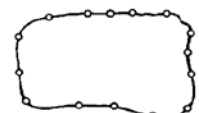
01: Motor Takım Keçesiz - Subap Lastikli

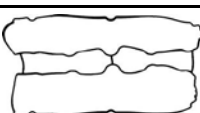
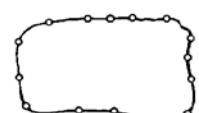
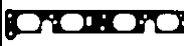
01: Gasket set With Valve Stem Seal Without Oil Seals

02: Motor Full Takım Keçeli ve Subap Lastikli

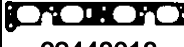
02: Gasket Full Set With oil seals and Valve Stem Seals

Subap Kapak Valve Cover Gasket Zylinderkopfhaube Couvre-culbut.	Karter Oil Pan Ölwanne Carter d'huile	Emme Manifold Intake Manifold Ansaug Admission	Egzoz Manifold Exhaust Manifold Auspuffkrümmer Collecteur D'échappement	Eksoz Boğaz Exhaust Pipe Auspuff Kehle	Supap Keçesi Valve Stem Seal Ventilschaft Queue de soupape	
						
62447235 638 727	62447265 652 577	62447219 850 634	62447221 850 615	62447517 854933	62447227x8 642527 7x11,1/16x10	21201014 35x48x7 RD
						21208013 80x98x10 LD
62447236 638 260 Kauçuk Rubber	62447265 652 577	62447319 850 607	62447221 850 615	62447517 854933	62447227x8 642527 7x11,1/16x10	21208007 26x42x8 RD
						21201014 35x48x7 RD
62447435 638736+638737	62447465 652669	62447819 850668	62447421 5850613			21208013 80x98x10 LD
					62447426x16 642533 6x8.8x12.2x9.7	21208007 26x42x8 RD
62448025 638742	62447465 652669	62447818 5850615				21201014x2 35x48x7 RD
		62448019 849196	62447421 5850613			21208013 80x98x10 LD
			62448018 5850624		62447426x16 642533 6x8.8x12.2x9.7	21208007 26x42x8 RD
62448025 638742	62447465 652669	62448019 849196	62448021 850510			21201014x2 35x48x7 RD
			62448018 5850624		62447426x16 642533 6x8.8x12.2x9.7	21208013 80x98x10 LD
						21208007 26x42x8 RD

■ : Delik - Çentik

■ : Hole - Notch

■ : Trou - Entaille

NOT: Katalogdaki Orijinal Kodlar Referans Amacıyla Kullanılmıştır.Lütfen Oto Conta Kodlarını Kullanınız.
Original codes used for reference only.Please use OTO CONTA codes for orders.

00



01



02



03



04



Silindir Kapak
Cylinder Head
Zylinderkopf
Joint de culasse

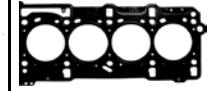

Ltr	MODEL	PS/KW	ENGINE/MOTOR		
1,6 1598	4 CYL ø79 CORSA B 01/94-->12/00 TIGRA CORSA B 03/93-->09/00 (DOCH 16V)	106 PS / 78 KW 100 PS / 74 KW 109 PS / 80 KW	C 16 SEL X 16 XE C 16 XE	62447402 1606820+1606790 62447403 1606820 62447404 1606790	 62447405 607491 1,40mm ø80,5
1,6 1598	4 CYL ø79 ASCONA C 09/84-->05/93 CORSA A KADETT E VECTRA A ASTRA F 02/93-->02/98 VECTRA A ASTRA F 09/91--> ASTRA G VECTRA B (OHC)	102 PS / 75 KW 82 PS / 60 KW 71 PS / 52 KW 75 PS / 55 KW	E 16 SE 16SV X 16 SZ X 16 SZR 16 NZR	62447302 1606689+1606686 62447303 1606689-1606673 62447204 1606686	 62447305 5607408-607988 1,40mm ø80,5
1,6 1598	4 CYL ø79 ASTRA F 01/94-->01/05 VECTRA B (DOCH 16V)	101 PS / 74 KW 100 PS / 74 KW	X 16 XEL	62447402 1606820+1606790 62447403 1606820-1606819 62447404 1606790	 62447405 607491 1,40mm ø80,5
1,6 1598	4 CYL ø79 ASTRA G 10/95--> VECTRA B ZAFIRA (DOCH 16V)	101 PS / 74 KW 100 PS / 74 KW	X 16 XEL	62448502 1606380+1606790 62448503 1606380 62447404 1606790	 62447405 607491 1,40mm ø80,5
1,6 1598	4 CYL ø79 VECTRA B 10/95-->07/02 (DOCH 16V)	101 PS / 74 KW 100 PS / 74 KW	Y 16 XE	62448303 1606130 62447404 1606790	 62448305 607407 ø80 MLS

▲ : İçerikte Bulunmamaktadır...

▲ : Not included in the set

▲ : Non inclus dans la pochette

00: Motor Takım Keçesiz ve Subap Lastiksiz











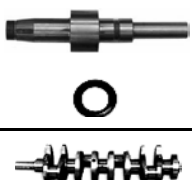
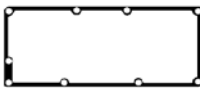





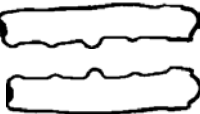
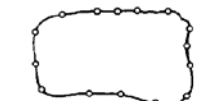









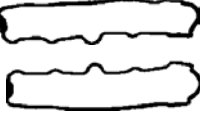
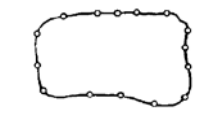



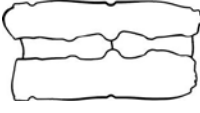

00: Gasket Set Without oil seals Without Valve Stem Seal

01: Motor Takım Keçesiz - Subap Lastikli

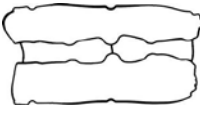
01: Gasket set With Valve Stem Seal Without Oil Seals

02: Motor Full Takım Keçeli ve Subap Lastikli

02: Gasket Full Set With oil seals and Valve Stem Seals

Subap Kapak Valve Cover Gasket Zylinderkopfhaube Couvre-culbut.	Karter Oil Pan Ölwanne Carter d'huile	Emme Manifold Intake Manifold Ansaug Admission	Egzoz Manifold Exhaust Manifold Auspuffkrümmer Collecteur D'échappement	Eksoz Boğaz Exhaust Pipe Auspuff Kehle	Supap Keçesi Valve Stem Seal Ventilschaft Queue de soupape	
						
 62447435 638736+638737	 62447465 652669	 62447819 850668  62447818 5850615	 62447421 5850613		 62447426x16 642533 6x8.8x12.2x9.7	21201014x2 35x48x7 RD 21208013 80x98x10 LD 21208007 26x42x8 RD
 62447235 638 727	 62447265 652 577	 62447219 850 634	 62447221 850 615	 62447517 854933	 62447227x8 642527 7x11,1/16x10	21201014 35x48x7 RD 21208013 80x98x10 LD 21208007 26x42x8 RD
 62447435 638736+638737	 62447465 652669	 62447819 850668  62447818 5850615	 62447421 5850613		 62447426x16 642533 6x8.8x12.2x9.7	21201014x2 35x48x7 RD 21208013 80x98x10 LD 21208007 26x42x8 RD
 62448025 638742	 62447465 652669	 62448019 849196  62448018 5850624	 62447421 5850613		 62447426x16 642533 6x8.8x12.2x9.7	21201014x2 35x48x7 RD 21208013 80x98x10 LD 21208007 26x42x8 RD
 62448025 638742	 62447465 652669	 62448019 849196  62448018 5850624	 62448021 850510		 62447426x16 642533 6x8.8x12.2x9.7	21201014x2 35x48x7 RD 21208013 80x98x10 LD 21208007 26x42x8 RD

■ : Delik - Çentik

■ : Hole - Notch

■ : Trou - Entaille

NOT: Katalogdaki Orijinal Kodlar Referans Amacıyla Kullanılmıştır.Lütfen Oto Conta Kodlarını Kullanınız.
Original codes used for reference only.Please use OTO CONTA codes for orders.

00



Silindir Kapak
Cylinder Head

01



Zylinderkopf

02



Joint de culasse

03



04

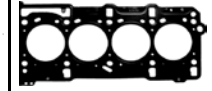

Ltr	MODEL	PS/KW	ENGINE/MOTOR		
1,6 1598	4 CYL ø79 ASTRA H Turbo 09/05--> ASTRA J ASTRA J Turbo ASTRA S T TURBO CORSA D Turbo INSIGNIA Turbo MERIVA Turbo ZAFIRA ZAFIRA Turbo ASTRA H 12/06--> ASTRA J ASTRA S T INSIGNIA ZAFIRA (DOCH 16V)	211 PS / 155 KW 150 PS / 110 KW 116 PS / 85 KW 115 PS / 85 KW	A 16 LEL A 16 LER A 16 LET A 16 XNT Z 16 LEL Z 16 LER Z 16 LET Z 16 XNT A 16 XER Z 16 XER		 61417005 71744395 1,20mm FIBER / FIBRE 61417006 71744395 1,80mm FIBER / FIBRE ø82
1,6 1598	4 CYL ø79 ASCONA C 08/86-->09/98 ASTRA F CORSA A KADETT E VECTRA A (OHC)	75 PS / 55 KW	C 16 NZ E 16 NZ	62447302 1606689+1606686 62447303 1606689 62447204 1606686	 62447305 5607408-607988 1,40mm ø80,5
1,6 1598	4 CYL ø79 ASTRA F 03/91-->02/98 CORSA A 02/92-->03/93 (OHC)	100 PS / 74 KW 101 PS / 74 KW	C 16 SE C 16 SE	62447002 1606729+1606728 62447003 1606729 62447204 1606686	 62447305 5607408-607988 1,40mm ø80,5
1,6 1598	4 CYL ø79 ASTRA G 02/98-->06/05 ZAFIRA (DOCH 16V)	101 PS / 74 KW	C 16 SEL	62448502 1606380+1606790 62448503 1606380 62447404 1606790	 62447405 607491 1,40mm ø80,5

▲ : İçerikte Bulunmamaktadır...

▲ : Not included in the set

▲ : Non inclus dans la pochette

00: Motor Takım Keçesiz ve Subap Lastiksiz











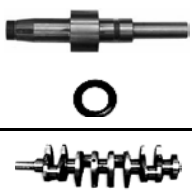
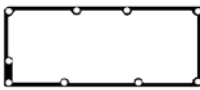









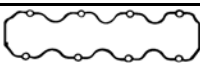

00: Gasket Set Without oil seals Without Valve Stem Seal

01: Motor Takım Keçesiz - Subap Lastikli

01: Gasket set With Valve Stem Seal Without Oil Seals

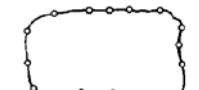
02: Motor Full Takım Keçeli ve Subap Lastikli

02: Gasket Full Set With oil seals and Valve Stem Seals

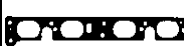
Subap Kapak Valve Cover Gasket Zylinderkopfhaube Couvre-culbut.	Karter Oil Pan Ölwanne Carter d'huile	Emme Manifold Intake Manifold Ansaug Admission	Egzoz Manifold Exhaust Manifold Auspuffkrümmer Collecteur D'echappement	Eksoz Boğaz Exhaust Pipe Auspuff Kehle	Supap Keçesi Valve Stem Seal Ventilschaft Queue de soupape	
						
						21201014 35x48x7 RD
62447235 638 727	62447265 652 577	62447219 850 634	62447221 850 615	62447517 854933	62447227x8 642527 7x11,1/16x10	21208013 80x98x10 LD
						21201014 35x48x7 RD
62447236 638 260 Kauçuk Rubber	62447265 652 577	62447319 850 607	62447221 850 615	62447517 854933	62447227x8 642527 7x11,1/16x10	21208013 80x98x10 LD
						21201014x2 35x48x7 RD
62448025 638742	62447465 652669	62448019 849196  62448018 5850624	62447421 5850613		62447426x16 642533 6x8.8x12.2x9.7	21208013 80x98x10 LD
						21208007 26x42x8 RD

■ : Delik - Çentik

■ : Hole - Notch

■ : Trou - Entaille

NOT: Katalogdaki Orijinal Kodlar Referans Amacıyla Kullanılmıştır.Lütfen COTECH Kodlarını Kullanınız.
Original codes used for reference only.Please use COTECH codes for orders.

00



01



02



03



04



Silindir Kapak
Cylinder Head
Zylinderkopf
Joint de culasse

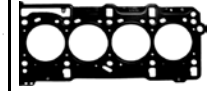

Ltr	MODEL	PS/KW	ENGINE/MOTOR		
1,6 1598	4 CYL ø79 ASTRA G 09/01--> ASTRA G CNG ASTRA H COMBO CNG CORSA C ZAFIRA ZAFIRA CNG (DOCH 16V)	97 PS / 71 KW 92 PS / 69 KW	Y 16 YNG Z 16 YNG	62448303 1606130	 62448305 607407 ø80 MLS
1,6 1598	4 CYL ø79 ASTRA G 10/95--> MERIVA VECTRA B VECTRA C ZAFIRA (DOCH 16V)	101 PS / 74 KW 100 PS / 74 KW	Z 16 XE	62448303 1606130 62448004 1606170	 62448305 607407 ø80 MLS
1,8 1796	4 CYL ø79 ASTRA H 01/04--> INSIGNIA SIGNUM VECTRA C ZAFIRA (DOCH 16V)	140 PS / 103 KW	A 18 XER Z 18 XER		 61417005 71744395 1,20mm FIBER / FIBRE 61417006 71744395 1,80mm FIBER / FIBRE ø82
1,8 1796	4 CYL ø84,8 ASCONA C 08/84-->09/92 KADETT E ASCONA C 01/85-->09/98 ASTRA F KADETT E OMEGA A VECTRA A (OHC)	100 PS / 74 KW 90 PS / 66 KW 100 PS / 74 KW 82 PS / 60 KW	C 18 NE C 18 NT C 18 NZ E 18 NV E 18 NVR S 18 NV 18 NV 18 SV	62447502 62447503+62447504 62447503 1606682-1606666 62447504 1606663	 62447505 607986 1,40mm ø86,3
1,8 1796	4 CYL ø81,6 VECTRA B 10/95-->09/00 (DOCH 16V)	116 PS / 85 KW 115 PS / 85 KW	X 18 XE	62448603 1606914	 62448605 608809 1,40mm ø83

▲ : İçerikte Bulunmamaktadır...

▲ : Not included in the set

▲ : Non inclus dans la pochette

00: Motor Takım Keçesiz ve Subap Lastiksiz











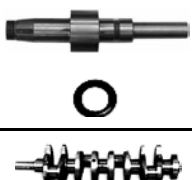
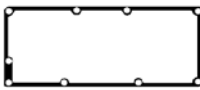





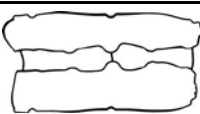



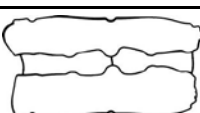
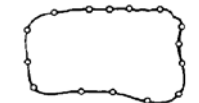



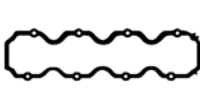

00: Gasket Set Without oil seals Without Valve Stem Seal

01: Motor Takım Keçesiz - Subap Lastikli

01: Gasket set With Valve Stem Seal Without Oil Seals

02: Motor Full Takım Keçeli ve Subap Lastikli

02: Gasket Full Set With oil seals and Valve Stem Seals

Subap Kapak Valve Cover Gasket Zylinderkopfhaube Couvre-culbut.	Karter Oil Pan Ölwanne Carter d'huile	Emme Manifold Intake Manifold Ansaug Admission	Egzoz Manifold Exhaust Manifold Auspuffkrümmer Collecteur D'echappement	Eksoz Boğaz Exhaust Pipe Auspuff Kehle	Supap Keçesi Valve Stem Seal Ventilschaft Queue de soupape	
						
 62448025 638742		 62448019 849196  62448018 5850624	 62448021 850510		 62447426x16 642533 6x8.8x12.2x9.7	21201014x2 35x48x7 RD
 62448025 638742	 62447465 652669	 62448019 849196  62448018 5850624	 62448021 850510		 62447426x16 642533 6x8.8x12.2x9.7	21201014x2 35x48x7 RD 21208013 80x98x10 LD 21208007 26x42x8 RD
 62447534 638192	 62447564 652587	 62447518 850600  62447719 850601	 62447521 850645	 62447517 854933	 62447227x8 642527 7x11,1/16x10	21201014 35x48x7 RD 21208020 31x50x8 RD 21208019 90x104x11 LD
 62447625 607647		 62447619 850655	 62447621 850656	 62447517 854933	 62447426x16 642533 6x8.8x12.2x9.7	21201014x2 35x48x7 RD

■ : Delik - Çentik

■ : Hole - Notch

■ : Trou - Entaille

NOT: Katalogdaki Orijinal Kodlar Referans Amacıyla Kullanılmıştır.Lütfen COTECH Kodlarını Kullanınız.
Original codes used for reference only.Please use COTECH codes for orders.

00



Silindir Kapak
Cylinder Head

01



Zylinderkopf

02



Joint de culasse

03



04

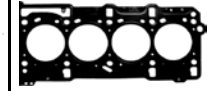

Ltr	MODEL	PS/KW	ENGINE/MOTOR		
1,8 1796	4 CYL ø81,6 ASTRA F 06/93-->03/01 ASTRA F 07/94-->03/01 (DOCH 16V)	125 PS / 92 KW 115 PS / 85 KW 116 PS / 85 KW	C 18 XE C 18 XEL X 18 XE		 62448605 608809 1,40mm ø83
1,8 1796	4 CYL ø80,5 ASTRA F 02/98-->10/00 ASTRA G 04/02--> VECTRA C ZAFIRA VECTRA B 10/95-->07/03 ASTRA G 09/00--> ASTRA H CORSA C MERIVA SIGNUM TIGRA VECTRA C ZAFIRA (DOCH 16V)	116 PS / 85 KW 110 PS / 81 KW 125 PS / 92 KW 115 PS / 85 KW 125 PS / 92 KW 122 PS / 90 KW	X 18 XE1 Z 18 XEL X 18 XE1 Z 18 XE Z 18 XE		 62448205 5607858 MLS ø81,5
1,8 1796	4 CYL ø84,8 ASTRA F 09/81-->02/98 OMEGA A 09/86-->03/94 (OHC)	116 PS / 85 KW 111 PS / 82 KW 115 PS / 85 KW	18 SE 18 SEH	62447502 62447503+62447504 62447503 1606682-1606666 62447504 1606663	 62447505 607986 1,40mm ø86,3
1,9 1870	4 CYL ø80 ARENA D 03/98-->08/01	60 PS / 44 KW	F8Q 600 F8Q 606		 60152005 44 01 561 1,60mm 3 60152006 44 01 518 1,50mm 1 60152007 44 01 560 1,40mm 2 ø81

▲ : İçerikte Bulunmamaktadır...

▲ : Not included in the set

▲ : Non inclus dans la pochette

00: Motor Takım Keçesiz ve Subap Lastiksiz











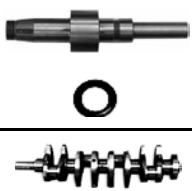
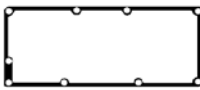

00: Gasket Set Without oil seals Without Valve Stem Seal

01: Motor Takım Keçesiz - Subap Lastikli

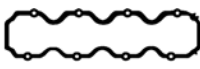
01: Gasket set With Valve Stem Seal Without Oil Seals

02: Motor Full Takım Keçeli ve Subap Lastikli

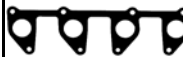
02: Gasket Full Set With oil seals and Valve Stem Seals

Subap Kapak Valve Cover Gasket Zylinderkopfhaube Couvre-culbut.	Karter Oil Pan Ölwanne Carter d'huile	Emme Manifold Intake Manifold Ansaug Admission	Egzoz Manifold Exhaust Manifold Auspuffkrümmer Collecteur D'echappement	Eksoz Boğaz Exhaust Pipe Auspuff Kehle	Supap Keçesi Valve Stem Seal Ventilschaft Queue de soupape	
						
 62447534 638192	 62447564 652587	 62447518 850600  62447719 850601	 62447521 850645	 62447517 854933	 62447227x8 642527 7x11,1/16x10	21201014 35x48x7 RD 21208020 31x50x8 RD 21208019 90x104x11 LD

 : Delik - Çentik

 : Hole - Notch

 : Trou - Entaille

NOT: Katalogdaki Orijinal Kodlar Referans Amacıyla Kullanılmıştır.Lütfen COTECH Kodlarını Kullanınız.
Original codes used for reference only.Please use COTECH codes for orders.

00



01



02



03









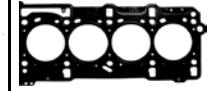





04



Silindir Kapak
Cylinder Head
Zylinderkopf
Joint de culasse



Ltr	MODEL	PS/KW	ENGINE/MOTOR		
1,9 1870	4 CYL ø80 MOVANO DTI 09/00-->	82 PS / 60 KW 80 PS / 59 KW	F9Q 770 F9Q 772	<p>60152102 Motor Full Takım Gasket Full Set </p> <p>60152103 44 02 544 </p> <p>60152104 77 01 470 176</p>	<p> 60152105 44 02 582 1,45mm 1 </p> <p>60152106 44 02 581 1,35mm 2 </p> <p>60152107 44 02 583 1,55mm 3 </p> <p>ø81</p>
1,9 1910	4 CYL ø82 ASTRA H CDTI 01/04--> SIGNUM CDTI VECTRA C CDTI ZAFIRA CDTI	120 PS / 88 KW 100 PS / 74 KW	Z 19 DT Z 19 DTL	<p>62427802 Motor Full Takım Gasket Full Set </p> <p>62427803 16 06 329 </p> <p>62427704 16 06 336</p>	<p> 62427805 56 07 843 0,82mm ø83</p> <p>62427806 56 07 845 0,92mm 1 </p> <p>ø83</p> <p>62427807 56 07 847 1,02mm 2 </p> <p>MLS ø83</p>
2,0 1998	4 CYL ø86 ASCONA C 09/86-->09/98 ASTRA F CALIBRA A KADETT E OMEGA A VECTRA A (OHC)	130 PS / 95 KW 99 PS 73 KW	C 20 NE C 20 NEF C 20 NEJ 20 NE 20 SEH 20 SER	<p>62447700</p> <p>62447702 1606664+1606663</p> <p>62447703 1606664</p> <p>62447504 1606663</p>	<p> 62447705 607987 1,30mm ø87,5</p>

▲ : İçerikte Bulunmamaktadır...

▲ : Not included in the set

▲ : Non inclus dans la pochette

00: Motor Takım Keçesiz ve Subap Lastiksiz











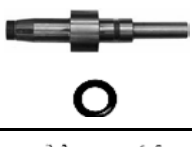
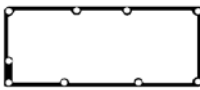









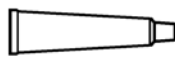

00: Gasket Set Without oil seals Without Valve Stem Seal

01: Motor Takım Keçesiz - Subap Lastikli

01: Gasket set With Valve Stem Seal Without Oil Seals

02: Motor Full Takım Keçeli ve Subap Lastikli

02: Gasket Full Set With oil seals and Valve Stem Seals

Subap Kapak Valve Cover Gasket Zylinderkopfhaube Couvre-culbut.	Karter Oil Pan Ölwanne Carter d'huile	Emme Manifold Intake Manifold Ansaug Admission	Egzoz Manifold Exhaust Manifold Auspuffkrümmer Collecteur D'echappement	Eksoz Boğaz Exhaust Pipe Auspuff Kehle	Supap Keçesi Valve Stem Seal Ventilschaft Queue de soupape	
						
 60152025 44 08 006	 60152065 44 02 981	 60152121 44 02 641			 60116026x8 44 12 186 7x9,8/13,2x10	21204002 25x42x8 RD
 62427825 56 07 853	 62427465	 62427820 58 50 828	 62427721 58 49 907		 60107027x8 44 01 804 8x10,8/14,2x10	21208003 30x42x7 RD
 62427826 56 07 165						21201100 31x41x7 RD
 62447534 638192	 62447564 652587	 62447719 850601	 62447521 850645	 62447517 854933	 62447227x8 642527 7x11,1/16x10	21201014 35x48x7 RD
						21208020 31x50x8 RD
						21208019 90x104x11 LD

■ : Delik - Çentik

■ : Hole - Notch

■ : Trou - Entaille

NOT: Katalogdaki Orijinal Kodlar Referans Amacıyla Kullanılmıştır.Lütfen COTECH Kodlarını Kullanınız.
Original codes used for reference only.Please use COTECH codes for orders.

00



01



02



03



04



Silindir Kapak
Cylinder Head
Zylinderkopf
Joint de culasse

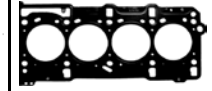

Ltr	MODEL	PS/KW	ENGINE/MOTOR		
2,0 1998	4 CYL ø82,7 VIVARO 08/01--> VIVARO 08/06-->	120 PS 88 KW 117 PS / 86 KW	F4R 720 F4R 820		 62457305 77 00 108 254 MLS ø84
2,0 1998	4 CYL ø86 FRONTERA A 03/92-->10/98 OMEGA B 03/94-->09/99 (OHC)	115 PS / 85 KW 116 PS / 85 KW	X 20 SE X 20 SE		 62447705 607987 1,30mm ø87,5
2,0 1998	4 CYL ø86 ASTRA G 11/99-->09/02 (DOCH 16V)	160 PS / 118 KW	X 20 XER	62447603 1606770	 62447605 5607409 1,30mm ø87,5
2,0 1998	4 CYL ø86 ASTRA F 01/94-->01/98 ASTRA G CALIBRA A OMEGA B VECTRA A VECTRA B (DOCH 16V)	136 PS / 100 KW	X 20 XEV	62447603 1606770	 62447605 5607409 1,30mm ø87,5
2,0 1998	4 CYL ø86 VECTRA B 10/95-->04/02 OMEGA B 03/94-->12/00 (OHC)	112 PS / 82 KW 115 PS / 85 KW	20 NEJ 20 SE		 62447705 607987 1,30mm ø87,5

▲ : İçerikte Bulunmamaktadır...

▲ : Not included in the set

▲ : Non inclus dans la pochette

00: Motor Takım Keçesiz ve Subap Lastiksiz











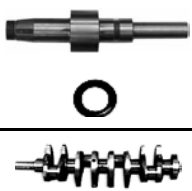
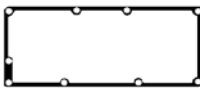



00: Gasket Set Without oil seals Without Valve Stem Seal

01: Motor Takım Keçesiz - Subap Lastikli

01: Gasket set With Valve Stem Seal Without Oil Seals

02: Motor Full Takım Keçeli ve Subap Lastikli

02: Gasket Full Set With oil seals and Valve Stem Seals

Subap Kapak Valve Cover Gasket Zylinderkopfhaube Couvre-culbut.	Karter Oil Pan Ölwanne Carter d'huile	Emme Manifold Intake Manifold Ansaug Admission	Egzoz Manifold Exhaust Manifold Auspuffkrümmer Collecteur D'echappement	Eksoz Boğaz Exhaust Pipe Auspuff Kehle	Supap Keçesi Valve Stem Seal Ventilschaft Queue de soupape	
						
 62447625 607647		 62447619 850655	 62447621 850656		 62447426x16 642533 6x8.8x12.2x9.7	21201014x2 35x48x7 RD
 62447625 607647		 62447619 850655	 62447621 850656		 62447426x16 642533 6x8.8x12.2x9.7	21201014x2 35x48x7 RD

 : Delik - Çentik

 : Hole - Notch

 : Trou - Entaille

NOT: Katalogdaki Orijinal Kodlar Referans Amacıyla Kullanılmıştır.Lütfen COTECH Kodlarını Kullanınız.
Original codes used for reference only.Please use COTECH codes for orders.

00



01



02



03



04



Silindir Kapak
Cylinder Head
Zylinderkopf
Joint de culasse

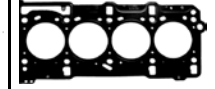

Ltr	MODEL	PS/KW	ENGINE/MOTOR		
2,0 1998	4 CYL ø86 OMEGA A (OHC) 09/86-->03/94	122 PS / 90 KW	20 SE	62447700 62447702 1606664+1606663 62447703 1606664 62447504 1606663	 62447705 607987 1,30mm ø87,5
2,2 2198	4 CYL ø86 VECTRA B (DOCH 16V) 09/00-->07/03	147 PS / 108 KW	C 22 SEL	62447603 1606770	 62447605 5607409 1,30mm ø87,5
2,2 2198	4 CYL ø86 FRONTERA B 10/98--> FRONTERA A 03/95-->10/98 SINTRA 11/96-->04/99 OMEGA B 09/99-->07/03 (DOCH 16V)	136 PS / 100 KW 136 PS / 100 KW 141 PS / 104 KW 144 PS / 104 KW	X 22 SE Y 22 SE X 22 SE X 22 XE Y 22 XE Z 22 XE		 62447605 5607409 1,30mm ø87,5

▲ : İçerikte Bulunmamaktadır...

▲ : Not included in the set

▲ : Non inclus dans la pochette

00: Motor Takım Keçesiz ve Subap Lastiksiz











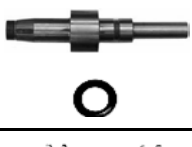

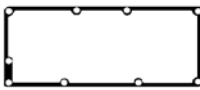

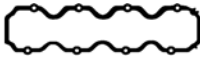

00: Gasket Set Without oil seals Without Valve Stem Seal

01: Motor Takım Keçesiz - Subap Lastikli

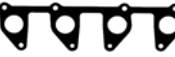
01: Gasket set With Valve Stem Seal Without Oil Seals

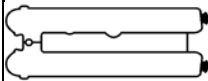
02: Motor Full Takım Keçeli ve Subap Lastikli

02: Gasket Full Set With oil seals and Valve Stem Seals

Subap Kapak Valve Cover Gasket Zylinderkopfhaube Couvre-culbut.	Karter Oil Pan Ölwanne Carter d'huile	Emme Manifold Intake Manifold Ansaug Admission	Egzoz Manifold Exhaust Manifold Auspuffkrümmer Collecteur D'echappement	Eksoz Boğaz Exhaust Pipe Auspuff Kehle	Supap Keçesi Valve Stem Seal Ventilschaft Queue de soupape	 
						
 62447534 638192	 62447564 652587	 62447719 850601	 62447521 850645	 62447517 854933	 62447227x8 642527 7x11,1/16x10	21201014 35x48x7 RD
 62447625 607647		 62447619 850655	 62447621 850656		 62447426x16 642533 6x8.8x12.2x9.7	21208020 31x50x8 RD
						21208019 90x104x11 LD
						21201014x2 35x48x7 RD

 : Delik - Çentik

 : Hole - Notch

 : Trou - Entaille

NOT: Katalogdaki Orijinal Kodlar Referans Amacıyla Kullanılmıştır.Lütfen COTECH Kodlarını Kullanınız.
Original codes used for reference only.Please use COTECH codes for orders.

00



Silindir Kapak
Cylinder Head

01



Zylinderkopf

02



Joint de culasse

03



04



Ltr	MODEL	PS/KW	ENGINE/MOTOR		
1,0 954	4 CYL ø70 104 205 10/72-->10/83	46 PS / 34 KW 45 PS / 33 KW	XV3 (108) XV5(108)	61216002 198,57	 61216005 0203.84 1,20mm Loc ø16mm 61216006 0203.22 1,40mm ø74
1,0 954	4 CYL ø70 106 205 10/87-->	50 PS / 37 KW 45 PS / 33 KW	TU9 TU9M (CDY) TU9M (CDZ)	61221002 Motor Full Takım Gasket Full Set 61221003 0197.H8+0209.89 61209004 0197.H9	 61221005 0209.89 1,30mm 1 61221006 0209.90 1,50mm 2 ø73,5
1,0 999	4 CYL ø69 206 16V (DOCH) 2000-->	75 PS / 55 KW	D4D	60108603 77 01 473 003	 60108605 8200062273 MLS ø70
1,1 1118	4 CYL ø74 309 10/85-->07/89	54 PS / 40 KW	E1		 61208005 0209.H9 1,20mm ø77
1,1 1124	4 CYL ø72 PARTNER 106 206 206 SW 05/96-->	60 PS / 44 KW	TU1JP (HFX) TU1JP (HFZ)		 61222005 0209.Y0 1,30mm 1 61222006 0209.Y1 1,50mm 2 ø74

▲ : İçerikte Bulunmamaktadır...

▲ : Not included in the set

▲ : Non inclus dans la pochette

00: Motor Takım Keçesiz ve Subap Lastiksiz

00: Gasket Set Without oil seals Without Valve Stem Seal











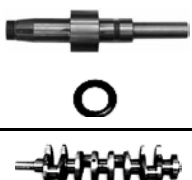
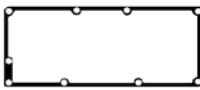





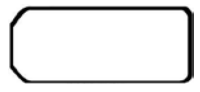
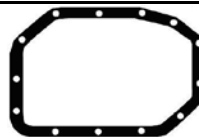



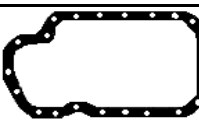

01: Motor Takım Keçesiz - Subap Lastikli

01: Gasket set With Valve Stem Seal Without Oil Seals

02: Motor Full Takım Keçeli ve Subap Lastikli

02: Gasket Full Set With oil seals and Valve Stem Seals

205

Subap Kapak Valve Cover Gasket Zylinderkopfhaube Couvre-culbut.	Karter Oil Pan Ölwanne Carter d'huile	Emme Manifold Intake Manifold Ansaug Admission	Egzoz Manifold Exhaust Manifold Auspuffkrümmer Collecteur D'echappement	Eksoz Boğaz Exhaust Pipe Auspuff Kehle	Supap Keçesi Valve Stem Seal Ventilschaft Queue de soupape	
						
 61201525 0249.39	 61201013 0304.46	 61201018 0384.54	 61201020 0349.16	 61205017 7700657683	 60107027x8 956,22 8x10.8/14.2x10	21201013 35x50x8 WD 21201033 78x100x10 LD
 61209025 0249.54	 61209013 0304.304	 61209019x2	 61209020x2 0349,A6	 61209017 1709.15	 60116026x8 0956.19 7x9,8/13.2x10	21201062 36x50x7 RD 21201021 42x66x6 RD 21204504 85x105x8 LD
 60108625 77 01 049 888	 62427465	 60108618 77 01 473 007	 60108621 77 00 115 971		 60108626x16 5,5x11x23x15,7	21204701 28x47x8 RD

 : Delik - Çentik

 : Hole - Notch

 : Trou - Entaille

NOT: Katalogdaki Orijinal Kodlar Referans Amacıyla Kullanılmıştır.Lütfen COTECH Kodlarını Kullanınız.
Original codes used for reference only.Please use COTECH codes for orders.

00



01



02



03



04



Silindir Kapak
Cylinder Head
Zylinderkopf
Joint de culasse

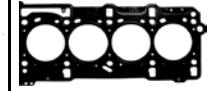

Ltr	MODEL	PS/KW	ENGINE/MOTOR		
1,1 1124	4 CYL ø72 PARTNER 09/96--> 106 306	60 PS / 44 KW	TU1M+ HDY (TU1M) HDZ(TU1M)	61221002 Motor Full Takım Gasket Full Set 61221003 0197.H8+0209.89 61209004 0197.H9	 61221005 0209.89 1,30mm 1 61221006 0209.90 1,50mm 2 ø73,5
1,1 1124	4 CYL ø75 PARTNER 09/91--> 106 306 205 07/89-->09/98 309	60 PS / 44 KW 54 PS / 40 KW 60 PS / 44 KW	TU1M (HDY) TU1M (HDZ) TU1M (HDZ)	61209002 Motor Full Takım Gasket Full Set 61209003 0197.H8+0209.CJ 61209004 0197.H9	 61209005 0209.CJ 1,30mm 1 61209006 0209.W6 - W7 1,50 mm 2 ø76
1,1 1127	4 CYL ø78 204 09/75-->12/88 304 305	58 PS / 43 KW	XK5	61206002 0197.91	 61206005 0209.G7 1,30mm ø80,5
1,1 1130	4 CYL ø75 204 10/65-->10/77	55 PS / 40 KW 53 PS / 39 KW	XK XK4	61205002 0199.58	 61205005 0199.75 1,20mm ø78
1,2 1204	4 CYL ø74 205 01/87-->12/90	64 PS / 47 KW	F1		 61208005 0209.H9 1,20mm ø77

▲ : İçerikte Bulunmamaktadır...

▲ : Not included in the set

▲ : Non inclus dans la pochette

00: Motor Takım Keçesiz ve Subap Lastiksiz











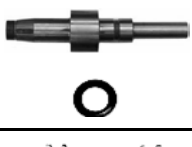
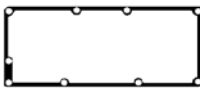









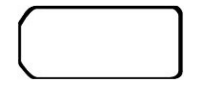
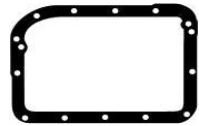

00: Gasket Set Without oil seals Without Valve Stem Seal

01: Motor Takım Keçesiz - Subap Lastikli

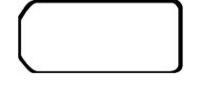
01: Gasket set With Valve Stem Seal Without Oil Seals

02: Motor Full Takım Keçeli ve Subap Lastikli

02: Gasket Full Set With oil seals and Valve Stem Seals

Subap Kapak Valve Cover Gasket Zylinderkopfhaube Couvre-culbut.	Karter Oil Pan Ölwanne Carter d'huile	Emme Manifold Intake Manifold Ansaug Admission	Egzoz Manifold Exhaust Manifold Auspuffkrümmer Collecteur D'echappement	Eksoz Boğaz Exhaust Pipe Auspuff Kehle	Supap Keçesi Valve Stem Seal Ventilschaft Queue de soupape	
						
61209025 0249.54	61209013 0304.304	61209019x2	61209020x2 0349,A6	61209017 1709.15	60116026x8 0956.19 7x9,8/13.2x10	21201062 36x50x7 RD
						21201021 42x66x6 RD
						21204504 85x105x8 LD
						21201062 36x50x7 RD
61209025 0249.54	61209013 0304.304	61209019x2	61209020x2 0349,A6	61209017 1709.15	60116026x8 0956.19 7x9,8/13.2x10	21201021 42x66x6 RD
						21204504 85x105x8 LD
						21201018 40x49,6x7.3 LD
61205025 0249.21	61205013 0304.09	61205020 0349.23		61205017 1710.09		21201029 60,5x78x9 RD
						
				61205018 1710.11		
						21201018 40x49,6x7.3 LD
61205025 0249.21	61205013 0304.09	61205020 0349.23		61205017 1710.09		21201029 60,5x78x9 RD
						
				61205018 1710.11		

 : Delik - Çentik

 : Hole - Notch

 : Trou - Entaille

NOT: Katalogdaki Orijinal Kodlar Referans Amacıyla Kullanılmıştır.Lütfen COTECH Kodlarını Kullanınız.
Original codes used for reference only.Please use COTECH codes for orders.

00



01



02



03



04



Silindir Kapak
Cylinder Head
Zylinderkopf
Joint de culasse



Ltr	MODEL	PS/KW	ENGINE/MOTOR		
1,3 1290	4 CYL ø78 304 09/70-->10/80 305 11/77-->08/86	75 PS / 55 KW 65 PS / 48 KW 60 PS / 44 KW	118(XL5) XL5 XL5S	61206002 0197.91	 61206005 0209.G7 1,30mm ø80,5
1,3 1290	4 CYL ø75 304 10/69-->07/76	75 PS / 55 KW 65 PS / 48 KW	XL3 XL3S	61205002 0199.58	 61205005 0199.75 1,20mm ø78
1,3 1294	4 CYL ø75 205 RALLYE 10/87-->10/90	101 PS / 74 KW	TU24	61209002 Motor Full Takım Gasket Full Set 61209003 0197.H8+0209.CJ 61209004 0197.H9	 61209005 0209.CJ 1,30mm 1 61209006 0209.W6 - W7 1,50 mm 2 ø76
1,4 1360	4 CYL ø75 205 02/83-->10/87	60 PS / 44 KW 79 PS / 58 KW 80 PS / 59 KW	150(XY6B) 150B(XY8) 150D(XY7) 150G(XY7) 150H(XY8)	61201002 0197.77	 61201005 0209.A6 1,30mm Loc 14mm ø76
1,4 1360	4 CYL ø75 PARTNER 07/88--> 1007 106 205 206 206 SW 306 307	75 PS / 55 KW	KFV (TU3JP) KDX(TU3MC)	61209002 Motor Full Takım Gasket Full Set 61209003 0197.H8+0209.CJ 61209004 0197.H9	 61209005 0209.CJ 1,30mm 1 61209006 0209.W6 - W7 1,50 mm 2 ø76

▲ : İçerikte Bulunmamaktadır...

▲ : Not included in the set

▲ : Non inclus dans la pochette

00: Motor Takım Keçesiz ve Subap Lastiksiz











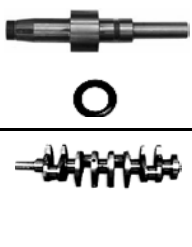
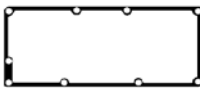







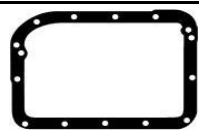



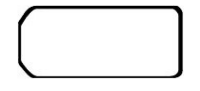
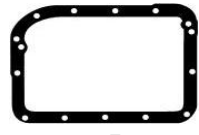



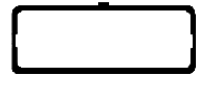







00: Gasket Set Without oil seals Without Valve Stem Seal

01: Motor Takım Keçesiz - Subap Lastikli

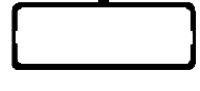
01: Gasket set With Valve Stem Seal Without Oil Seals

02: Motor Full Takım Keçeli ve Subap Lastikli

02: Gasket Full Set With oil seals and Valve Stem Seals

Subap Kapak Valve Cover Gasket Zylinderkopfhaube Couvre-culbut.	Karter Oil Pan Ölwanne Carter d'huile	Emme Manifold Intake Manifold Ansaug Admission	Egzoz Manifold Exhaust Manifold Auspuffkrümmer Collecteur D'échappement	Eksoz Boğaz Exhaust Pipe Auspuff Kehle	Supap Keçesi Valve Stem Seal Ventilschaft Queue de soupape	
						
 61205025 0249.21	 61205013 0304.09	 61205020 0349.23		 61205017 1710.09  61205018 1710.11		21201018 40x49,6x7.3 LD 21201029 60,5x78x9 RD
 61205025 0249.21	 61205013 0304.09	 61205020 0349.23		 61205017 1710.09  61205018 1710.11		21201018 40x49,6x7.3 LD 21201029 60,5x78x9 RD
 61209025 0249.54	 61209013 0304.304	 61209019x2	 61209020x2 0349,A6	 61209017 1709.15	 60116026x8 0956.19 7x9,8/13.2x10	21201062 36x50x7 RD 21201021 42x66x6 RD 21204504 85x105x8 LD
 61201525 0249.39	 61201013 0304.46	 61201018 0384.54	 61201020 0349.16	 61205017 7700657683	 60107027x8 956,22 8x10.8/14.2x10	21201013 35x50x8 WD 21201033 78x100x10 LD
 61209025 0249.54	 61209013 0304.304	 61209019x2	 61209020x2 0349,A6	 61209017 1709.15	 60116026x8 0956.19 7x9,8/13.2x10	21201062 36x50x7 RD 21201021 42x66x6 RD 21204504 85x105x8 LD

■ : Delik - Çentik

■ : Hole - Notch

■ : Trou - Entaille

NOT: Katalogdaki Orijinal Kodlar Referans Amacıyla Kullanılmıştır.Lütfen COTECH Kodlarını Kullanınız.
Original codes used for reference only.Please use COTECH codes for orders.

00



01



02



03



04



Silindir Kapak
Cylinder Head
Zylinderkopf
Joint de culasse

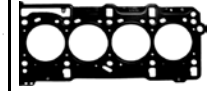

Ltr	MODEL	PS/KW	ENGINE/MOTOR		
1,4 1360	4 CYL ø75 PARTNER 01/87--> 106 205 306 309 405	84 PS / 62 KW 60 PS / 44 KW	TU 3 TU3A (K1D) TU3CP (KAY) TU3M (KDY) TU3M (KDZ) TU3MC (KDX) TU3S (K2B) TU3	61209002 Motor Full Takım Gasket Full Set 61209003 0197.H8+0209.CJ 61209004 0197.H9	 61209005 0209.CJ 1,30mm 1 61209006 0209.W6 - W7 1,50 mm 2 ø76
1,4 1360	4 CYL ø75 1007 16V 10/03--> 206 SW 16V 206 16V 207 307 SW 16V 307 16V	88 PS / 65 KW	ET3J4 (KFU)		 62190005 0209.CH 0209.FL 1,40mm ø76
1,4 1398	4 CYL ø74 1007 HDI 09/01--> 206 HDI 206 SW HDI 207 HDI 307 HDi 307 HDI	68 PS / 50 KW	DV4TD (8HX) DV4TD (8HZ)	61706002 Motor Full Takım Gasket Full Set 61706003 Motor Üst Takım Gasket Head Set 61706004 Motor Alt Takım Conversion Set	 61706005 0209.AH 1,45mm 5 61706006 0209.AG 1,40mm 4 61706007 0209.AE 1,30mm 3 61706008 0209.AC 1,25mm 2 61706009 0209.AF 1,35mm 1 MLS ø75
1,5 1472	4 CYL ø78 305 11/79-->07/90	88 PS / 65 KW 68 PS / 50 KW	XR5 (142) XR5A (142) XR5S (117)	61206002 0197.91	 61206005 0209.G7 1,30mm ø80,5

▲ : İçerikte Bulunmamaktadır...

▲ : Not included in the set

▲ : Non inclus dans la pochette

00: Motor Takım Keçesiz ve Subap Lastiksiz











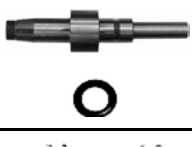
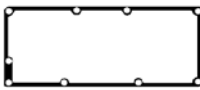









00: Gasket Set Without oil seals Without Valve Stem Seal

01: Motor Takım Keçesiz - Subap Lastikli

01: Gasket set With Valve Stem Seal Without Oil Seals

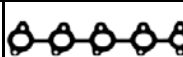
02: Motor Full Takım Keçeli ve Subap Lastikli

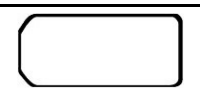
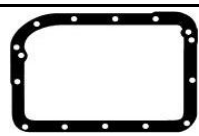
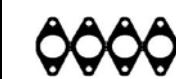
02: Gasket Full Set With oil seals and Valve Stem Seals

Subap Kapak Valve Cover Gasket Zylinderkopfhaube Couvre-culbut.	Karter Oil Pan Ölwanne Carter d'huile	Emme Manifold Intake Manifold Ansaug Admission	Egzoz Manifold Exhaust Manifold Auspuffkrümmer Collecteur D'échappement	Eksoz Boğaz Exhaust Pipe Auspuff Kehle	Supap Keçesi Valve Stem Seal Ventilschaft Queue de soupape	
						
						21201062 36x50x7 RD
61209025 0249.54	61209013 0304.304	61209019x2	61209020x2 0349,A6	61209017 1709.15	60116026x8 0956.19 7x9,8/13.2x10	21201021 42x66x6 RD
						21204504 85x105x8 LD
						21204017 27x47x7 RD
61706025 0249.C1 0249.F8	62427465	61706019x4 0348.R2 0348.T8	61706021 0349.J8 0349.J7		61706027x8 0956.50 5,5x9,5x22,9x17,5	21204018 40x55x6,4 LD
						21204019 85x105x8,8 RD
						21201018 40x49,6x7.3 LD
61205025 0249.21	61205013 0304.09	61205020 0349.23	61205018 1710.11	61205017 1710.09		21201029 60,5x78x9 RD

■ : Delik - Çentik

■ : Hole - Notch

■ : Trou - Entaille

NOT: Katalogdaki Orijinal Kodlar Referans Amacıyla Kullanılmıştır.Lütfen COTECH Kodlarını Kullanınız.
Original codes used for reference only.Please use COTECH codes for orders.

00



01



02



03









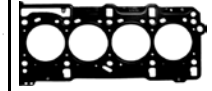



04



Silindir Kapak
Cylinder Head
Zylinderkopf
Joint de culasse



Ltr	MODEL	PS/KW	ENGINE/MOTOR		
1,6 1560	4 CYL ø75 EXPRESS TD 02/04--> PARTNER HDI 1007 HDI 206 CC HDI FAP 110 206 HDI FAP 110 206 SW HDI FAP 110 207 CC HDI 207 HDI 3008 HDI 307 D 307 HDI 307 HDI 110 FAP 307 SW HDI 110 FAP 308 HDI 407 HDI 110 FAP 407 SW HDI 110 FAP 5008 HDI	110 PS / 80 KW 90 PS / 66 KW	DV6ATED4 (9HX) DV6TED4 (9HY) DV6TED4 (9HZ)	61707002 Motor Full Takım Gasket Full Set  61707003 Motor Üst Takım Gasket Head Set  61707004 Motor Alt Takım Conversion Set	61707005 0209.CG 1,45mm 5  61707006 0209.CF 1,40mm 4  61707007 0209.CC 1,30mm 3  61707008 0209.CA 1,25mm 2  61707009 0209.CE 1,35mm 1  MLS ø76
1,6 1580	4 CYL ø83 205 10/82--> 205 GTI 305 309	103 PS / 76 KW 72 PS / 53 KW	XU5CP (BAZ) XU5J (B6B) XU5J (180A) XU5J (180Z) XU5S (171) XU51C (B1A) XU51C (B1D) XU51C (B1E)	61207002 0197.89+0209.E1 61207003 0197.H6+0209.E1 62130002 0197.89+0209.L3 62130003 0197.H6+0209.L3	 61207005 0209.E1 1,30mm 1  61207006 0209.L8 1,50mm 2   62130005 0209.L3 1,50mm ø84,5

▲ : İçerikte Bulunmamaktadır...

▲ : Not included in the set

▲ : Non inclus dans la pochette

00: Motor Takım Keçesiz ve Subap Lastiksiz











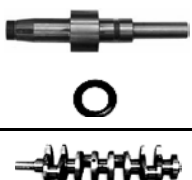
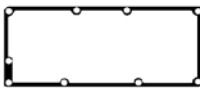







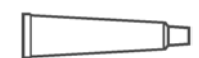

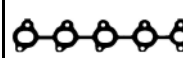

00: Gasket Set Without oil seals Without Valve Stem Seal

01: Motor Takım Keçesiz - Subap Lastikli

01: Gasket set With Valve Stem Seal Without Oil Seals

02: Motor Full Takım Keçeli ve Subap Lastikli

02: Gasket Full Set With oil seals and Valve Stem Seals

Subap Kapak Valve Cover Gasket Zylinderkopfhaube Couvre-culbut.	Karter Oil Pan Ölwanne Carter d'huile	Emme Manifold Intake Manifold Ansaug Admission	Egzoz Manifold Exhaust Manifold Auspuffkrümmer Collecteur D'echappement	Eksoz Boğaz Exhaust Pipe Auspuff Kehle	Supap Keçesi Valve Stem Seal Ventilschaft Queue de soupape	
						
 61707025 0249.C2	 62427465	 0348.R5 x4  0348.R4 x4 61707018 0348.R5+0348.R4 SET	 61706021 0349.J8 0349.J7 0349.N0 1 148 115		 61707026x16 0956.51 5,5x9,5x18,1x14	21204017 27x47x7 RD 21204018 40X55X6,4 LD 21204019 85X105X8,8 RD
 61207525 0249.48 91508054	 61203013 0304.34 93502226  61203014 93501565	 61203018x2 91508659.  61207018 951299280  61207019 0348.76	 61207020x4 0349.70 91505500  61205019 1721.01 7810024000	 61207017 1710.39 91511460	 60107027x8 0956.22 8x10,8/14,2x10	21201062 36x50x7 RD 21201019 42x62x8 RD 21201040 90x110x10 LD

 : Delik - Çentik

 : Hole - Notch

 : Trou - Entaille

NOT: Katalogdaki Orijinal Kodlar Referans Amacıyla Kullanılmıştır.Lütfen COTECH Kodlarını Kullanınız.
Original codes used for reference only.Please use COTECH codes for orders.

00



01



02



03



04



Silindir Kapak
Cylinder Head
Zylinderkopf
Joint de culasse

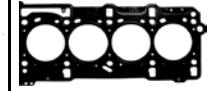

Ltr	MODEL	PS/KW	ENGINE/MOTOR		
1,6 1580	4 CYL ø83 205 07/87-->09/98 205 GTI 309 405	103 PS / 76 KW 72 PS / 53 KW	XU5CP (BAZ) XU5J (180A) XU5J (180Z) XU5M (BDY) XU5M (BDZ) XU5S (171) XU51C (B1A) XU51C (B1E) XU52C/K (B2A)	61207002 0197.89+0209.E1 61207003 0197.H6+0209.E1 62130002 0197.89+0209.L3 62130003 0197.H6+0209.L3	 61207005 0209.E1 1,30mm 1 61207006 0209.L8 1,50mm 2 62130005 0209.L3 1,50mm ø84,5
1,6 1580	4 CYL ø83 405 08/92-->05/04 406	88 PS / 65 KW	XU5JP(BFZ)	61233002 0197.G4+0209.E1	 61207005 0209.E1 1,30mm 1 61207006 0209.L8 1,50mm 2 62130005 0209.L3 1,50mm ø84,5
1,6 1581	4 CYL ø86,4 EXPERT 02/96-->	79 PS / 58 KW	222A2(1580SPI)	60304002 5890649 60304001	 60304005 0209.P9 1,80mm ø87

▲ : İçerikte Bulunmamaktadır...

▲ : Not included in the set

▲ : Non inclus dans la pochette

00: Motor Takım Keçesiz ve Subap Lastiksiz











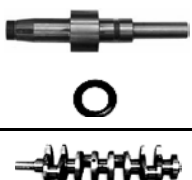
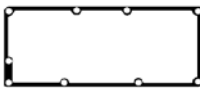















00: Gasket Set Without oil seals Without Valve Stem Seal

01: Motor Takım Keçesiz - Subap Lastikli

01: Gasket set With Valve Stem Seal Without Oil Seals

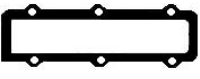
02: Motor Full Takım Keçeli ve Subap Lastikli

02: Gasket Full Set With oil seals and Valve Stem Seals

Subap Kapak Valve Cover Gasket Zylinderkopfhaube Couvre-culbut.	Karter Oil Pan Ölwanne Carter d'huile	Emme Manifold Intake Manifold Ansaug Admission	Egzoz Manifold Exhaust Manifold Auspuffkrümmer Collecteur D'échappement	Eksoz Boğaz Exhaust Pipe Auspuff Kehle	Supap Keçesi Valve Stem Seal Ventilschaft Queue de soupape	
						
 61207525 0249.48 91508054	 61203013 0304.34 93502226  61203014 93501565	 61203018x2 91508659.  61207018 951299280  61207019 0348.76	 61207020x4 0349.70 91505500  61205019 1721.01 7810024000	 61207017 1710.39 91511460	 60107027x8 0956.22 8x10,8/14,2x10	21201062 36x50x7 RD 21201019 42x62x8 RD 21201040 90x110x10 LD
 61233025 0249.71	 61203013 0304.34 93502226.	 61233018x4 0348.E6 + 0348F6	 61233020x4 1723.63		 60107027x8 0956.22 8x10,8/14,2x10	21201062 36x50x7 RD 21201019 42x62x8 RD 21201040 90x110x10 LD
 60304034 0249.83  60304035 0249.84	 60304013 0304.49	 60304020 7772495			 60107027x8 0956.22 8x10,8/14,2x10	21201006x2 30x52x7 RD 21201017 40x56x7 RD 21201030 64x80x8 LD

■ : Delik - Çentik

■ : Hole - Notch

■ : Trou - Entaille

NOT: Katalogdaki Orijinal Kodlar Referans Amacıyla Kullanılmıştır.Lütfen COTECH Kodlarını Kullanınız.
Original codes used for reference only.Please use COTECH codes for orders.

00



Silindir Kapak
Cylinder Head

01



Zylinderkopf

02



Joint de culasse

03



04

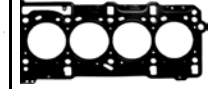

Ltr	MODEL	PS/KW	ENGINE/MOTOR		
1,6 1587	4 CYL ø78,5 PARTNER 08/00--> PARTNER 16V 1007 16V 206 206 CC 16V 206 SW 16V 206 16V 207 307 307 CC 16V 307 SW 16V 307 16V 308	112 PS / 82 KW 106 PS / 78 KW	TU5JP4 (NFU) TU5JP4 (N6A)	62200002 0135.EH 62200003 Motor Üst Takım Gasket Head Set 62200004 Motor Alt Takım Conversion Set	 62200005 0209.1E MLS ø79,5
1,6 1618	4 CYL ø84 504 01/80-->06/87 J7 08/68-->03/80 J9 03/80-->06/87	60 PS / 44 KW 63 PS / 46 KW	XC7P	61210001 0197.L1	 61210005 0209.F8 ø86,7
1,8 1761	4 CYL ø83 306 05/93-->04/02 405 08/92-->10/96 406 05/97-->10/04 PARTNER 05/97--> EXPERT	101 PS / 74 KW 88 PS / 65 KW	XU7JP(LFZ) XU7JB(LFX)	61233002 0197.G4+0209.E1	 61207005 0209.E1 1,30mm 1 61207006 0209.L8 1,50mm 2 62130005 0209.L3 1,50mm ø84,5

▲ : İçerikte Bulunmamaktadır...

▲ : Not included in the set

▲ : Non inclus dans la pochette

00: Motor Takım Keçesiz ve Subap Lastiksiz











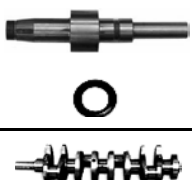
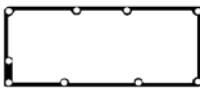



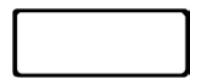

00: Gasket Set Without oil seals Without Valve Stem Seal

01: Motor Takım Keçesiz - Subap Lastikli

01: Gasket set With Valve Stem Seal Without Oil Seals

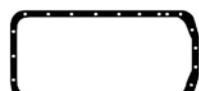
02: Motor Full Takım Keçeli ve Subap Lastikli

02: Gasket Full Set With oil seals and Valve Stem Seals

Subap Kapak Valve Cover Gasket Zylinderkopfhaube Couvre-culbut.	Karter Oil Pan Ölwanne Carter d'huile	Emme Manifold Intake Manifold Ansaug Admission	Egzoz Manifold Exhaust Manifold Auspuffkrümmer Collecteur D'echappement	Eksoz Boğaz Exhaust Pipe Auspuff Kehle	Supap Keçesi Valve Stem Seal Ventilschaft Queue de soupape	
						
62200025 0249.A9	62200065 0304.55	62200018x4 0348.Q5	62200021 0349.J4	62200017 1709.25	62427426x16 0956.40 6x8,8x11,7x9,5	21201741x2 38x50x6 RD
						21201021 42x66x6 RD
						21204504 85x105x8 LD
						
61210525 0249.14	61210013 0304.44	61211016 0348.33	61210020 0349.03		60107027x8 0956.22 8x10,8/14,2x10	
						21201062 36x50x7 RD
61233025 0249.71	61203013 0304.34 93502226.	61233018x4 0348.E6 + 0348F6	61233020x4 1723.63		60107027x8 0956.22 8x10,8/14,2x10	21201019 42x62x8 RD
						21201040 90x110x10 LD

 : Delik - Çentik

 : Hole - Notch

 : Trou - Entaille

NOT: Katalogdaki Orijinal Kodlar Referans Amacıyla Kullanılmıştır.Lütfen COTECH Kodlarını Kullanınız.
Original codes used for reference only.Please use COTECH codes for orders.

00



01



02



03



04



Silindir Kapak
Cylinder Head
Zylinderkopf
Joint de culasse

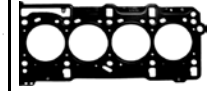

Ltr	MODEL	PS/KW	ENGINE/MOTOR		
1,8 1761	4 CYL ø83 306 16V 03/97-->04/02 406 16V 11/95-->10/00	110 PS / 81 KW	XU7JP4(LFY)		<p>62220005 0209.Q3 1,20mm 1 M</p> <p>62220006 0209.V4 1,40mm 2 M</p> <p>62220007 1,60mm 3 M ø84</p>
1,8 1769	4 CYL ø80 PARTNER D 11/82--> 205 D 305 D 306 306 D 309 D	60 PS / 44 KW 58 PS / 43 KW	XUD7 (A9A) XUD7 (161A) 161 (XUD7) 161A (XUD7)	<p>61204002 0197.H5</p> <p>61204003 0197.H4</p>	<p>61203009 0209.S0 1,36 mm. 1 M</p> <p>61203008 0209.S1 1,40 mm. 2 M</p> <p>61203007 0209.S2 1,44 mm. 3 M</p> <p>61203006 0209.S3 1,48 mm. 4 M</p> <p>61203005 0209. S4 1,53 mm. 5 M ø82</p>
1,8 1769	4 CYL ø80 205 10/87-->09/98 205 TD 309 TD 405 D 405 DT 405 TD	90 PS / 66 KW 78 PS / 57 KW	XUD7T XUD7TE (AJZ) XUD7TE (A8A) XUD7TE (A8B)	<p>61204002 0197.H5</p> <p>61204003 0197.H4</p>	

▲ : İçerikte Bulunmamaktadır...

▲ : Not included in the set

▲ : Non inclus dans la pochette

00: Motor Takım Keçesiz ve Subap Lastiksiz











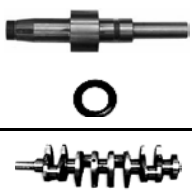
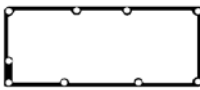





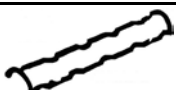



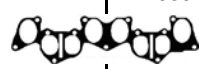

00: Gasket Set Without oil seals Without Valve Stem Seal

01: Motor Takım Keçesiz - Subap Lastikli

01: Gasket set With Valve Stem Seal Without Oil Seals

02: Motor Full Takım Keçeli ve Subap Lastikli

02: Gasket Full Set With oil seals and Valve Stem Seals

Subap Kapak Valve Cover Gasket Zylinderkopfhaube Couvre-culbut.	Karter Oil Pan Ölwanne Carter d'huile	Emme Manifold Intake Manifold Ansaug Admission	Egzoz Manifold Exhaust Manifold Auspuffkrümmer Collecteur D'echappement	Eksoz Boğaz Exhaust Pipe Auspuff Kehle	Supap Keçesi Valve Stem Seal Ventilschaft Queue de soupape	
						
 61203525 0249.46 0249.91	 61203013 0304.34  61203014 93501565	 61203116x2 0348.99  61203018x2 91508659  61203021 0348.JO	 61205019 1721.01 7810024000  61203120x2 0349.47 93010402		 60107027x8 0956.22 8x10,8/14,2x10	21201011x2 35x50x8 WD 21201019 42x62x8 RD 21201040 90x110x7 LD
 61203525 0249.46 0249.91	 61203013 0304.34  61203014 93501565	 61203116x2 0348.99  61203018x2 91508659  61203021 0348.JO	 61205019 1721.01 7810024000  61203120x2 0349.47 93010402		 60107027x8 0956.22 8x10,8/14,2x10	21201011x2 35x50x8 WD 21201019 42x62x8 RD 21201040 90x110x7 LD

■ : Delik - Çentik

■ : Hole - Notch

■ : Trou - Entaille

NOT: Katalogdaki Orijinal Kodlar Referans Amacıyla Kullanılmıştır.Lütfen COTECH Kodlarını Kullanınız.
Original codes used for reference only.Please use COTECH codes for orders.

00



01



02



03



04



Silindir Kapak
Cylinder Head
Zylinderkopf
Joint de culasse

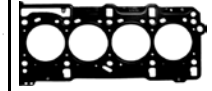

Ltr	MODEL	PS/KW	ENGINE/MOTOR		
1,8 1796	4 CYL ø84 504 07/68-->12/89 505 06/81-->10/86 J5 01/83-->11/88 J7 07/70-->03/80	65 PS / 48 KW 69 PS / 51 KW 73 PS / 54 KW 82 PS / 60 KW 84 PS / 62 KW	105 (XM7) 169B(XM7T) XM XM7 XM7P	61210001 0197.L1 0197.15	 61210005 0209.F8 ø86,7
1,9 1868	4 CYL ø82,2 EXPERT D 06/96--> PARTNER D 206 D 306 D	69 PS / 51 KW	DW8 (WJZ) DW8B (WJY)	62173002 0197.X6	 62173005 0209.1C 1,47mm 62173006 0209.X4 1,42mm 5 62173007 0209.X3 1,38mm 4 62173008 0209.X2 1,34mm 3 62173009 0209.X1 1,30mm 2 62173010 0209.X0 1,26mm 1 MLS ø84
1,9 1905	4 CYL ø83 205 09/84-->07/89 205 GTI 305 309 309 GTI	128 PS / 94 KW 98 PS / 72 KW	XU9JA (D6B) XU9J1 (DFZ) XU9S (D2B) XU9S (159)	61207002 0197.89+0209.E1 61207003 0197.H6+0209.E1 62130002 0197.89+0209.L3 62130003 0197.H6+0209.L3	 61207005 0209.E1 1,30mm 1 61207006 0209.L8 1,50mm 2 62130005 0209.L3 1,50mm ø84,5

▲ : İçerikte Bulunmamaktadır...

▲ : Not included in the set

▲ : Non inclus dans la pochette

00: Motor Takım Keçesiz ve Subap Lastiksiz











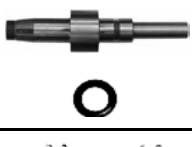
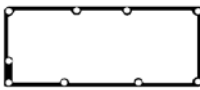





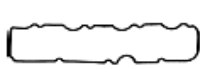



00: Gasket Set Without oil seals Without Valve Stem Seal

01: Motor Takım Keçesiz - Subap Lastikli

01: Gasket set With Valve Stem Seal Without Oil Seals

02: Motor Full Takım Keçeli ve Subap Lastikli

02: Gasket Full Set With oil seals and Valve Stem Seals

Subap Kapak Valve Cover Gasket Zylinderkopfhaube Couvre-culbut.	Karter Oil Pan Ölwanne Carter d'huile	Emme Manifold Intake Manifold Ansaug Admission	Egzoz Manifold Exhaust Manifold Auspuffkrümmer Collecteur D'echappement	Eksoz Boğaz Exhaust Pipe Auspuff Kehle	Supap Keçesi Valve Stem Seal Ventilschaft Queue de soupape	
						
61210525 0249.14	61210013 0304.44	61211016 0348.33	61210020 0349.03		60107027x8 0956.22 8x10,8/14,2x10	
						21208023 35x50x8 RD
62173025 0249.95	61203013 0304.34	62173018x2 0348.N2	62173021x2 0349.H7		60107027x8 0956.22 8x10,8/14,2x10	21201019 42x62x8 RD
						21201040 90x110x10 LD
						21201062 36x50x7 RD
61207525 0249.48 91508054	61203013 0304.34 93502226 61203014 93501565	61203018x2 91508659.  61207018 951299280  61207019 0348.76	61207020x4 0349.70 91505500  61205019 1721.01 7810024000	61207017 1710.39 91511460	60107027x8 0956.22 8x10,8/14,2x10	21201019 42x62x8 RD
						21201040 90x110x10 LD

■ : Delik - Çentik

■ : Hole - Notch

■ : Trou - Entaille

NOT: Katalogdaki Orijinal Kodlar Referans Amacıyla Kullanılmıştır.Lütfen COTECH Kodlarını Kullanınız.
Original codes used for reference only.Please use COTECH codes for orders.

00



01



02



03



04



Silindir Kapak
Cylinder Head
Zylinderkopf
Joint de culasse

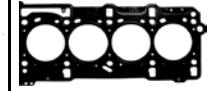

Ltr	MODEL	PS/KW	ENGINE/MOTOR		
1,9 1905	4 CYL ø83 205 06/87-->05/97 205 CTI 205 GTI 309 309 GTI 405 405 01/89-->12/92	121 PS / 89 KW 95 PS / 70 KW 122 PS / 90 KW	XU9JAZ (DKZ) XU9J1 (DFZ) XU9M (DDZ) XU92C (D2A) XU92C (D2C) XU9J2 (D6A)	61207002 0197.89+0209.E1 61207003 0197.H6+0209.E1 62130002 0197.89+0209.L3 62130003 0197.H6+0209.L3	 61207005 0209.E1 1,30mm 1 61207006 0209.L8 1,50mm 2 62130005 0209.L3 1,50mm ø84,5
1,9 1905	4 CYL ø83 309 GTI 16V 405	158 PS / 116 KW 147 PS / 108 KW	XU9J4 (D6C) XU9J4Z (DFW)		 62130005 0209.L3 1,50mm ø84,5
1,9 1905	4 CYL ø83 J5 10/82-->05/01 J5 D PARTNER D 205 D 305 D 306 D 306 SLD 306 STD 309 D 405 D 305 D 10/82-->12/93 309 D 10/82-->12/93	69 PS / 51 KW 64 PS / 47 KW 64 PS / 47 KW 64 PS / 47 KW	XUD9 XUD9 (DJZ) XUD9 (162) XUD9 (D9A) XUD9 (D9A)	61204002 0197.H5 61204003 0197.H4 	 61204009 0209.S5 1,36 mm 1 61204008 0209.S6 1,40 mm 2 61204007 0209.S7 1,44 mm 3 61204006 0209.S8 1,48 mm 4 61204005 0209.S9 1,53 mm 5 ø 84

▲ : İçerikte Bulunmamaktadır...

▲ : Not included in the set

▲ : Non inclus dans la pochette

00: Motor Takım Keçesiz ve Subap Lastiksiz











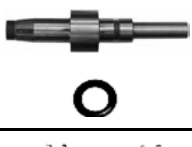
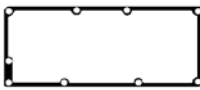













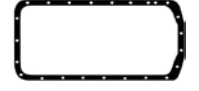

00: Gasket Set Without oil seals Without Valve Stem Seal

01: Motor Takım Keçesiz - Subap Lastikli

01: Gasket set With Valve Stem Seal Without Oil Seals

02: Motor Full Takım Keçeli ve Subap Lastikli

02: Gasket Full Set With oil seals and Valve Stem Seals

Subap Kapak Valve Cover Gasket Zylinderkopfhaube Couvre-culbut.	Karter Oil Pan Ölwanne Carter d'huile	Emme Manifold Intake Manifold Ansaug Admission	Egzoz Manifold Exhaust Manifold Auspuffkrümmer Collecteur D'echappement	Eksoz Boğaz Exhaust Pipe Auspuff Kehle	Supap Keçesi Valve Stem Seal Ventilschaft Queue de soupape	
						
 61207525 0249.48 91508054	 61203013 0304.34 93502226  61203014 93501565	 61203018x2 91508659.  61207018 951299280  61207019 0348.76	 61207020x4 0349.70 91505500  61205019 1721.01 7810024000	 61207017 1710.39 91511460	 60107027x8 0956.22 8x10,8/14,2x10	21201062 36x50x7 RD 21201019 42x62x8 RD 21201040 90x110x10 LD
 61203525 0249.46 0249.91	 61203013 0304.34  61203014 93501565	 61203116x2 0348.99  61203018x2 91508659  61203021 0348.JO	 61205019 1721.01 7810024000  61203120x2 0349.47 93010402		 60107027x8 0956.22 8x10,8/14,2x10	21201011x2 35x50x8 WD 21201019 42x62x8 RD 21201040 90x110x7 LD

■ : Delik - Çentik

■ : Hole - Notch

■ : Trou - Entaille

NOT: Katalogdaki Orijinal Kodlar Referans Amacıyla Kullanılmıştır.Lütfen COTECH Kodlarını Kullanınız.
Original codes used for reference only.Please use COTECH codes for orders.

00



01



02



03









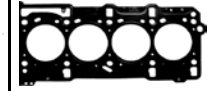



04



Silindir Kapak
Cylinder Head
Zylinderkopf
Joint de culasse



Ltr	MODEL	PS/KW	ENGINE/MOTOR		
1,9 1905	4 CYL ø83 BOXER Bus D 03/88--> BOXER D EXPERT D J5 Bus D J5 D PARTNER D 306 D 306 SLD 405 D	70 PS / 51 KW 68 PS / 50 KW	XUD9A (DJY) XUD9A (D9B) XUD9AU (D8C)	61204002 0197.H5  61204003 0197.H4 	 61204009 0209.S5 1,36 mm 1  61204008 0209.S6 1,40 mm 2  61204007 0209.S7 1,44 mm 3  61204006 0209.S8 1,48 mm 4  61204005 0209.S9 1,53 mm 5  ø 84
1,9 1905	4 CYL ø83 BOXER 08/92--> BOXER Bus TD BOXER TD EXPERT DT EXPERT TD 306 D 306 DT 306 SRDT 306 TD 405 TD 406 D 406 TD 806 TD	94 PS / 69 KW 75 PS / 55 KW	XUD9BSD (DHV) XUD9SD (DHW) XUD9TE XUD9TE (DHX) XUD9TE (DHY) XUD9TE (D8B) XUD9UTF (D8C)	61204002 0197.H5  61204003 0197.H4 	
1,9 1948	4 CYL ø88 504 03/73-->12/89 J7 08/68-->07/78	55 PS / 40 KW	XDP88 XD4X88	61212002 0198.40	 61212005 0203.70 1,60mm 61212006 0209.L2 1,80mm ø94

▲ : İçerikte Bulunmamaktadır...

▲ : Not included in the set

▲ : Non inclus dans la pochette

00: Motor Takım Keçesiz ve Subap Lastiksiz











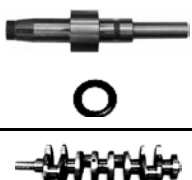
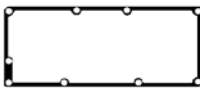





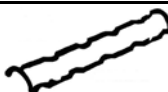













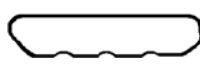

00: Gasket Set Without oil seals Without Valve Stem Seal

01: Motor Takım Keçesiz - Subap Lastikli

01: Gasket set With Valve Stem Seal Without Oil Seals

02: Motor Full Takım Keçeli ve Subap Lastikli

02: Gasket Full Set With oil seals and Valve Stem Seals

Subap Kapak Valve Cover Gasket Zylinderkopfhaube Couvre-culbut.	Karter Oil Pan Ölwanne Carter d'huile	Emme Manifold Intake Manifold Ansaug Admission	Egzoz Manifold Exhaust Manifold Auspuffkrümmer Collecteur D'echappement	Eksoz Boğaz Exhaust Pipe Auspuff Kehle	Supap Keçesi Valve Stem Seal Ventilschaft Queue de soupape	
						
 61203525 0249.46 0249.91	 61203013 0304.34  61203014 93501565	 61203116x2 0348.99  61203018x2 91508659  61203021 0348.JO	 61205019 1721.01 7810024000  61203120x2 0349.47 93010402		 60107027x8 0956.22 8x10,8/14,2x10	21201011x2 35x50x8 WD 21201019 42x62x8 RD 21201040 90x110x7 LD
 61203525 0249.46 0249.91	 61203013 0304.34  61203014 93501565	 61203116x2 0348.99  61203018x2 91508659  61203021 0348.JO	 61205019 1721.01 7810024000  61203120x2 0349.47 93010402		 60107027x8 0956.22 8x10,8/14,2x10	21201011x2 35x50x8 WD 21201019 42x62x8 RD 21201040 90x110x7 LD
 61212525 0249.25	 61212014 0313.19  61212015 0304.12	 61212016x3 0348.11	 61212020x2 0349.08	 61205018 1710.07  61212018 1710.15  61212019 1710.19	21201020 42x60x10 RD	

■ : Delik - Çentik

■ : Hole - Notch

■ : Trou - Entaille

NOT: Katalogdaki Orijinal Kodlar Referans Amacıyla Kullanılmıştır.Lütfen COTECH Kodlarını Kullanınız.
Original codes used for reference only.Please use COTECH codes for orders.

00



Silindir Kapak

Cylinder Head

01



Zylinderkopf

02



Joint de culasse

03



04

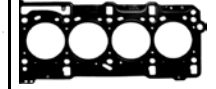

Ltr	MODEL	PS/KW	ENGINE/MOTOR		
2.0 1971	4 CYL ø88				
504	03/71-->07/86	97 PS / 71 KW	XN1	61211001 9400197139	 61211005 0209.46 1,20mm 61211006 0209.46 1,80mm ø90
505		92 PS / 68 KW	XN1 (106)		
504	09/79--->08/82	94 PS / 69 KW	XN1		
505	09/85-->09/91	98 PS / 72 KW	XN1A(106E)		
J5	03/80-->08/90	79 PS / 58 KW	XN1P		
J9		78 PS / 57 KW			
J9 Bus					
J5	09/87-->08/90	75 PS / 55 KW	XN1T		
J5 Bus	09/81-->	85 PS / 62 KW	XN1T (170)		
		75 PS / 55 KW	XN1T (170B)		
			XN1TA (170C)		
J5	09/90-->01/94	94 PS / 69 KW	XN1TA		
		84 PS / 62 KW			
504	01/71-->08/84	106 PS / 78 KW	XN2(107)		
2.0 1998	4 CYL ø86				
306 16V	03/97-->04/02	132 PS / 97 KW	XU10J4R (RFV)		 62170005 0209.N6 1.35 mm 1 62170006 0209.T9 1,50mm 2 ø87
406 16V	11/95-->10/04				
605 16V	07/94-->09/99				
806 16V	05/98-->09/00				

▲ : İçerikte Bulunmamaktadır...

▲ : Not included in the set

▲ : Non inclus dans la pochette

00: Motor Takım Keçesiz ve Subap Lastiksiz











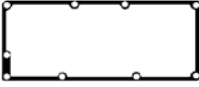

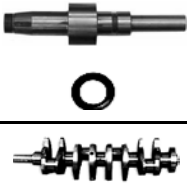
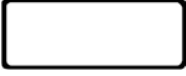

00: Gasket Set Without oil seals Without Valve Stem Seal

01: Motor Takım Keçesiz - Subap Lastikli

01: Gasket set With Valve Stem Seal Without Oil Seals

02: Motor Full Takım Keçeli ve Subap Lastikli

02: Gasket Full Set With oil seals and Valve Stem Seals

<p>Subap Kapak Valve Cover Gasket Zylinderkopfhaube Couvre-culbut.</p> 	<p>Karter Oil Pan Ölwanne Carter d'huile</p> 	<p>Emme Manifold Intake Manifold Ansaug Admission</p> 	<p>Egzoz Manifold Exhaust Manifold Auspuffkrümmer Collecteur D'echappement</p> 	<p>Eksoz Boğaz Exhaust Pipe Auspuff Kehle</p> 	<p>Supap Keçesi Valve Stem Seal Ventilschaft Queue de soupape</p> 	
 <p>61210525 0249.14</p>	 <p>61210013 0322.10 0304.11</p>	 <p>61211016 0348.33</p>  <p>61211015 0348.21</p>	 <p>61210020 0349.03</p>	 <p>61205017 1710.09</p>  <p>61212019 1710.19</p>	 <p>60107027x8 0956.22 8x10,8/14,2x10</p>	

■ : Delik - Çentik

■ : Hole - Notch

■ : Trou - Entaille

NOT: Katalogdaki Orijinal Kodlar Referans Amacıyla Kullanılmıştır.Lütfen COTECH Kodlarını Kullanınız.
Original codes used for reference only.Please use COTECH codes for orders.

00



01



02



03



04



Silindir Kapak
Cylinder Head
Zylinderkopf
Joint de culasse

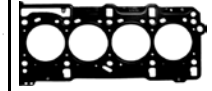

Ltr	MODEL	PS/KW	ENGINE/MOTOR		
2,1 2112	4 CYL ø90 J9 D 03/80-->06/87 J7 Bus D 08/98-->07/86 J7 D 504 D	56 PS / 41 KW 65 PS / 48 KW 57 PS / 42 KW	XDPX90 XDP90 XD4x90	61212002 0198.40	 61212005 0203.70 1,60mm 61212006 0209.L2 1,80mm ø94
2,3 2304	4 CYL ø94 504 07/75-->12/89 J7 Bus D 07/77-->07/82 J7 D J9 Bus D J9 D 505 D 09/79-->06/86 505 TD 604 TD	69 PS / 51 KW 67 PS / 49 KW 80 PS / 59 KW	XD2(134) XD2PX94 XD2P94 XD2S (147)	61218000 0198.94 	 61218005 0209.C6 1,73mm 4 61218006 0209.C4 1,63mm 3 61218007 0209.C2 1,53mm 2 ø96
2,5 2498	4 CYL ø94 505 D 06/81-->12/93 J9 Bus D 07/82-->06/87 J9 D 505 TD 08/83--> 604 TD	75 PS / 55 KW 69 PS / 51 KW 72 PS / 53 KW 105 PS / 74 KW 73 PS / 54 KW	XD3 (155) XD3P XD3T (152A) XD3TE XD3TE (152B)	61218000 0198.94 	 61218005 0209.C6 1,73mm 4 61218006 0209.C4 1,63mm 3 61218007 0209.C2 1,53mm 2 ø96

▲ : İçerikte Bulunmamaktadır...

▲ : Not included in the set

▲ : Non inclus dans la pochette

00: Motor Takım Keçesiz ve Subap Lastiksiz











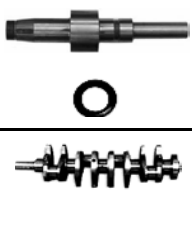
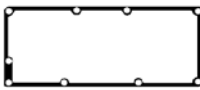







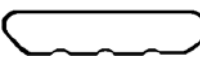







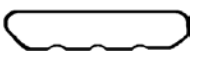



00: Gasket Set Without oil seals Without Valve Stem Seal

01: Motor Takım Keçesiz - Subap Lastikli

01: Gasket set With Valve Stem Seal Without Oil Seals

02: Motor Full Takım Keçeli ve Subap Lastikli

02: Gasket Full Set With oil seals and Valve Stem Seals

Subap Kapak Valve Cover Gasket Zylinderkopfhaube Couvre-culbut.	Karter Oil Pan Ölwanne Carter d'huile	Emme Manifold Intake Manifold Ansaug Admission	Egzoz Manifold Exhaust Manifold Auspuffkrümmer Collecteur D'echappement	Eksoz Boğaz Exhaust Pipe Auspuff Kehle	Supap Keçesi Valve Stem Seal Ventilschaft Queue de soupape	
						 
 61212525 0249.25	 61212014 0313.19  61212015 0304.12	 61212016x3 0348.11	 61212020x2 0349.08	 61205018 1710.07  61212018 1710.15  61212019 1710.19		21201020 42x60x10 RD
 61212525 0249.25	 61212014 0313.19  61212015 0304.12	 61212016x3 0348.11	 61212020x2 0349.10	 61212018 1710.15  61212019 1710.19		
 61212525 0249.25	 61212014 0313.19  61212015 0304.12	 61212016x3 0348.11	 61212020x2 0349.10	 61212018 1710.15  61212019 1710.19		

 : Delik - Çentik

 : Hole - Notch

 : Trou - Entaille

NOT: Katalogdaki Orijinal Kodlar Referans Amacıyla Kullanılmıştır.Lütfen COTECH Kodlarını Kullanınız.
Original codes used for reference only.Please use COTECH codes for orders.

00



Silindir Kapak
Cylinder Head
Zylinderkopf
Joint de culasse

01



02



03



04

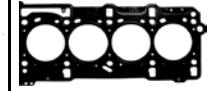

Ltr	MODEL	PS/KW	ENGINE/MOTOR		
2,5 2500	4 CYL ø93 J5 J5 Bus D J5 D J5 DT 09/81--> 09/81-->01/94	73 PS / 54 KW 95 PS / 70 KW	CRD93 CRD93L	61215003 0197.K1	 61215005 0209.L5 1,40mm ø95,5
2,5 2500	4 CYL ø93 J5 Bus TD J5 TD 10/90-->	95 PS / 70 KW	CRD93LS	61215103 0197.R9	 61215105 0209.L6 1,40mm ø95,5
2,7 2664	6 CYL ø88 604 504 604 08/77-->05/83 08/77-->08/84	136 PS / 100 KW 144 PS / 106 KW	ZM(112) ZMJ(140)		 0203.67 1,20mm 0203.66 1,20mm ø90 60115005
2,8 2799	4 CYL ø94,4 BOXER BOXER DTIC BOXER TD BOXER HDI BOXER BUS HDI 10/97-->03/05 10-00-->	122 PS / 90 KW 128 PS / 94 KW 126 PS / 93 KW	8140.43(F28DT) 8140.43S (F28DTCR)	60139100 71713696 	 60139005 0209.OF 1,50mm 60139006 0209.OE 1,40mm 60139007 0209.OC 1,30mm ø96

▲ : İçerikte Bulunmamaktadır...

▲ : Not included in the set

▲ : Non inclus dans la pochette

00: Motor Takım Keçesiz ve Subap Lastiksiz











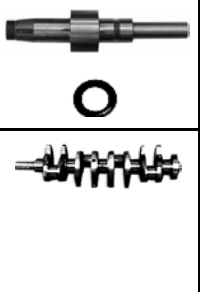
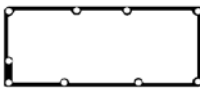







00: Gasket Set Without oil seals Without Valve Stem Seal

01: Motor Takım Keçesiz - Subap Lastikli

01: Gasket set With Valve Stem Seal Without Oil Seals

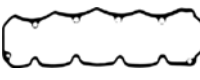
02: Motor Full Takım Keçeli ve Subap Lastikli

02: Gasket Full Set With oil seals and Valve Stem Seals

Subap Kapak Valve Cover Gasket Zylinderkopfhaube Couvre-culbut.	Karter Oil Pan Ölwanne Carter d'huile	Emme Manifold Intake Manifold Ansaug Admission	Egzoz Manifold Exhaust Manifold Auspuffkrümmer Collecteur D'echappement	Eksoz Boğaz Exhaust Pipe Auspuff Kehle	Supap Keçesi Valve Stem Seal Ventilschaft Queue de soupape	
						
 61215025 5 450 155		 61215019x4 0348.H0	 61215021x4 0349.F0	 61215017 95494600		
 61215025 5 450 155		 61215019x4 0348.H0	 61215021x4 0349.F0	 61215017 95494600		
 60138045 0249.A0	 60138068 500327440	 60146019x4 98425767	 60147021x4 98434020			
 60138047 0249.C3						

 : Delik - Çentik

 : Hole - Notch

 : Trou - Entaille

NOT: Katalogdaki Orijinal Kodlar Referans Amacıyla Kullanılmıştır.Lütfen COTECH Kodlarını Kullanınız.
Original codes used for reference only.Please use COTECH codes for orders.

PROTON

00



Silindir Kapak
Cylinder Head
Zylinderkopf
Joint de culasse

01



02



03



04

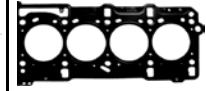

Ltr	MODEL	PS/KW	ENGINE/MOTOR		
1,1 1124	4 CYL ø72 TIARA 1996-->	60 PS / 44 KW	TU1	61209002 Motor Full Takım Gasket Full Set 61209003 0197.H8+0209.CJ 61209004 0197.H9	61209005 0209.CJ 1,30mm 1 61209006 0209.W6 - W7 1,50 mm 2 ø76
1,3 1298	4 CYL ø71 SAGA 1985-->	77 PS / 56 KW	4G13		61507005 MD066163 1,40mm ø72,5
1,3 1298	4 CYL ø71 PERSONA 12V 01/94--> WIRA 12V ISWARA 12V SATRIA 12V	75 PS / 55 KW	4G13		61415405 MD323473 1,40mm ø76,5
1,5 1468	4 CYL ø75,5 SAGA 1985-->	75 PS / 55 KW	4G15		61500305 MD016163 1,40mm 61500306 MD016163 2,00mm ø76,5
1,5 1468	4 CYL ø75,5 PERSONA 12V 05/89-->08/99 WIRA 12V ISWARA 12V SATRIA 12V	90 PS / 66 KW 75 PS / 55 KW	4G15		61415405 MD323473 1,40mm ø76,5

▲ : İçerikte Bulunmamaktadır...

▲ : Not included in the set

▲ : Non inclus dans la pochette

00: Motor Takım Keçesiz ve Subap Lastiksiz











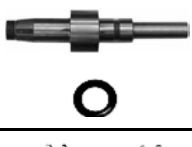
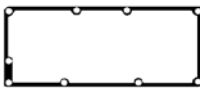

00: Gasket Set Without oil seals Without Valve Stem Seal

01: Motor Takım Keçesiz - Subap Lastikli

01: Gasket set With Valve Stem Seal Without Oil Seals

02: Motor Full Takım Keçeli ve Subap Lastikli

02: Gasket Full Set With oil seals and Valve Stem Seals

Subap Kapak Valve Cover Gasket Zylinderkopfhaube Couvre-culbut.	Karter Oil Pan Ölwanne Carter d'huile	Emme Manifold Intake Manifold Ansaug Admission	Egzoz Manifold Exhaust Manifold Auspuffkrümmer Collecteur D'echappement	Eksoz Boğaz Exhaust Pipe Auspuff Kehle	Supap Keçesi Valve Stem Seal Ventilschaft Queue de soupape	
						
						21201062 36x50x7 RD
61209025 0249.54	61209013 0304.304	61209019x2	61209020x2 0349,A6	61209017 1709.15	60116026x8 0956.19 7x9,8/13.2x10	21201021 42x66x6 RD
						21204504 85x105x8 LD

 : Delik - Çentik

 : Hole - Notch

 : Trou - Entaille

NOT: Katalogdaki Orijinal Kodlar Referans Amacıyla Kullanılmıştır.Lütfen COTECH Kodlarını Kullanınız.
Original codes used for reference only.Please use COTECH codes for orders.

00



Silindir Kapak
Cylinder Head

01



Zylinderkopf

02



Joint de culasse

03



04



Ltr MODEL PS/KW ENGINE/MOTOR

1,6 4 CYL ø76,5

WAJA

1995-->2006

GEN-2

PERSONA



61415605

PW811553

1,20mm

FIBER / FIBRE

ø77,5

▲ : İçerikte Bulunmamaktadır...

▲ : Not included in the set

▲ : Non inclus dans la pochette

00: Motor Takım Keçesiz ve Subap Lastiksiz







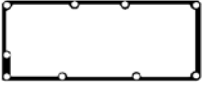
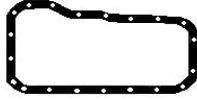

00: Gasket Set Without oil seals Without Valve Stem Seal

01: Motor Takım Keçesiz - Subap Lastikli

01: Gasket set With Valve Stem Seal Without Oil Seals

02: Motor Full Takım Keçeli ve Subap Lastikli

02: Gasket Full Set With oil seals and Valve Stem Seals

<p>Subap Kapak Valve Cover Gasket Zylinderkopfhaube Couvre-culbut.</p> 	<p>Karter Oil Pan Ölwanne Carter d'huile</p> 	<p>Emme Manifold Intake Manifold Ansaug Admission</p> 	<p>Egzoz Manifold Exhaust Manifold Auspuffkrümmer Collecteur D'echappement</p> 	<p>Eksoz Boğaz Exhaust Pipe Auspuff Kehle</p> 	<p>Supap Keçesi Valve Stem Seal Ventilschaft Queue de soupape</p> 	  

■ : Delik - Çentik

■ : Hole - Notch

■ : Trou - Entaille

NOT: Katalogdaki Orijinal Kodlar Referans Amacıyla Kullanılmıştır.Lütfen COTECH Kodlarını Kullanınız.
Original codes used for reference only.Please use COTECH codes for orders.

00



01



02



03



04



Silindir Kapak
Cylinder Head
Zylinderkopf
Joint de culasse

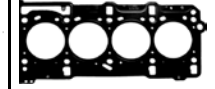

Ltr	MODEL	PS/KW	ENGINE/MOTOR		
0,75 747	4 CYL ø54,5 R 4 04/62-->	27 PS / 20 KW 20 PS / 15 KW	680 701 680 702	60106001 7701460365	<p>60106005 7700724333 1,20mm</p> <p>60106006 7700724333 1,80mm ø59,7</p>
0,85 845	4 CYL ø58 RODEO 4 10/62--> RODEO 6 4 5	37 PS / 27 KW 26 PS / 19 KW	B1B 707 800 800 01 800 02 800 05 800 705 800 710 839 839 06 839 07 839 701 839 706 839 707	60106001 7701460365	<p>60106005 7700724333 1,20mm</p> <p>60106006 7700724333 1,80mm ø59,7</p>
0,85 852	4 CYL ø61,4 R 4 01/76-->12/76 F 4	29 PS / 21 KW	813,02	60108002 77 01 459 391	<p>60108005 77 00 680 688 1,20mm</p> <p>60108006 77 00 680 688 1,80mm ø72</p>
1.0 956	4 CYL ø65 R 5 01/72-->12/85	44 PS / 32 KW	689 710	60108002 77 01 459 391	<p>60108005 77 00 680 688 1,20mm</p> <p>60108006 77 00 680 688 1,80mm ø72</p>

▲ : İçerikte Bulunmamaktadır...

▲ : Not included in the set

▲ : Non inclus dans la pochette

00: Motor Takım Keçesiz ve Subap Lastiksiz











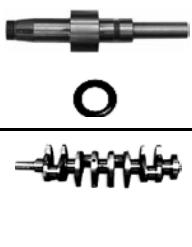
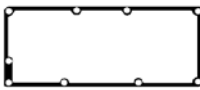

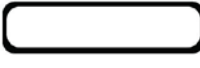

00: Gasket Set Without oil seals Without Valve Stem Seal

01: Motor Takım Keçesiz - Subap Lastikli

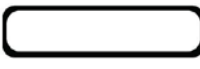
01: Gasket set With Valve Stem Seal Without Oil Seals

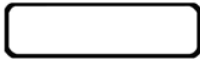
02: Motor Full Takım Keçeli ve Subap Lastikli

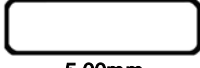
02: Gasket Full Set With oil seals and Valve Stem Seals

Subap Kapak Valve Cover Gasket Zylinderkopfhaube Couvre-culbut.	Karter Oil Pan Ölwanne Carter d'huile	Emme Manifold Intake Manifold Ansaug Admission	Egzoz Manifold Exhaust Manifold Auspuffkrümmer Collecteur D'echappement	Eksoz Boğaz Exhaust Pipe Auspuff Kehle	Supap Keçesi Valve Stem Seal Ventilschaft Queue de soupape	
						
 60106034 05 55 565 700	 60106265 980656900	 60106020 (x2) 77 00 522 372				
 60106034 05 55 565 700	 60106265 980656900	 60106020 (x2) 77 00 522 372				
 5,00mm 60101525 77 00 723 967	 60101265 77 01 453 950	 60101020 77 00 559 702			▲	21208003 30x42x7 RD
						21201034 80x100x13 LD
 5,00mm 60101525 77 00 723 967	 60101265 77 01 453 950	 60101020 77 00 559 702			▲	21208003 30x42x7 RD
						21201034 80x100x13 LD

■ : Delik - Çentik

■ : Hole - Notch

■ : Trou - Entaille

NOT: Katalogdaki Orijinal Kodlar Referans Amacıyla Kullanılmıştır.Lütfen COTECH Kodlarını Kullanınız.
Original codes used for reference only.Please use COTECH codes for orders.

00



Silindir Kapak
Cylinder Head

01



Zylinderkopf

02



Joint de culasse

03



04

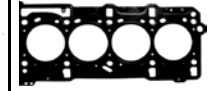

Ltr	MODEL	PS/KW	ENGINE/MOTOR		
1,0 956	4 CYL ø65 SUPER 5 10/84--> RAPID SUPERCINGO EXPRESS	42 PS / 31 KW 33 PS / 24 KW	C1C C1C 700 C1C 706 C1C 708 C1C 754	60157002 77 01 462 215 77 01 465 261	 60108005 77 00 680 688 1,20mm 60108006 77 00 680 688 1,80mm ø72
1,0 998	4 CYL ø69 LOGAN FLEX 16V (DOCH) 2007-->	75 PS / 55 KW 78 PS / 58 KW	D4DHIFLEX	60108703 77 01 475 822	 60108605 8200062273 MLS ø70
1,0 999	4 CYL ø69 CLIO KANGOO TWINGO 1999-->	59 PS / 43 KW	D7D		 60108805 77 00 864 736 1,40mm ø70,2
1,0 999	4 CYL ø69 CLIO 16V 2000--> KANGOO 16V 2003--> (DOCH)	60 PS / 44 KW	D4D 700 D4D 720	60108603 77 01 473 003	 60108605 8200062273 MLS ø70
1,1 1108	4 CYL ø70 R 8 05/66-->10/72 R 10	45 PS / 33 KW	689		 60108005 77 00 680 688 1,20mm 60108006 77 00 680 688 1,80mm ø72

▲ : İçerikte Bulunmamaktadır...

▲ : Not included in the set

▲ : Non inclus dans la pochette

00: Motor Takım Keçesiz ve Subap Lastiksiz











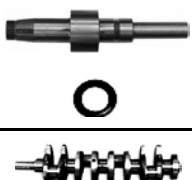
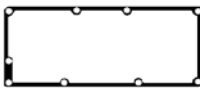





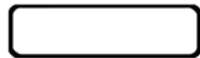

00: Gasket Set Without oil seals Without Valve Stem Seal

01: Motor Takım Keçesiz - Subap Lastikli

01: Gasket set With Valve Stem Seal Without Oil Seals

02: Motor Full Takım Keçeli ve Subap Lastikli

02: Gasket Full Set With oil seals and Valve Stem Seals

Subap Kapak Valve Cover Gasket Zylinderkopfhaube Couvre-culbut.	Karter Oil Pan Ölwanne Carter d'huile	Emme Manifold Intake Manifold Ansaug Admission	Egzoz Manifold Exhaust Manifold Auspuffkrümmer Collecteur D'echappement	Eksoz Boğaz Exhaust Pipe Auspuff Kehle	Supap Keçesi Valve Stem Seal Ventilschaft Queue de soupape	
						
 6,5mm 60102525 77 01 348 574	 60102268x4 77 00 564 813	 60103020 77 00 855 962			 60116026x8 77 00 736 465 7x9,8/13.2x10	21208067 35x50x10 RD 21201034 80x100x13 LD
 60108725 77 01 059 314		 60108618 77 01 473 007	 60108621 77 00 115 971		 60108726x16 82 00 171 215 5,5x8,3x11,5x8	21204701 28x47x8 RD
 60108625 77 01 049 888		 60108618 77 01 473 007	 60108621 77 00 115 971		 60108626x16 5,5x11x23x15,7	21204701 28x47x8 RD

 : Delik - Çentik

 : Hole - Notch

 : Trou - Entaille

NOT: Katalogdaki Orijinal Kodlar Referans Amacıyla Kullanılmıştır.Lütfen COTECH Kodlarını Kullanınız.
Original codes used for reference only.Please use COTECH codes for orders.

00



01



02



03



04



Silindir Kapak
Cylinder Head
Zylinderkopf
Joint de culasse



Ltr	MODEL	PS/KW	ENGINE/MOTOR		
1,1 1108	4 CYL ø70 RODEO 5 08/70--> RODEO 6 R 4 R 5 R 6	56 PS / 41 KW 34 PS / 25 KW	688 688 02 688 711 688 712 688 713 688.10 C1E / 688 C1E 714 C1E 718 C1E 719	60108002 77 01 459 391	 60108005 77 00 680 688 1,20mm 60108006 77 00 680 688 1,80mm ø72
1,2 1149	4 CYL ø69 CLIO 16V 2000--> KANGOO 16V SANDERO 16V 2009--> (DOCH)	75 PS / 55 KW	D4D 700 D4D 712 D4D	60108603 77 01 473 003	 60108605 8200062273 MLS ø70

▲ : İçerikte Bulunmamaktadır...

▲ : Not included in the set

▲ : Non inclus dans la pochette

00: Motor Takım Keçesiz ve Subap Lastiksiz











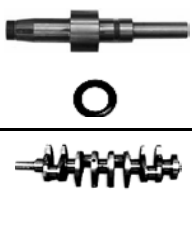
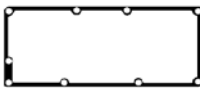



00: Gasket Set Without oil seals Without Valve Stem Seal

01: Motor Takım Keçesiz - Subap Lastikli

01: Gasket set With Valve Stem Seal Without Oil Seals

02: Motor Full Takım Keçeli ve Subap Lastikli

02: Gasket Full Set With oil seals and Valve Stem Seals

Subap Kapak Valve Cover Gasket Zylinderkopfhaube Couvre-culbut.	Karter Oil Pan Ölwanne Carter d'huile	Emme Manifold Intake Manifold Ansaug Admission	Egzoz Manifold Exhaust Manifold Auspuffkrümmer Collecteur D'echappement	Eksoz Boğaz Exhaust Pipe Auspuff Kehle	Supap Keçesi Valve Stem Seal Ventilschaft Queue de soupape	
						
 5,00mm 60101525 77 00 723 967	 60101265 77 01 453 950	 60101020 77 00 559 702				21208003 30x42x7 RD
						21201034 80x100x13 LD
 60108625 77 01 049 888		 60108618 77 01 473 007	 60108621 77 00 115 971		 60108626x16 5,5x11x23x15,7	21204701 28x47x8 RD

 : Delik - Çentik

 : Hole - Notch

 : Trou - Entaille

NOT: Katalogdaki Orijinal Kodlar Referans Amacıyla Kullanılmıştır.Lütfen COTECH Kodlarını Kullanınız.
Original codes used for reference only.Please use COTECH codes for orders.

00



01



02



03



04



Silindir Kapak
Cylinder Head
Zylinderkopf
Joint de culasse

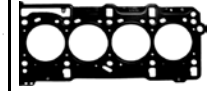

Ltr	MODEL	PS/KW	ENGINE/MOTOR		
1,1 1108	4 CYL ø70 CLIO RAPID SUPER 5 11 19 9	09/81-->09/98 49 PS / 36 KW 45 PS / 33 KW	C1E 700 C1E 715 C1E 720 C1E 750 C1E 752 C1E 754 C1E 756 C1E 760 C1E 762 C1E 792	60157002 77 01 462 215 77 01 465 261	 60108005 77 00 680 688 1,20mm 60108006 77 00 680 688 1,80mm ø72
1,2 1149	4 CYL ø69 TWINGO 16V CLIO 16V KANGOO 16V THALIA	01/01--> 75 PS / 55 KW 06/01--> 75 PS / 55 KW	D4F 702 D4F 704 D4F 706 D4F 712 D4F 714 D4F 716	60108602 77 01 473 003 77 01 473 503 60108603 77 01 473 003 60108604 77 01 473 503	 60108605 8200062273 MLS ø70
1,2 1149	4 CYL ø69 CLIO CLIO 16V MODUS MODUS 16V TWINGO TWINGO 16V	08/04--> 76 PS / 56 KW 60 PS / 44 KW	D4F 708 D4F 722 D4F 728 D4F 730 D4F 740 D4F 772	60108702 77 01 475 822 77 01 473 503 60108703 77 01 475 822 60108604 77 01 473 503	 60108605 8200062273 MLS ø70
1,2 1149	4 CYL ø69 CLIO CLIO 16V MODUS	12/04--> 78 PS / 58 KW 78 PS / 57 KW	D4F 764	60108503 77 01 476 731	 60108605 8200062273 MLS ø70
1,2 1149	4 CYL ø69 CLIO KANGOO THALIA TWINGO	01/96--> 60 PS / 44 KW 54 PS / 40 KW	D7D 760 D7F 700 D7F 701 D7F 702 D7F 703 D7F 704 D7F 706 D7F 710 D7F 720 D7F 722 D7F 726 D7F 730 D7F 744 D7F 746	60108802 77 01 472 955 77 00 866 465 60108803 77 01 472 955	 60108805 77 00 864 736 1,40mm ø70,2

▲ : İçerikte Bulunmamaktadır...

▲ : Not included in the set

▲ : Non inclus dans la pochette

00: Motor Takım Keçesiz ve Subap Lastiksiz











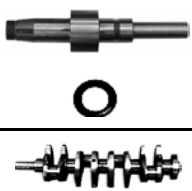
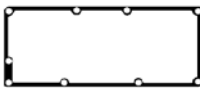





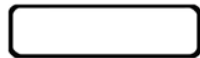









00: Gasket Set Without oil seals Without Valve Stem Seal

01: Motor Takım Keçesiz - Subap Lastikli

01: Gasket set With Valve Stem Seal Without Oil Seals

02: Motor Full Takım Keçeli ve Subap Lastikli

02: Gasket Full Set With oil seals and Valve Stem Seals

Subap Kapak Valve Cover Gasket Zylinderkopfhaube Couvre-culbut.	Karter Oil Pan Ölwanne Carter d'huile	Emme Manifold Intake Manifold Ansaug Admission	Egzoz Manifold Exhaust Manifold Auspuffkrümmer Collecteur D'echappement	Eksoz Boğaz Exhaust Pipe Auspuff Kehle	Supap Keçesi Valve Stem Seal Ventilschaft Queue de soupape	
						
 6,5mm 60102525 77 01 348 574	 60102268x4 77 00 564 813	 60103020 77 00 855 962			 60116026x8 77 00 736 465 7x9,8/13.2x10	21208067 35x50x10 RD 21201034 80x100x13 LD
 60108625 77 01 049 888		 60108618 77 01 473 007	 60108621 77 00 115 971		 60108626x16 5,5x11x23x15,7	21204701 28x47x8 RD 21201505 32x44x6 RD 21201510 70x86x7
 60108725 77 01 059 314		 60108618 77 01 473 007	 60108621 77 00 115 971		 60108726x16 82 00 171 215 5,5x8,3x11,5x8	21204701 28x47x8 RD 21201505 32x44x6 RD 21201510 70x86x7
 60108725 77 01 059 314		 60108618 77 01 473 007	 60108621 77 00 115 971		 60108726x16 82 00 171 215 5,5x8,3x11,5x8	21204025 35x47x7 RD
 60108825 77 00 106 172	 60108813 77 00 866 465	 60108818x2 77 01 204 945	 60108821 77 00 866 689		 60108827x8 77 00 862 483 6x10,9x28,2x20	21208003 30x42x7 RD 21201117 32x44x6 RD 21201147 70x86x8 LD

■ : Delik - Çentik

■ : Hole - Notch

■ : Trou - Entaille

NOT: Katalogdaki Orijinal Kodlar Referans Amacıyla Kullanılmıştır.Lütfen COTECH Kodlarını Kullanınız.
Original codes used for reference only.Please use COTECH codes for orders.

00



01



02



03



04



Silindir Kapak
Cylinder Head
Zylinderkopf
Joint de culasse

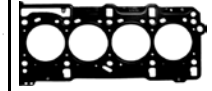

Ltr	MODEL	PS/KW	ENGINE/MOTOR		
1,2 1149	4 CYL ø69 KANGOO 07/98-->07/01 TWINGO 03/07-->	60 PS / 44 KW 58 PS / 43 KW	D7F 764 D7F 800		 60108805 77 00 864 736 1,40mm ø70,2
1,2 1171	4 CYL ø75,8 CLIO 05/90--> RAPID	65 PS / 44 KW 54 PS / 40 KW	E5F 710 E5F 716 E7F 700 E7F 704 E7F 706 E7F 708 E7F 730 E7F 750	60116002 Motor Full Takım Gasket Full Set 60116003 77 01 468 142 60116004 Alt Takım Conversion Set	 60116005 77 00 273 786 1,40mm 60116009 77 00 739 302 1,80mm ø77
1,2 1237	4 CYL ø71,5 RAPID 10/84-->12/96 SUPER 5 11 19 9	60 PS / 44 KW 54 PS / 40 KW	C1G C1G 700 C1G 702 C1G 710 C1G 720 C1G 722 C1G 726 C1G 730	▲ 60103001 Motor Takım Gasket Set 60103002 Motor Full Takım Gasket Full Set 60103003 77 01 462 216	 60102005 77 00 680 689 1,20mm 60102006 77 00 680 689 1,40mm 60102009 77 00 680 689 1,80mm ø77
1,3 1289	4 CYL ø73 12 08/69--> 12 TS ESTAFETTE RODEO 5 5	68 PS / 49 KW 39 PS / 29 KW	810 01 810 02 810 2/97 810 06 810 719 810 725 810 726 810 729 810 96 810 97	▲ 60101001 Motor Takım Gasket Set 60101002 77 01 452 153	 60101005 77 00 576 242 1,20mm 60101009 77 00 576 242 1,80mm ø74,3

▲ : İçerikte Bulunmamaktadır...

▲ : Not included in the set

▲ : Non inclus dans la pochette

00: Motor Takım Keçesiz ve Subap Lastiksiz











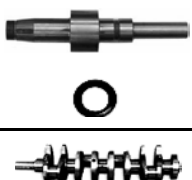
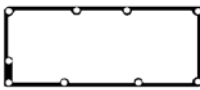





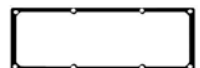

00: Gasket Set Without oil seals Without Valve Stem Seal

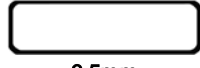
01: Motor Takım Keçesiz - Subap Lastikli

01: Gasket set With Valve Stem Seal Without Oil Seals

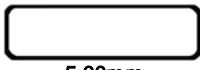
02: Motor Full Takım Keçeli ve Subap Lastikli

02: Gasket Full Set With oil seals and Valve Stem Seals

Subap Kapak Valve Cover Gasket Zylinderkopfhaube Couvre-culbut.	Karter Oil Pan Ölwanne Carter d'huile	Emme Manifold Intake Manifold Ansaug Admission	Egzoz Manifold Exhaust Manifold Auspuffkrümmer Collecteur D'echappement	Eksoz Boğaz Exhaust Pipe Auspuff Kehle	Supap Keçesi Valve Stem Seal Ventilschaft Queue de soupape	
						
 60116527 77 00 739 165	 60116265 77 00 739 392	 60116021 77 00 746 591	 60116020 77 00 854 041		 60116026x8 77 00 736 465 7x9,8/13.2x10	21204004 30x42x7 RD
						21208001 35x47x7 RD
						21208012 80x100x8 LD
 6,5mm 60102525 77 01 348 574	 60102265 77 01 457 561	 60103020 77 00 855 962			 ▲ 60103027x8 77 00 658 325 7x10,8x13x9,8	▲ 21208067 35x50x10 RD
						▲ 21201034 80x100x13 LD
 5,00mm 60101525 77 00 723 967	 60101265 77 01 453 950	 60101020 77 00 559 702		 60101017 77 00 502 706	▲	21201011 35x50x8 RD
						21201031 70x90x10 LD

■ : Delik - Çentik

■ : Hole - Notch

■ : Trou - Entaille

NOT: Katalogdaki Orijinal Kodlar Referans Amacıyla Kullanılmıştır.Lütfen COTECH Kodlarını Kullanınız.
Original codes used for reference only.Please use COTECH codes for orders.

00



Silindir Kapak

Cylinder Head

01



Zylinderkopf

02



Joint de culasse

03



04



Ltr	MODEL	PS/KW	ENGINE/MOTOR		
1,3 1289	4 CYL ø73 R 5 R 5 Automatic RODEO 09/75-->09/84	64 PS / 47 KW 54 PS / 40 KW 45 PS / 33 KW	810 810.19 810 719 810 725 810 729	60123002 77 01 457 752	 60101005 77 00 576 242 1,20mm 60101006 77 00 576 242 1,80mm ø74,3
1,4 1390	4 CYL ø75,8 CLIO RAPID 19 01/88-->	80 PS / 59 KW 58 PS / 43 KW	E6J 700 E6J 701 E6J 706 E6J 712 E6J 713 E6J 718 E6J 734 E6J 738 E6J 760 E7J 601 E7J 700 E7J 706 E7J 710 E7J 711 E7J 718 E7J 719 E7J 720 E7J 724 E7J 726 E7J 728 E7J 742 E7J 745 E7J 754 E7J 756 E7J 757 E7J 773	60116002 Motor Full Takım Gasket Full Set 60116003 77 01 468 142 60116004 Alt Takım Conversion Set	 60116005 77 00 273 786 1,40mm 60116006 77 00 739 302 1,80mm ø77

▲ : İçerikte Bulunmamaktadır...

▲ : Not included in the set

▲ : Non inclus dans la pochette

00: Motor Takım Keçesiz ve Subap Lastiksiz











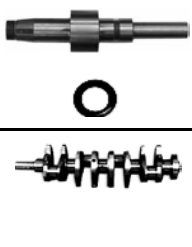
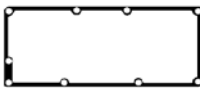



00: Gasket Set Without oil seals Without Valve Stem Seal

01: Motor Takım Keçesiz - Subap Lastikli

01: Gasket set With Valve Stem Seal Without Oil Seals

02: Motor Full Takım Keçeli ve Subap Lastikli

02: Gasket Full Set With oil seals and Valve Stem Seals

Subap Kapak Valve Cover Gasket Zylinderkopfhaube Couvre-culbut.	Karter Oil Pan Ölwanne Carter d'huile	Emme Manifold Intake Manifold Ansaug Admission	Egzoz Manifold Exhaust Manifold Auspuffkrümmer Collecteur D'echappement	Eksoz Boğaz Exhaust Pipe Auspuff Kehle	Supap Keçesi Valve Stem Seal Ventilschaft Queue de soupape	
						
 5,00mm 60101525 77 00 723 967	 60102265 77 01 457 561	 60101020 77 00 559 702			▲	21204004 30x42x7 RD 21201031 70x90x10 LD
 60116527 77 00 739 165	 60116265 77 00 739 392	 60116021 77 00 746 591	 60116020 77 00 746 591		 60116026x8 77 00 736 465 7x9,8/13.2x10	21204004 30x42x7 RD 21208001 35x47x7 RD 21208012 80x100x8 LD

■ : Delik - Çentik

■ : Hole - Notch

■ : Trou - Entaille

NOT: Katalogdaki Orijinal Kodlar Referans Amacıyla Kullanılmıştır.Lütfen COTECH Kodlarını Kullanınız.
Original codes used for reference only.Please use COTECH codes for orders.

00



Silindir Kapak
Cylinder Head

01



Zylinderkopf

02



Joint de culasse

03



04

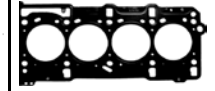

Ltr	MODEL	PS/KW	ENGINE/MOTOR		
1,4 1390	4 CYL ø75,8 CLIO 03/98--> CLIO 10/98-->05/05 KANGOO 09/97--> MEGANE 03/99--> MEGANE 11/95-->06/97 SCENIC 11/95-->06/97	75 PS / 55 KW 75 PS / 55 KW 75 PS / 55 KW 75 PS / 55 KW 75 PS / 55 KW 75 PS / 55 KW	E7J 780 E7J 635 - E7J 635 E7J 634 - E7J 780 E7J 626 - E7J 634 E7J 624 - E7J 764 E7J 624 - E7J 764	60116102 Motor Full Takım Gasket Full Set 60116103 77 01 468 709 60116104 Alt Takım Conversion Set	 60116005 77 00 273 786 1,40mm 60116009 77 00 739 302 1,80mm ø77
1,4 1390	4 CYL ø79,5 CLIO 16V 03/99--> MEGANE 16V MEGANE Grandtour 16V MODUS SCÉNIC 16V THALIA 16V MEGANE 11/02--> MEGANE 16V SCÉNIC	98 PS / 72 KW 95 PS / 70 KW 98 PS / 72 KW 82 PS / 60 KW	K4J K4J 700 K4J 710 K4J 711 K4J 712 K4J 713 K4J 714 K4J 715 K4J 750 K4J 770 K4J 780 K4J 730 K4J 732 K4J 740	62457202 Motor Full Takım Gasket Full Set 62457203 77 01 471 886 62457204 Alt Takım Conversion Set	 62457205 77 00 112 739 MLS ø80,5
1,4 1390	4 CYL ø79,5 SCENIC16V 06/03--> MEGANE 16V 08/03--> MODUS 16V 06/05--> CLIO 16V 06/05-->	98 PS / 72 KW	K4J 740 K7J 780	62456502 Motor Takım Gasket Full Set 62457203 77 01 471 886 62457404 Alt Takım Conversion Set	 62457205 77 00 112 739 MLS ø80,5

▲ : İçerikte Bulunmamaktadır...

▲ : Not included in the set

▲ : Non inclus dans la pochette

00: Motor Takım Keçesiz ve Subap Lastiksiz











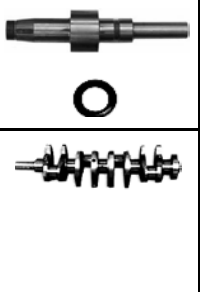
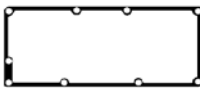













00: Gasket Set Without oil seals Without Valve Stem Seal

01: Motor Takım Keçesiz - Subap Lastikli

01: Gasket set With Valve Stem Seal Without Oil Seals

02: Motor Full Takım Keçeli ve Subap Lastikli

02: Gasket Full Set With oil seals and Valve Stem Seals

Subap Kapak Valve Cover Gasket Zylinderkopfhaube Couvre-culbut.	Karter Oil Pan Ölwanne Carter d'huile	Emme Manifold Intake Manifold Ansaug Admission	Egzoz Manifold Exhaust Manifold Auspuffkrümmer Collecteur D'echappement	Eksoz Boğaz Exhaust Pipe Auspuff Kehle	Supap Keçesi Valve Stem Seal Ventilschaft Queue de soupape	
						
 60116527 77 00 739 165	 ø7 60116165	 60108918x4 77 01 471 932	 60149020 77 00 867 360		 60116026x8 77 00 736 465 7x9,8/13.2x10	21204004 30x42x7 RD
		 60149018x4 77 01 471 816				21208001 35x47x7 RD
		 60116019 77 00 273 827				21208012 80x100x8 LD
		 60116021 77 00 746 591				
	 62457265 77 00 103 687	 62457218x4 82 00 052 312	 62457221 77 00 107 181		 62457244x16 77 00 103 938 5,5x11x28x16,4	21204024x2 28x42x5 RD
		 62457219 77 00 105 852				21204005 35x47x7 RD
						21204009 80x100x8 LD
	 62457065 82 00 379 654	 62457218x4 82 00 052 312	 62457221 77 00 107 181		 62457244x16 77 00 103 938 5,5x11x28x16,4	21204024x2 28x42x5 RD
		 62457219 77 00 105 852				21204005 35x47x7 RD
						21204009 80x100x8 LD

■ : Delik - Çentik

■ : Hole - Notch

■ : Trou - Entaille

NOT: Katalogdaki Orijinal Kodlar Referans Amacıyla Kullanılmıştır.Lütfen COTECH Kodlarını Kullanınız.
Original codes used for reference only.Please use COTECH codes for orders.

00



01



02



03



04



Silindir Kapak
Cylinder Head
Zylinderkopf
Joint de culasse

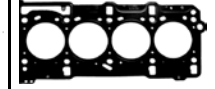

Ltr	MODEL	PS/KW	ENGINE/MOTOR		
1,4 1390	4 CYL ø79,5 LOGAN 09/04-->	75 PS / 55 KW	K7J 710	60108902 Motor Full Takım Gasket Full Set	60108905 82 00 296 969 1,20mm FIBER / FIBRE 60108906 82 00 296 969 MLS ø80,5
1,4 1390	4 CYL ø79,5 SYMBOL THALIA 08/08--> CLIO 08/97--> KANGOO	75 PS / 55 KW 75 PS / 55 KW	K7J 700 K7J 700 K7J 700 K7J 701	60149002 Motor Full Takım Gasket Full Set	60149005 77 00 866 683 1,40mm 60149006 77 00 866 683 1,60mm ø80
1,4 1397	4 CYL ø76 R 12 TS 01/76-->12/80 R 5 TX	63 PS / 46 KW 59 PS / 43 KW	847.05 847.06 847.07	60102002 77 01 458 695	60102005 77 00 680 689 1,20mm ▲ 60102001 77 01 458 695 60102006 77 00 680 689 1,40mm 60102009 77 00 680 689 1,80mm ø77

▲ : İçerikte Bulunmamaktadır...

▲ : Not included in the set

▲ : Non inclus dans la pochette

00: Motor Takım Keçesiz ve Subap Lastiksiz











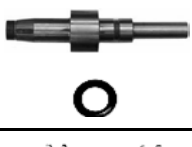
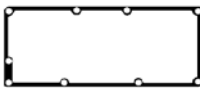







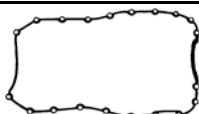

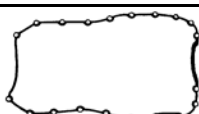

00: Gasket Set Without oil seals Without Valve Stem Seal

01: Motor Takım Keçesiz - Subap Lastikli

01: Gasket set With Valve Stem Seal Without Oil Seals

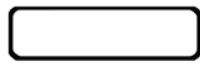
02: Motor Full Takım Keçeli ve Subap Lastikli

02: Gasket Full Set With oil seals and Valve Stem Seals

Subap Kapak Valve Cover Gasket Zylinderkopfhaube Couvre-culbut.	Karter Oil Pan Ölwanne Carter d'huile	Emme Manifold Intake Manifold Ansaug Admission	Egzoz Manifold Exhaust Manifold Auspuffkrümmer Collecteur D'echappement	Eksoz Boğaz Exhaust Pipe Auspuff Kehle	Supap Keçesi Valve Stem Seal Ventilschaft Queue de soupape	
						
						21208003 30x42x7 RD
60116527 77 01 471 719	62457165 77 00 273 486	60108918x4 77 01 471 932	60108921 8200191371		60116026x8 77 00 103 872 7x9,8/13.2x10	21208001 35x47x7 RD
						21208003 30x42x7 RD
60116527 77 01 471 719	62457165 77 00 273 486	60108918x4 77 01 471 932	60149020 77 00 867 360		60116026x8 77 00 103 872 7x9,8/13.2x10	21208001 35x47x7 RD
						21208012 80x100x8 LD
		60149018x4 77 01 471 816				
						
		60149019 77 00 865 764				
						▲21201011 35x50x8 RD
6,5mm 60102525 77 01 348 574	60102265 77 01 457 561	60101020 77 00 559 702	60101017 77 00 502 706			▲21201034 80x100x13 LD

■ : Delik - Çentik

■ : Hole - Notch

■ : Trou - Entaille

NOT: Katalogdaki Orijinal Kodlar Referans Amacıyla Kullanılmıştır.Lütfen COTECH Kodlarını Kullanınız.
Original codes used for reference only.Please use COTECH codes for orders.

00



01



02



03



04



Silindir Kapak
Cylinder Head
Zylinderkopf
Joint de culasse

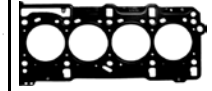

Ltr	MODEL	PS/KW	ENGINE/MOTOR		
1,4 1397	4 CYL ø76 R 18 03/80-->04/89 TRAFIC 03/80-->06/91 FUEGO 02/80-->10/85	64 PS / 47 KW 48 PS / 35 KW 64 PS / 47 KW	847.20 / C1J 847.700 847.701 C1J.700 847.720	60125002 77 01 460 626	 60102005 77 00 680 689 1,20mm 60102006 77 00 680 689 1,40mm 60102009 77 00 680 689 1,80mm ø77
1,4 1397	4 CYL ø76 R 9 08/76--> R 11 R 12 R 19 R 21 SUPERCINGO SUPER 5 RAPID	72 PS / 53 KW 58 PS / 43 KW	C1J 715 C2J 717 C2J 718 C2J 720 C2J 730 C2J 756 C2J 766 C2J 768 C3J 700 C3J 702 C3J 710 C3J 756 C3J 760 C3J 762	▲ 60103001 Motor Takım Gasket Set 60103002 Motor Full Takım Gasket Full Set 60103003 77 01 462 216	 60102005 77 00 680 689 1,20mm 60102006 77 00 680 689 1,40mm 60102009 77 00 680 689 1,80mm ø77
1,4 1397	4 CYL ø76 R 9 08/76--> R 11 R 12 R 19 R 21 SUPERCINGO SUPER 5 RAPID	72 PS / 53 KW 58 PS / 43 KW	C1J 715 C2J 717 C2J 718 C2J 720 C2J 730 C2J 756 C2J 766 C2J 768 C3J 700 C3J 702 C3J 710 C3J 756 C3J 760 C3J 762	▲ 60103101 Motor Takım Gasket Set 60103102 Motor Full Takım Gasket Full Set 60103003 77 01 462 216	 60102005 77 00 680 689 1,20mm 60102006 77 00 680 689 1,40mm 60102009 77 00 680 689 1,80mm ø77

▲ : İçerikte Bulunmamaktadır...

▲ : Not included in the set

▲ : Non inclus dans la pochette

00: Motor Takım Keçesiz ve Subap Lastiksiz











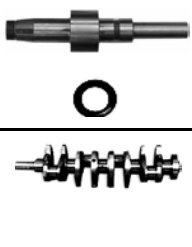
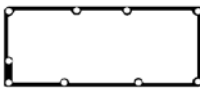



00: Gasket Set Without oil seals Without Valve Stem Seal

01: Motor Takım Keçesiz - Subap Lastikli

01: Gasket set With Valve Stem Seal Without Oil Seals

02: Motor Full Takım Keçeli ve Subap Lastikli

02: Gasket Full Set With oil seals and Valve Stem Seals

Subap Kapak Valve Cover Gasket Zylinderkopfhaube Couvre-culbut.	Karter Oil Pan Ölwanne Carter d'huile	Emme Manifold Intake Manifold Ansaug Admission	Egzoz Manifold Exhaust Manifold Auspuffkrümmer Collecteur D'echappement	Eksoz Boğaz Exhaust Pipe Auspuff Kehle	Supap Keçesi Valve Stem Seal Ventilschaft Queue de soupape	
						
6,5mm 60102525 77 01 348 574	 60102265 77 01 457 561	 60101020 77 00 559 702				21208067 35x50x10 RD 21201034 80x100x13 LD
6,5mm 60102525 77 01 348 574	 60102265 77 01 457 561	 60103020 77 00 855 962			 ▲ 60103027x8 77 00 658 325 7x10,8x13x9,8	▲ 21208067 35x50x10 RD ▲ 21201034 80x100x13 LD
6,5mm 60102525 77 01 348 574	 60102268x4 77 00 564 813	 60103020 77 00 855 962			 ▲ 60103027x8 77 00 658 325 7x10,8x13x9,8	▲ 21208067 35x50x10 RD ▲ 21201034 80x100x13 LD

■ : Delik - Çentik

■ : Hole - Notch

■ : Trou - Entaille

NOT: Katalogdaki Orijinal Kodlar Referans Amacıyla Kullanılmıştır.Lütfen COTECH Kodlarını Kullanınız.
Original codes used for reference only.Please use COTECH codes for orders.

00



01



02



03



04



Silindir Kapak
Cylinder Head
Zylinderkopf
Joint de culasse

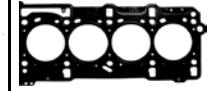

Ltr	MODEL	PS/KW	ENGINE/MOTOR		
1,4 1397	4 CYL ø76 SUPER 02/84-->08/90 SUPER 5 SUPER 5 Turbo 11 11 Turbo 9 Turbo	120 PS / 88 KW 105 PS / 77 KW	C1J 760 C1J 764 C1J 770 C1J 782 C1J 784 C1J 788	60107602 77 01 465 268	 60107605 77 00 733 041 1,40mm ø77
1,5 1461	4 CYL ø76 CLIO dCi 06/01--> CLIO DCI KANGOO DCI SCÉNIC DCI THALIA THALIA dCi THALIA DCI	82 PS / 60 KW 65 PS / 48 KW	K9K 700 K9K 702 K9K 704 K9K 710 K9K 722	62457102 Motor Full Takım Gasket Full Set 62457103 77 01 473 371 62457104 Motor Alt Takım Conversion Set	 62457105 82 00 071 111 0,60mm 62457106 82 00 071 111 0,82mm MLS ø77,5
1,5 1461	4 CYL ø76 CLIO 12/04--> CLIO dCi MODUS THALIA dCi TWINGO dCi CLIO dCi 11/03--> MEGANE DCI 11/02--> SCÉNIC DCI	82 PS / 60 KW 64 PS / 47 KW 82 PS / 60 KW 86 PS / 63 KW 82 PS / 60 KW	K9K 706 K9K 740 K9K 750 K9K 752 K9K 790 K9K 716 K9K 722	62456902 Motor Full Takım Gasket Full Set 62457003 77 01 476 729 62457104 Motor Alt Takım Conversion Set	 62457005 82 00 351 353 0,70mm 62457006 82 00 351 353 0,82mm MLS ø77,5
1,5 1461	4 CYL ø76 CLIO DCI 11/03--> GRAND SCÉNIC dCi GRAND SCÉNIC DCI MEGANE dCi MEGANE DCI SCÉNIC dCi SCÉNIC DCI	106 PS / 78 KW 100 PS / 74 KW	K9K 712 K9K 728	62457002 Motor Full Takım Gasket Full Set 62457003 77 01 476 729 62457004 Motor Alt Takım Conversion Set	 62457005 82 00 351 353 0,70mm 62457006 82 00 351 353 0,82mm MLS ø77,5

▲ : İçerikte Bulunmamaktadır...

▲ : Not included in the set

▲ : Non inclus dans la pochette

00: Motor Takım Keçesiz ve Subap Lastiksiz











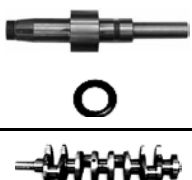
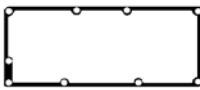



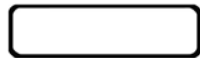

00: Gasket Set Without oil seals Without Valve Stem Seal

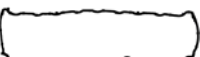
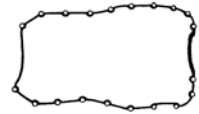
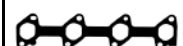
01: Motor Takım Keçesiz - Subap Lastikli

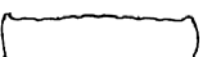
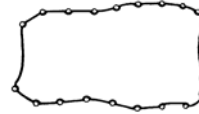
01: Gasket set With Valve Stem Seal Without Oil Seals

02: Motor Full Takım Keçeli ve Subap Lastikli

02: Gasket Full Set With oil seals and Valve Stem Seals

Subap Kapak Valve Cover Gasket Zylinderkopfhaube Couvre-culbut.	Karter Oil Pan Ölwanne Carter d'huile	Emme Manifold Intake Manifold Ansaug Admission	Egzoz Manifold Exhaust Manifold Auspuffkrümmer Collecteur D'echappement	Eksoz Boğaz Exhaust Pipe Auspuff Kehle	Supap Keçesi Valve Stem Seal Ventilschaft Queue de soupape	
						
 6,5mm 60102525 77 01 348 574	 60102267 77 00 564 813	 60103020 77 00 855 962				21208067 35x50x10 RD 21201034 80x100x13 LD
 62457125 82 00 117 388	 62457165 77 00 273 486		 62457121 82 00 128 551		 62457144x8 77 00 109 840 6x8,8x12,2x9,7	21204024 28x42x5 RD 21204025 35x47x7 RD 21204033 80x100x9 LD
 62457125 82 00 117 388	 62457165 77 00 273 486		 62457021 82 00 414 346		 62457144x8 77 00 109 840 6x8,8x12,2x9,7	21204024 28x42x5 RD 21204025 35x47x7 RD 21204033 80x100x9 LD
 62457125 82 00 117 388	 62457065 82 00 379 654		 62457021 82 00 414 346		 62457144x8 77 00 109 840 6x8,8x12,2x9,7	21204024 28x42x5 RD 21204025 35x47x7 RD 21204033 80x100x9 LD

■ : Delik - Çentik

■ : Hole - Notch

■ : Trou - Entaille

NOT: Katalogdaki Orijinal Kodlar Referans Amacıyla Kullanılmıştır.Lütfen COTECH Kodlarını Kullanınız.
Original codes used for reference only.Please use COTECH codes for orders.

00



Silindir Kapak
Cylinder Head
Zylinderkopf
Joint de culasse

01



02



03



04



Ltr	MODEL	PS/KW	ENGINE/MOTOR		
1,5 1461	4 CYL ø76 CLIO DCI 02/09--> CLIO Grandtour DCI FLUENCE DCI KANGOO DCI MEGANE DCI MODUS DCI SCÉNIC DCI	110 PS / 81 KW 75 PS / 55 KW	K9K 770 K9K 808 K9K 834 K9K 836 K9K 837 K9K 846	62457503 77 01 479 013	 62457505 11 04 470 55R 0,85mm MLS ø77,5

▲ : İçerikte Bulunmamaktadır...

▲ : Not included in the set

▲ : Non inclus dans la pochette

00: Motor Takım Keçesiz ve Subap Lastiksiz







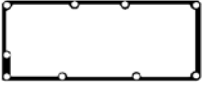
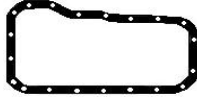

00: Gasket Set Without oil seals Without Valve Stem Seal

01: Motor Takım Keçesiz - Subap Lastikli

01: Gasket set With Valve Stem Seal Without Oil Seals

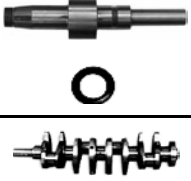
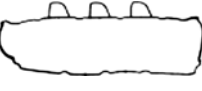
02: Motor Full Takım Keçeli ve Subap Lastikli

02: Gasket Full Set With oil seals and Valve Stem Seals

<p>Subap Kapak Valve Cover Gasket Zylinderkopfhaube Couvre-culbut.</p> 	<p>Karter Oil Pan Ölwanne Carter d'huile</p> 	<p>Emme Manifold Intake Manifold Ansaug Admission</p> 	<p>Egzoz Manifold Exhaust Manifold Auspuffkrümmer Collecteur D'echappement</p> 	<p>Eksoz Boğaz Exhaust Pipe Auspuff Kehle</p> 	<p>Supap Keçesi Valve Stem Seal Ventilschaft Queue de soupape</p> 	
 <p>62457525 77 01 070 607</p>	 <p>62457065 82 00 379 654</p>		 <p>62457021 82 00 414 346</p>		 <p>62457144x8 77 00 109 840 82 00 496 321 6x8,8x12,2x9,7</p>	<p>21204710 28x42x6 RD</p>
						<p>21204025 35x47x7 RD</p> <p>21204033 80x100x9 LD</p>

■ : Delik - Çentik

■ : Hole - Notch

■ : Trou - Entaille

NOT: Katalogdaki Orijinal Kodlar Referans Amacıyla Kullanılmıştır.Lütfen COTECH Kodlarını Kullanınız.
Original codes used for reference only.Please use COTECH codes for orders.

00



01



02



03



04



Silindir Kapak
Cylinder Head
Zylinderkopf
Joint de culasse

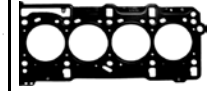

Ltr	MODEL	PS/KW	ENGINE/MOTOR		
1,5 1461	4 CYL ø76 CLIO 02/03--> CLIO D CLIO dCi CLIO DCI GRAND SCÉNIC DCI KANGOO dCi KANGOO DCI LOGAN LOGAN dCi MEGANE DCI MODUS dCi MODUS DCI SCÉNIC DCI THALIA TWINGO dCi LOGAN 02/08-->	103 PS / 76 KW 68 PS / 50 KW 86 PS / 63 KW	K9K 714 K9K 718 K9K 724 K9K 729 K9K 760 K9K 762 K9K 766 K9K 768 K9K 772 K9K 792 K9K 800 K9K 802 K9K 796	62457002 Motor Full Takım Gasket Full Set 62457003 77 01 476 729 62457004 Motor Alt Takım Conversion Set	 62457005 82 00 351 353 0,70mm 62457006 82 00 351 353 0,82mm MLS ø77,5
1,5 1461	4 CYL ø76 CLIO dCi 05/05--> CLIO DCI GRAND SCÉNIC dCi KANGOO dCi MEGANE dCi MEGANE DCI MODUS DCI SCÉNIC dCi SCÉNIC DCI LAGUNA dCi 10/07-->	106 PS / 78 KW 103 PS / 76 KW 110 PS / 81 KW	K9K 732 K9K 734 K9K 764 K9K 804 K9K 806 K9K 832 K9K 780	62456802 Motor Full Takım Gasket Full Set 62456803 77 01 477 501 62457004 Motor Alt Takım Conversion Set	 62457005 82 00 351 353 0,70mm 62457006 82 00 351 353 0,82mm MLS ø77,5
1,6 1565	4 CYL ø77 R 16 TL 01/71-->08/80	54 PS / 40 KW	821 821.03 821.04	60109002 771451901	 60109005 77 01 450 286 ø78,7
1,6 1595	4 CYL ø78 9 D 10/82-->08/98 11 D RAPID D SUPER 5 SUPER 5 D	55 PS / 40 KW 54 PS / 40 KW	F8M 700 F8M 720 F8M 730 F8M 736 F8M 760	60104002 Motor Full Takım Gasket Full Set 60113003 77 01 462 816 60113004 77 01 462 817	 60104005 77 00 745 717 1,80mm ø79

▲ : İçerikte Bulunmamaktadır...

▲ : Not included in the set

▲ : Non inclus dans la pochette

00: Motor Takım Keçesiz ve Subap Lastiksiz











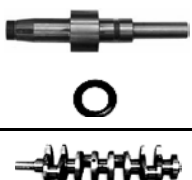
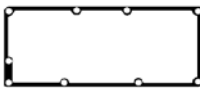



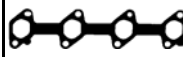

00: Gasket Set Without oil seals Without Valve Stem Seal

01: Motor Takım Keçesiz - Subap Lastikli

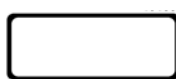
01: Gasket set With Valve Stem Seal Without Oil Seals

02: Motor Full Takım Keçeli ve Subap Lastikli

02: Gasket Full Set With oil seals and Valve Stem Seals

Subap Kapak Valve Cover Gasket Zylinderkopfhaube Couvre-culbut.	Karter Oil Pan Ölwanne Carter d'huile	Emme Manifold Intake Manifold Ansaug Admission	Egzoz Manifold Exhaust Manifold Auspuffkrümmer Collecteur D'echappement	Eksoz Boğaz Exhaust Pipe Auspuff Kehle	Supap Keçesi Valve Stem Seal Ventilschaft Queue de soupape	
						
62457125 82 00 117 388	62457065 82 00 379 654		62457021 82 00 414 346		62457144x8 77 00 109 840 6x8,8x12,2x9,7	21204024 28x42x5 RD
						21204025 35x47x7 RD
						21204033 80x100x9 LD
						21204024 28x42x5 RD
62457025 77 01 066 400	62457065 82 00 379 654		62457021 82 00 414 346		62457144x8 77 00 109 840 6x8,8x12,2x9,7	21204025 35x47x7 RD
						21204033 80x100x9 LD
						21201010 32x45x8 RD
60110525 77 00 725 186	60110265 7700710279	60109020 77 00 635 407				21201034 80x100x13 LD
						21204002 25x42x8 RD
60104525 77 00 719 666	60113265 77 00 859 751	60113021 77 00 103 849			60107027x8 77 00 737 124 8x10,8x14,2x10	21201027 50x68x10 RD
						21201038 85x105x8 LD

■ : Delik - Çentik

■ : Hole - Notch

■ : Trou - Entaille

NOT: Katalogdaki Orijinal Kodlar Referans Amacıyla Kullanılmıştır.Lütfen COTECH Kodlarını Kullanınız.
Original codes used for reference only.Please use COTECH codes for orders.

00



Silindir Kapak
Cylinder Head
Zylinderkopf
Joint de culasse

01



02



03



04

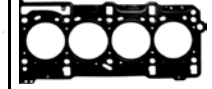

Ltr	MODEL	PS/KW	ENGINE/MOTOR		
1,6 1598	4 CYL ø79,5 CLIO 16V 11/97--> LAGUNA 16V MEGANE MEGANE Grandtour 16V MEGANE 16V SCÉNIC SCÉNIC 16V THALIA 16V CLIO 03/01--> KANGOO 16V LAGUNA 16V LAGUNA 06/01--> TWINGO	109 PS / 80 KW 90 PS / 66 KW 116 PS / 85 KW 95 PS / 70 KW 133 PS / 98 KW 103 PS / 76 KW	K4M 700 K4M 701 K4M 704 K4M 706 K4M 708 K4M 709 K4M 711 K4M 712 K4M 720 K4M 724 K4M 730 K4M 732 K4M 734 K4M 736 K4M 740 K4M 742 K4M 743 K4M 748 K4M 762 K4M 768 K4M 710 K4M 744 K4M 745 K4M 746 K4M 750 K4M 752 K4M 753 K4M 764 K4M 718 K4M 754	62457202 Motor Full Takım Gasket Full Set 62457203 77 01 471 886 62457204 Alt Takım Conversion Set	 62457205 77 00 112 739 MLS ø80,5
1,6 1598	4 CYL ø79,5 LAGUNA 16V 02/05--> MEGANE 11/02--> MEGANE 16V CLIO 06/03--> GRAND SCÉNIC MEGANE SCÉNIC MEGANE 01/07--> SCÉNIC KANGOO 02/08-->	112 PS / 82 KW 113 PS / 83 KW 112 PS / 82 KW 128 PS / 94 KW 109 PS / 81 KW 112 PS / 82 KW 106 PS / 78 KW	K4M 716 K4M 760 K4M 761 K4M 766 K4M 782 K4M 858 K4M 862 K4M 866 K4M 730	62456702 Motor Full Takım Gasket Full Set 62457403 77 01 474 372 62457204 Alt Takım Conversion Set	 62457205 77 00 112 739 MLS ø80,5

▲ : İçerikte Bulunmamaktadır...

▲ : Not included in the set

▲ : Non inclus dans la pochette

00: Motor Takım Keçesiz ve Subap Lastiksiz











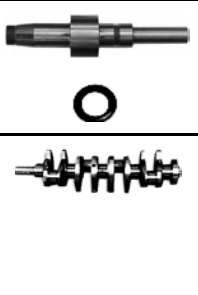

00: Gasket Set Without oil seals Without Valve Stem Seal

01: Motor Takım Keçesiz - Subap Lastikli

01: Gasket set With Valve Stem Seal Without Oil Seals

02: Motor Full Takım Keçeli ve Subap Lastikli

02: Gasket Full Set With oil seals and Valve Stem Seals

Subap Kapak Valve Cover Gasket Zylinderkopfhaube Couverculbut.	Karter Oil Pan Ölwanne Carter d'huile	Emme Manifold Intake Manifold Ansaug Admission	Egzoz Manifold Exhaust Manifold Auspuffkrümmer Collecteur D'echappement	Eksoz Boğaz Exhaust Pipe Auspuff Kehle	Supap Keçesi Valve Stem Seal Ventilschaft Queue de soupape	
	 62457265 77 00 103 687	 62457218x4 82 00 052 312  62457219 77 00 105 852	 62457221 77 00 107 181		 62457244x16 77 00 103 938 5,5x11x28x16,4	21204024x2 28x42x5 RD 21204005 35x47x7 RD 21204009 80x100x8 LD
	 62457265 77 00 103 687	 62457219 77 00 105 852  62457418x4 82 00 275 057	 62457221 77 00 107 181  62457222 82 00 365 915		 62457244x16 77 00 103 938 5,5x11x28x16,4	21208071 33x42x6 RD 21204024 28x42x5 RD 21204005 35x47x7 RD 21204009 80x100x8 LD

■ : Delik - Çentik

■ : Hole - Notch

■ : Trou - Entaille

NOT: Katalogdaki Orijinal Kodlar Referans Amacıyla Kullanılmıştır.Lütfen COTECH Kodlarını Kullanınız.
 Original codes used for reference only.Please use COTECH codes for orders.

00



Silindir Kapak
Cylinder Head

01



Zylinderkopf

02



Joint de culasse

03



04

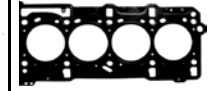

Ltr	MODEL	PS/KW	ENGINE/MOTOR		
1,6 1598	4 CYL ø79,5 MEGANE 01/96-->03/99 LOGAN KANGOO MEGANE Grandtour MEGANE Scenic THALIA	90 PS / 66 KW 75 PS / 55 KW	K7M 702 K7M 703 K7M 710 K7M 720 K7M 746 K7M 790	60149002 Motor Full Takım Gasket Full Set 60149003 77 01 468 710 60149004 Alt Takım Conversion Set	 60149005 77 00 866 683 1,40mm 60149006 77 00 866 683 1,60mm ø80
1,6 1598	4 CYL ø79,5 CLIO 09/98-->05/05 MEGANE	90 PS / 66 KW 87 PS / 64 KW	K7M 704 K7M 744 K7M 745	60149102 Motor Full Takım Gasket Full Set 60149103 Üst Takım Gasket Head Set 60149004 Alt Takım Conversion Set	 60149005 77 00 866 683 1,40mm 60149006 77 00 866 683 1,60mm ø80
1,6 1598	4 CYL ø79,5 GRAND SCÉNIC 06/05--> LOGAN MEGANE SCÉNIC	105 PS / 77 KW	K4M 690 K4M 788	62456602 Motor Full Takım Gasket Full Set 62456603 77 01 471 886 62457204 Alt Takım Conversion Set	 62457205 77 00 112 739 MLS ø80,5

▲ : İçerikte Bulunmamaktadır...

▲ : Not included in the set

▲ : Non inclus dans la pochette

00: Motor Takım Keçesiz ve Subap Lastiksiz











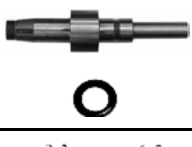
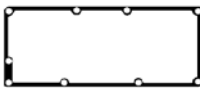







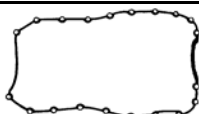





00: Gasket Set Without oil seals Without Valve Stem Seal

01: Motor Takım Keçesiz - Subap Lastikli

01: Gasket set With Valve Stem Seal Without Oil Seals

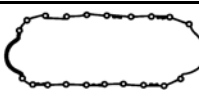
02: Motor Full Takım Keçeli ve Subap Lastikli

02: Gasket Full Set With oil seals and Valve Stem Seals

Subap Kapak Valve Cover Gasket Zylinderkopfhaube Couvre-culbut.	Karter Oil Pan Ölwanne Carter d'huile	Emme Manifold Intake Manifold Ansaug Admission	Egzoz Manifold Exhaust Manifold Auspuffkrümmer Collecteur D'echappement	Eksoz Boğaz Exhaust Pipe Auspuff Kehle	Supap Keçesi Valve Stem Seal Ventilschaft Queue de soupape	
						
		 60108918x4 77 01 471 932	 60149020 77 00 867 360		 60116026x8 77 00 103 872 7x9,8/13.2x10	21208003 30x42x7 RD
60116527 77 01 471 719	62457165 77 00 273 486	 60149018x4 77 01 471 816				21208001 35x47x7 RD
		 60149019 77 00 865 764				21208012 80x100x8 LD
		 60116019 77 00 273 827	 60149020 77 00 867 360		 60116026x8 77 00 103 872 7x9,8/13.2x10	21208003 30x42x7 RD
60116527 77 01 471 719	62457165 77 00 273 486	 60149018x4 77 01 471 816				21208001 35x47x7 RD
						21208012 80x100x8 LD
		 62457418x4 82 00 275 057	 62457222 82 00 365 915		 62457244x16 77 00 103 938 5,5x11x28x16,4	21204024x2 28x42x5 RD
	62457265 77 00 103 687	 62457219 77 00 105 852				21204005 35x47x7 RD
						21204009 80x100x8 LD

■ : Delik - Çentik

■ : Hole - Notch

■ : Trou - Entaille

NOT: Katalogdaki Orijinal Kodlar Referans Amacıyla Kullanılmıştır.Lütfen COTECH Kodlarını Kullanınız.
Original codes used for reference only.Please use COTECH codes for orders.

00



01



02



03



04



Silindir Kapak
Cylinder Head
Zylinderkopf
Joint de culasse

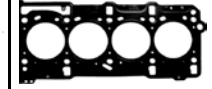

Ltr	MODEL	PS/KW	ENGINE/MOTOR		
1,6 1598	4 CYL ø79,5 CLIO 12/04--> CLIO 16V MODUS CLIO 12/04--> CLIO 16V MODUS TWINGO CLIO 16V 06/05-->	112 PS / 82 KW 133 PS / 98 KW 88 PS / 65 KW 88 PS / 65 KW	K4M 790 K4M 800 K4M 791 K4M 792 K4M 794 K4M 801 K4M 854 K4M 804	62457402 Motor Full Takım Gasket Full Set 62457403 77 01 474 372 62457404 Alt Takım Conversion Set	 62457205 77 00 112 739 MLS ø80,5
	4 CYL ø79,5 KANGOO 02/08--> LOGAN 09/04-->	105 PS / 77 KW 84 PS / 62 KW 87 PS / 64 KW	K7M 690 K7M 718 K7M 732 K7M 750 K7M 710	60108902 40108903+40149004 60108903 60 01 548 043 60149004 Motor Alt Takım Conversion Set	 60108905 82 00 296 969 1,20mm FIBER / FIBRE 60108906 82 00 296 969 MLS ø80,5
1,6	4 CYL ø76 21 OPTIMA FAIRWAY		C2L C3L	60107602 77 01 465 268	 60107605 77 00 733 041 1,40mm ø77
1,6 1647	4 CYL ø79 R 18 TRAFIC FUEGO	73 PS / 53 KW 79 PS / 55 KW 66 PS / 50 KW	841 717 A2M 723 841 717 A2M 723 841 717 841 A1MP707	60110002 77 01 460 627	 60110005 77 01 460 708 1,20mm ø80,5
1,7 1721	4 CYL ø81 TRAFIC 06/86-->08/94	68 PS / 50 KW	F1N 720 F1N 722 F1N 724	60107002 Motor Full Takım Gasket Full Set 60107003 77 01 466 406 60107004 77 01 462 817	 60107005 77 00 713 860 1,40mm 60107009 77 00 713 860 1,80mm ø82

▲ : İçerikte Bulunmamaktadır...

▲ : Not included in the set

▲ : Non inclus dans la pochette

00: Motor Takım Keçesiz ve Subap Lastiksiz











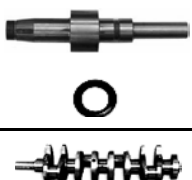
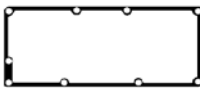





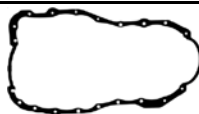



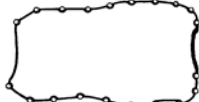

00: Gasket Set Without oil seals Without Valve Stem Seal

01: Motor Takım Keçesiz - Subap Lastikli

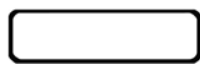
01: Gasket set With Valve Stem Seal Without Oil Seals

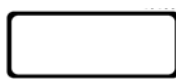
02: Motor Full Takım Keçeli ve Subap Lastikli

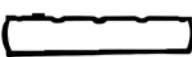
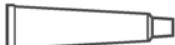
02: Gasket Full Set With oil seals and Valve Stem Seals

Subap Kapak Valve Cover Gasket Zylinderkopfhaube Couvre-culbut.	Karter Oil Pan Ölwanne Carter d'huile	Emme Manifold Intake Manifold Ansaug Admission	Egzoz Manifold Exhaust Manifold Auspuffkrümmer Collecteur D'echappement	Eksoz Boğaz Exhaust Pipe Auspuff Kehle	Supap Keçesi Valve Stem Seal Ventilschaft Queue de soupape	
						
	 62457065 82 00 379 654	 62457219 77 00 105 852  62457418x4 82 00 275 057	 62457221 77 00 107 181  62457222 82 00 365 915		 62457244x16 77 00 103 938 5,5x11x28x16,4	21208071 33x42x6 RD 21204024 28x42x5 RD 21204005 35x47x7 RD 21204009 80x100x8 LD
	 62457165 77 00 273 486	 60108918x4 77 01 471 932	 60108921 8200191371		 60116026x8 77 00 103 872 7x9,8/13.2x10	21208003 30x42x7 RD 21208001 35x47x7 RD 21208012 80x100x8 LD
 6,5mm 60102525 77 01 348 574	 60102267 77 00 564 813	 60103020 77 00 855 962				21208067 35x50x10 RD 21201034 80x100x13 LD
 60110525 77 00 725 186	 60110265 7700710279	 60109020 77 00 635 407				21201010 32x45x8 RD 21201034 80x100x13 LD
 60104525 77 00 719 666	 62427465	 60107021 77 00 725 397			 60107027x8 77 00 737 124 8x10,8x14,2x10	21201002 22x45x7 LD 21201003 25x42x7 RD 21201027 50x68x10 RD 21201038 85x105x8 LD

■ : Delik - Çentik

■ : Hole - Notch

■ : Trou - Entaille

NOT: Katalogdaki Orijinal Kodlar Referans Amacıyla Kullanılmıştır.Lütfen COTECH Kodlarını Kullanınız.
Original codes used for reference only.Please use COTECH codes for orders.

00



Silindir Kapak

Cylinder Head

01



Zylinderkopf

02



Joint de culasse

03



04

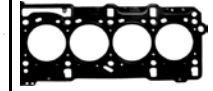

Ltr	MODEL	PS/KW	ENGINE/MOTOR		
1,7	4 CYL ø81				
1721	11 10/83-->	94 PS / 69 KW	F2N 700	60107002	
	19	73 PS / 54 KW	F2N 704	Motor Full Takım	
	21		F2N 708	Gasket Full Set	60107005
	CLIO		F2N 710		77 00 713 860
	SUPER 5		F2N 711	60107003	1,40mm
	5		F2N 712	77 01 466 406	
	9		F2N 716	60107004	60107009
			F2N 720	77 01 462 817	77 00 713 860
			F2N 721		1,80mm
			F2N 722		ø82
			F2N 724		
			F2N 726		
			F2N 727		
			F2N 728		
			F2N 730		
			F2N 732		
			F2N 740		
			F2N 742		
			F2N 750		
			F2N 752		
			F2N 753		
			F2N 754		
			F2N 758		
			F2N 770		
			F2N 783		
			F2N 786		
			F2N 796		
			F2N 797		
			F2N 798		
	11 10/84-->12/95	107 PS / 79 KW	F3N 702		
	19	73 PS / 54 KW	F3N 708		
	21		F3N 716		
	9		F3N 717		
	SUPER 5		F3N 718		
			F3N 722		
			F3N 723		
			F3N 726		
			F3N 740		
			F3N 741		
			F3N 742		
			F3N 743		
			F3N 746		

▲ : İçerikte Bulunmamaktadır...

▲ : Not included in the set

▲ : Non inclus dans la pochette

00: Motor Takım Keçesiz ve Subap Lastiksiz







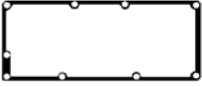
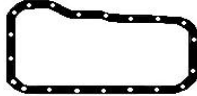

00: Gasket Set Without oil seals Without Valve Stem Seal

01: Motor Takım Keçesiz - Subap Lastikli

01: Gasket set With Valve Stem Seal Without Oil Seals

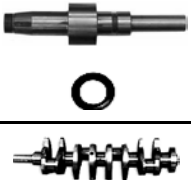
02: Motor Full Takım Keçeli ve Subap Lastikli

02: Gasket Full Set With oil seals and Valve Stem Seals

<p>Subap Kapak Valve Cover Gasket Zylinderkopfhaube Couvre-culbut.</p> 	<p>Karter Oil Pan Ölwanne Carter d'huile</p> 	<p>Emme Manifold Intake Manifold Ansaug Admission</p> 	<p>Egzoz Manifold Exhaust Manifold Auspuffkrümmer Collecteur D'echappement</p> 	<p>Eksoz Boğaz Exhaust Pipe Auspuff Kehle</p> 	<p>Supap Keçesi Valve Stem Seal Ventilschaft Queue de soupape</p> 	
 <p>60104525 77 00 719 666</p>	 <p>62427465</p>	 <p>60107021 77 00 725 397</p>			 <p>60107027x8 77 00 737 124 8x10,8x14,2x10</p>	<p>21201002 22x45x7 LD</p> <p>21201003 25x42x7 RD</p> <p>21201027 50x68x10 RD</p> <p>21201038 85x105x8 LD</p>

■ : Delik - Çentik

■ : Hole - Notch

■ : Trou - Entaille

NOT: Katalogdaki Orijinal Kodlar Referans Amacıyla Kullanılmıştır.Lütfen COTECH Kodlarını Kullanınız.
Original codes used for reference only.Please use COTECH codes for orders.

00



Silindir Kapak
Cylinder Head
Zylinderkopf
Joint de culasse

01



02



03



04

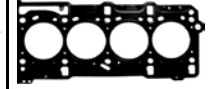

Ltr	MODEL	PS/KW	ENGINE/MOTOR		
1,8 1794	4 CYL ø82,7 CLIO CLIO Rsi LAGUNA 19 08/90-->03/01	110 PS / 81 KW 88 PS / 65 KW	F3P 670 F3P 676 F3P 678 F3P 682 F3P 700 F3P 704 F3P 705 F3P 706 F3P 707 F3P 708 F3P 710 F3P 712 F3P 714 F3P 720 F3P 724 F3P 754 F3P 755 F3P 758 F3P 760 F3P 764 F3P 765	60134002 Motor Full Takım Gasket Full Set 60134003 77 01 467 058 60113004 77 01 462 817	 60134005 77 00 859 273 1,20mm 60134007 77 00 859 273 1,60mm ø83,7
1,8 1794	4 CYL ø82,7 LAGUNA 06/95-->02/01	94 PS / 69 KW	F3P 674	60134003 77 01 467 058 60152104 77 01 470 176	 60134005 77 00 859 273 1,20mm 60134007 77 00 859 273 1,60mm ø83,7
1,8 1783	4 CYL ø82,7 LAGUNA 16V MEGANE Grandtour 16V MEGANE 16V SCÉNIC SCÉNIC 16V LAGUNA 16V 04/98--> 03/01-->	120 PS / 88 KW 115 PS / 85 KW 121 PS / 89 KW 116 PS / 85 KW	F4P 720 F4P 722 F4P 760 F4P 771 F4P 773 F4P 775 F4P 770 F4P 772 F4P 774	62457302 Motor Full Takım Gasket Full Set 62457303 77 01 471 278 62457304 77 01 477 218 77 01 471 360	 62457305 77 00 108 254 MLS ø84

▲ : İçerikte Bulunmamaktadır...

▲ : Not included in the set

▲ : Non inclus dans la pochette

00: Motor Takım Keçesiz ve Subap Lastiksiz











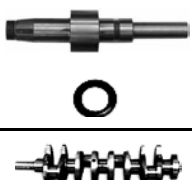
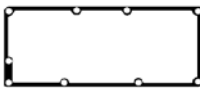





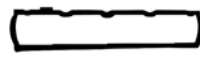

00: Gasket Set Without oil seals Without Valve Stem Seal

01: Motor Takım Keçesiz - Subap Lastikli

01: Gasket set With Valve Stem Seal Without Oil Seals

02: Motor Full Takım Keçeli ve Subap Lastikli

02: Gasket Full Set With oil seals and Valve Stem Seals

Subap Kapak Valve Cover Gasket Zylinderkopfhaube Couvre-culbut.	Karter Oil Pan Ölwanne Carter d'huile	Emme Manifold Intake Manifold Ansaug Admission	Egzoz Manifold Exhaust Manifold Auspuffkrümmer Collecteur D'echappement	Eksoz Boğaz Exhaust Pipe Auspuff Kehle	Supap Keçesi Valve Stem Seal Ventilschaft Queue de soupape	
						
 60104525 77 00 719 666	 60113265 77 00 859 751	 60134021 77 00 854 539			 60107027x8 77 00 737 124 8x10,8x14,2x10	21201002 22x45x7 LD 21201003 25x42x7 RD 21201027 50x68x10 RD 21201038 85x105x8 LD
 60104525 77 00 719 666	 60152065 77 00 114 424	 60134021 77 00 854 539			 60107027x8 77 00 737 124 8x10,8x14,2x10	21201002 22x45x7 LD 21201003 25x42x7 RD 21204014 42x54x6 RD 21208011 85x105x11 LD
	 60152065 77 00 114 424	 62457319 77 00 109 906  62457218x4 82 00 052 312	 62457321 77 00 105 843		 62457244x16 77 00 103 938 5,5x11x2816,4	21208070x2 28x47x5,5 RD 21204014 42x54x6 RD 21208011 85x105x11 LD

■ : Delik - Çentik

■ : Hole - Notch

■ : Trou - Entaille

NOT: Katalogdaki Orijinal Kodlar Referans Amacıyla Kullanılmıştır.Lütfen COTECH Kodlarını Kullanınız.
Original codes used for reference only.Please use COTECH codes for orders.

00



01



02



03











04



Silindir Kapak
Cylinder Head
Zylinderkopf
Joint de culasse



Ltr	MODEL	PS/KW	ENGINE/MOTOR		
1,9 1870	4 CYL ø80 CLIO DTi 03/99--> CLIO DTi ESPACE dCi ESPACE DCi KANGOO DCi KANGOO DTi LAGUNA dCi LAGUNA DCi MASTER DCi MEGANE dCi MEGANE DCi MEGANE DCi MEGANE DTi MEGANE Grandtour DCi MEGANE Grandtour DTi SCÉNIC DCi SCÉNIC DTi TRAFIC dCi TRAFIC DCi TRAFIC 1.9 dCi	120 PS / 88 KW 80 PS / 59 KW	F9Q 650 F9Q 664 F9Q 674 F9Q 680 F9Q 717 F9Q 718 F9Q 732 F9Q 733 F9Q 738 F9Q 740 F9Q 744 F9Q 748 F9Q 750 F9Q 751 F9Q 752 F9Q 754 F9Q 756 F9Q 760 F9Q 762 F9Q 772 F9Q 774 F9Q 780 F9Q 782 F9Q 790 F9Q 800 F9Q 808 F9Q 820 F9Q 826	60152102 Motor Takım Gasket Set  60152103 77 01 470 288  60152104 77 01 470 176	
1,9 1870	4 CYL ø80 LAGUNA DTi 03/97-->08/03 MEGANE DTi MEGANE Scenic DTi SCÉNIC DTi	98 PS / 72 KW	F9Q 716 F9Q 730 F9Q 734 F9Q 722 F9Q 731 F9Q 736	60152102 Motor Takım Gasket Set  60152103 77 01 470 288  60152104 77 01 470 176	 60152105 77 00 859 059 1,45mm 1  60152106 77 00 105 392 1,35mm 2  60152107 77 00 105 393 1,55mm 3  60152104 77 01 470 176 FIBER / FIBRE ø81

▲ : İçerikte Bulunmamaktadır...

▲ : Not included in the set

▲ : Non inclus dans la pochette

00: Motor Takım Keçesiz ve Subap Lastiksiz











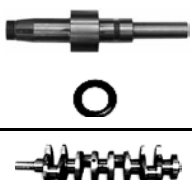
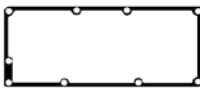



00: Gasket Set Without oil seals Without Valve Stem Seal

01: Motor Takım Keçesiz - Subap Lastikli

01: Gasket set With Valve Stem Seal Without Oil Seals

02: Motor Full Takım Keçeli ve Subap Lastikli

02: Gasket Full Set With oil seals and Valve Stem Seals

Subap Kapak Valve Cover Gasket Zylinderkopfhaube Couvre-culbut.	Karter Oil Pan Ölwanne Carter d'huile	Emme Manifold Intake Manifold Ansaug Admission	Egzoz Manifold Exhaust Manifold Auspuffkrümmer Collecteur D'echappement	Eksoz Boğaz Exhaust Pipe Auspuff Kehle	Supap Keçesi Valve Stem Seal Ventilschaft Queue de soupape	
						
 60152025 82 00 060 882	 60152065 77 00 114 424	 60152121 77 00 874 592			 60116026x8 77 00 736 465 7x9,8/13.2x10	21204002 25x42x8 RD
						21204014 42x54x6 RD
						21208011 85x105x11 LD
 60152025 82 00 060 882	 60152065 77 00 114 424	 60152121 77 00 874 592			 60116026x8 77 00 736 465 7x9,8/13.2x10	21204002 25x42x8 RD
						21204014 42x54x6 RD
						21208011 85x105x11 LD

■ : Delik - Çentik

■ : Hole - Notch

■ : Trou - Entaille

NOT: Katalogdaki Orijinal Kodlar Referans Amacıyla Kullanılmıştır.Lütfen COTECH Kodlarını Kullanınız.
Original codes used for reference only.Please use COTECH codes for orders.

00



01



02



03



04



Silindir Kapak
Cylinder Head
Zylinderkopf
Joint de culasse

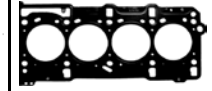

Ltr	MODEL	PS/KW	ENGINE/MOTOR		
1,9 1870	4 CYL ø80 MEGANE DTI 01/96--> MEGANE Scenic DTI TRAFIC D MEGANE D 09/90--> MEGANE DTI MEGANE Scenic DTI MEGANE TDI 19 D 19 DT 19 TD	90 PS / 66 KW 60 PS / 44 KW 94 PS / 69 KW 90 PS / 66 KW	F8Q 600 F8Q 606 F8Q 786 F8Q 610 F8Q 740 F8Q 744 F8Q 768 F8Q 784		
					 60152005 82 00 188 391 1,60mm 3 M 60152006 82 00 188 114 1,50mm 1 M 60152007 82 00 188 390 1,40mm 2 M ø81
1,9 1870	4 CYL ø80 19 D 03/86--> 21 D MEGANE D MEGANE Grandtour D MEGANE Scenic DCI RAPID D CLIO CLIO D	65 PS / 48 KW 54 PS / 40 KW	F8Q 620 F8Q 622 F8Q 640 F8Q 678 F8Q 682 F8Q 706 F8Q 710 F8Q 714 F8Q 722 F8Q 724 F8Q 730 F8Q 732 F8Q 742 F8Q 764 F8Q 774 F8Q 776 F8Q 790	60113102 Motor Full Takım Gasket Full Set 60113002 Motor Takım Gasket Set 60113003 77 01 462 816 60113004 77 01 462 817	 60113005 77 00 745 725 1,85mm 3 M 60113006 77 00 743 369 1,75mm 1 M 60113007 77 00 745 724 1,65mm 2 M ø81
1,9 1870	4 CYL ø80 CLIO D 01/96--> CLIO dCi KANGOO MEGANE D THALIA D	90 PS / 66 KW 54 PS / 40 KW	F8Q 624 F8Q 630 F8Q 632 F8Q 636 F8Q 644 F8Q 648 F8Q 662	60151902 Motor Full Takım Gasket Full Set 60152002 Motor Takım Gasket Set 60113003 77 01 462 816 60152104 77 01 470 176	 60152005 82 00 188 391 1,60mm 3 M 60152006 82 00 188 114 1,50mm 1 M 60152007 82 00 188 390 1,40mm 2 M ø81

▲ : İçerikte Bulunmamaktadır...

▲ : Not included in the set

▲ : Non inclus dans la pochette

00: Motor Takım Keçesiz ve Subap Lastiksiz











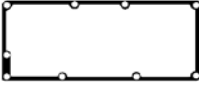

00: Gasket Set Without oil seals Without Valve Stem Seal

01: Motor Takım Keçesiz - Subap Lastikli

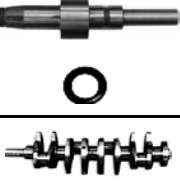
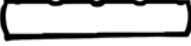
01: Gasket set With Valve Stem Seal Without Oil Seals

02: Motor Full Takım Keçeli ve Subap Lastikli

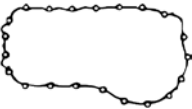
02: Gasket Full Set With oil seals and Valve Stem Seals

<p>Subap Kapak Valve Cover Gasket Zylinderkopfhaube Couvre-culbut.</p> 	<p>Karter Oil Pan Ölwanne Carter d'huile</p> 	<p>Emme Manifold Intake Manifold Ansaug Admission</p> 	<p>Egzoz Manifold Exhaust Manifold Auspuffkrümmer Collecteur D'echappement</p> 	<p>Eksoz Boğaz Exhaust Pipe Auspuff Kehle</p> 	<p>Supap Keçesi Valve Stem Seal Ventilschaft Queue de soupape</p> 	
 <p>60104525 77 00 719 666</p>	 <p>60113265 77 00 859 751</p>	 <p>60113021 77 00 103 849</p>			 <p>60107027x8 77 00 737 124 8x10,8x14,2x10</p>	<p>21204002 25x42x8 RD</p> <p>21201027 50x68x10 RD</p> <p>21201038 85x105x8 LD</p>
 <p>60104525 77 00 719 666</p>	 <p>60152065 77 00 114 424</p>	 <p>60113021 77 00 103 849</p>			 <p>60107027x8 77 00 737 124 8x10,8x14,2x10</p>	<p>21204002 25x42x8 RD</p> <p>21204014 42x54x6 RD</p> <p>21208011 85x105x11 LD</p>

■ : Delik - Çentik

■ : Hole - Notch

■ : Trou - Entaille

NOT: Katalogdaki Orijinal Kodlar Referans Amacıyla Kullanılmıştır.Lütfen COTECH Kodlarını Kullanınız.
Original codes used for reference only.Please use COTECH codes for orders.

00



01



02



03



04



Silindir Kapak
Cylinder Head
Zylinderkopf
Joint de culasse

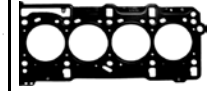

Ltr	MODEL	PS/KW	ENGINE/MOTOR		
2.0 1998	4 CYL ø82,7 ESPACE 06/95--> LAGUNA MEGANE MEGANE Scenic	114 PS / 84 KW 109 PS / 80 KW	F3R 611 F3R 742 F3R 768 F3R 769 F3R 791 F3R 796 F3R 797 F3R 798	60134003 77 01 467 058 60152104 77 01 470 176	 60134005 77 00 859 273 1,20mm 60134007 1,60mm ø83,7
2.0 1998	4 CYL ø82,7 ESPACE 11/93--> LAGUNA MEGANE MEGANE Scenic	114 PS / 84 KW 109 PS / 80 KW	F3R 722 F3R 723 F3R 728 F3R 729 F3R 750 F3R 751 F3R 752	60134002 Motor Full Takım Gasket Full Set 60134003 77 01 467 058 60113004 77 01 462 817	 60134005 77 00 859 273 1,20mm 60134007 1,60mm ø83,7
2.0 1998	4 CYL ø82,7 CLIO 16V 10/98--> ESPACE ESPACE 16V GRAND SCÉNIC LAGUNA LAGUNA 16V MEGANE MEGANE 16V SCÉNIC SCÉNIC 16V THALIA CLIO 16V 03/01--> TRAFIC ESPACE 11/02--> TRAFIC	169 PS / 124 KW 133 PS / 98 KW 179 PS / 132 KW 120 PS / 88 KW 136 PS / 100 KW 117 PS / 86 KW	F4R 700 F4R 701 F4R 712 F4R 713 F4R 714 F4R 715 F4R 730 F4R 732 F4R 736 F4R 738 F4R 740 F4R 741 F4R 744 F4R 746 F4R 747 F4R 770 F4R 771 F4R 780 F4R 790 F4R 791 F4R 720 F4R 722 F4R 738 F4R 792 F4R 820		 62457305 77 00 108 254 MLS ø84

▲ : İçerikte Bulunmamaktadır...

▲ : Not included in the set

▲ : Non inclus dans la pochette

00: Motor Takım Keçesiz ve Subap Lastiksiz











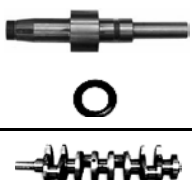
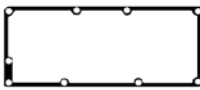





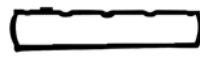

00: Gasket Set Without oil seals Without Valve Stem Seal

01: Motor Takım Keçesiz - Subap Lastikli

01: Gasket set With Valve Stem Seal Without Oil Seals

02: Motor Full Takım Keçeli ve Subap Lastikli

02: Gasket Full Set With oil seals and Valve Stem Seals

Subap Kapak Valve Cover Gasket Zylinderkopfhaube Couvre-culbut.	Karter Oil Pan Ölwanne Carter d'huile	Emme Manifold Intake Manifold Ansaug Admission	Egzoz Manifold Exhaust Manifold Auspuffkrümmer Collecteur D'echappement	Eksoz Boğaz Exhaust Pipe Auspuff Kehle	Supap Keçesi Valve Stem Seal Ventilschaft Queue de soupape	
						
 60104525 77 00 719 666	 60152065 77 00 114 424	 60134021 77 00 854 539			 60107027x8 77 00 737 124 8x10,8x14,2x10	21201002 22x45x7 LD 21201003 25x42x7 RD
 60104525 77 00 719 666	 60113265 77 00 859 751	 60134021 77 00 854 539			 60107027x8 77 00 737 124 8x10,8x14,2x10	21201002 22x45x7 LD 21201003 25x42x7 RD 21204014 42x54x6 RD 21208011 85x105x11 LD
 60104525 77 00 719 666	 60113265 77 00 859 751	 60134021 77 00 854 539			 60107027x8 77 00 737 124 8x10,8x14,2x10	21201002 22x45x7 LD 21201003 25x42x7 RD 21201027 50x68x10 RD 21201038 85x105x8 LD

 : Delik - Çentik

 : Hole - Notch

 : Trou - Entaille

NOT: Katalogdaki Orijinal Kodlar Referans Amacıyla Kullanılmıştır.Lütfen COTECH Kodlarını Kullanınız.
Original codes used for reference only.Please use COTECH codes for orders.

00



Silindir Kapak

Cylinder Head

01



Zylinderkopf

02



Joint de culasse

03



04



Ltr	MODEL	PS/KW	ENGINE/MOTOR		
2.0 1995	4 CYL ø88 03/80-->07/98	120 PS / 88 KW 79 PS / 58 KW	J5R 716 J5R 718 J5R 722 J5R 726 J5R 728 J7R 722 J7R 723 J7R 746 J7R 747 J7R 750 J7R 751 829 720 829 721 829 730 829 731	60112002 77 01 460 132	 60112005 77 00 720 788 ø89
18 20 21 25	10/77-->10/96	118 PS / 87 KW 101 PS / 74 KW	J6R 234 J6R 236 J6R 706 J6R 707 J6R 710 J6R 711 J6R 712 J6R 713 J6R 714 J6R 715 J6R 716 J6R 726 J6R 734 J6R 758 J6R 759 J6R 760 J6R 762 J6R 763 J6R 792 J6R 793 J7R 760 J7R 768 829 700 829 701 829 702 829 703 829 710		
MASTER MASTER D TRAFIC					
TRAFIC 20	03/80-->12/86	103 PS / 76 KW 79 PS / 58 KW	829 702 829 703 829 720 829 721		

▲ : İçerikte Bulunmamaktadır...

▲ : Not included in the set

▲ : Non inclus dans la pochette

00: Motor Takım Keçesiz ve Subap Lastiksiz











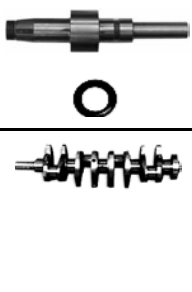
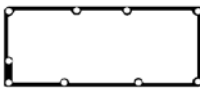

00: Gasket Set Without oil seals Without Valve Stem Seal

01: Motor Takım Keçesiz - Subap Lastikli

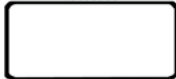
01: Gasket set With Valve Stem Seal Without Oil Seals

02: Motor Full Takım Keçeli ve Subap Lastikli

02: Gasket Full Set With oil seals and Valve Stem Seals

Subap Kapak Valve Cover Gasket Zylinderkopfhaube Couvre-culbut.	Karter Oil Pan Ölwanne Carter d'huile	Emme Manifold Intake Manifold Ansaug Admission	Egzoz Manifold Exhaust Manifold Auspuffkrümmer Collecteur D'echappement	Eksoz Boğaz Exhaust Pipe Auspuff Kehle	Supap Keçesi Valve Stem Seal Ventilschaft Queue de soupape	
						
 60112225 77 00 614 729	 60112265 77 00 591 167	 60112018x4 77 00 728 729  60112019x4 77 00 622 284	 60112120 77 00 622 286	 60112017 77 00 679 861	 60107027x8 77 00 737 124 8x10,8x14,2x10	21201008 30x40x7 RD 21201012 35x47x7 RD
						21201027 50x68x10 RD 21201041 90x110x11

 : Delik - Çentik

 : Hole - Notch

 : Trou - Entaille

NOT: Katalogdaki Orijinal Kodlar Referans Amacıyla Kullanılmıştır.Lütfen COTECH Kodlarını Kullanınız.
Original codes used for reference only.Please use COTECH codes for orders.

00



Silindir Kapak
Cylinder Head
Zylinderkopf
Joint de culasse

01



02



03



04

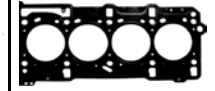

Ltr	MODEL	PS/KW	ENGINE/MOTOR		
2,1 2068	4 CYL ø86 18 D 05/79-->07/98 18 TD 20 D 20 TD 21 21 D 21 TD 25 D 25 TD 30 TD ESPACE TD FUEGO TD MASTER MASTER D TRAFIC D	90 PS / 66 KW 58 PS / 43 KW	J8S J8S 120 J8S 232 J8S 234 J8S 240 J8S 330 J8S 702 J8S 704 J8S 706 J8S 708 J8S 711 J8S 712 J8S 714 J8S 738 J8S 742 J8S 746 J8S 750 J8S 758 J8S 772 J8S 774 J8S 776 J8S 814 J8S 890 852 852 (J8S) 852 J8S 852 710 852 720 852 750 J8S 600 J8S 604 J8S 610 J8S 612 J8S 620 J8S 736 J8S 740 J8S 778 J8S 784 J8S 786 J8S 788 J8S 760	60111002 77 01 461 334	 60111005 77 01 035 218 1,80mm 60111006 77 01 035 217 1,60mm 60111007 77 01 034 507 1,75mm ø87
	ESPACE TD 03/86-->04/98 TRAFIC D 21 D 21 TD 25 D	90 PS / 66 KW 64 PS / 47 KW	J8S 600 J8S 604 J8S 610 J8S 612 J8S 620 J8S 736 J8S 740 J8S 778 J8S 784 J8S 786 J8S 788 J8S 760		
	SAFRANE DT 11/93-->07/96	88 PS / 65 KW	J8S 760		
2,2 2188	4 CYL ø87 ESPACE D 03/96-->03/01 ESPACE TD 12V LAGUNA DTI SAFRANE DT	114 PS / 84 KW 113 PS 63 KW	G8T 714 G8T 716 G8T 740 G8T 760		 60125005 77 00 872 860 1,80mm ø88

▲ : İçerikte Bulunmamaktadır...

▲ : Not included in the set

▲ : Non inclus dans la pochette

00: Motor Takım Keçesiz ve Subap Lastiksiz









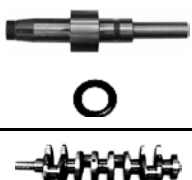
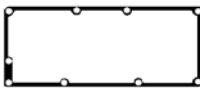

00: Gasket Set Without oil seals Without Valve Stem Seal

01: Motor Takım Keçesiz - Subap Lastikli

01: Gasket set With Valve Stem Seal Without Oil Seals

02: Motor Full Takım Keçeli ve Subap Lastikli

02: Gasket Full Set With oil seals and Valve Stem Seals

Subap Kapak Valve Cover Gasket Zylinderkopfhaube Couvre-culbut.	Karter Oil Pan Ölwanne Carter d'huile	Emme Manifold Intake Manifold Ansaug Admission	Egzoz Manifold Exhaust Manifold Auspuffkrümmer Collecteur D'echappement	Eksoz Boğaz Exhaust Pipe Auspuff Kehle	Supap Keçesi Valve Stem Seal Ventilschaft Queue de soupape	
						
						21201008 30x40x7 RD
60111525 77 00 662 455	60111265 77 00 591 167	60111020 77 00 853 496			60107027x8 77 00 737 124 8x10,8x14,2x10	21201012 35x47x7 RD
						21201027 50x68x10 RD
						21201041 90x110x11

■ : Delik - Çentik

■ : Hole - Notch

■ : Trou - Entaille

NOT: Katalogdaki Orijinal Kodlar Referans Amacıyla Kullanılmıştır.Lütfen COTECH Kodlarını Kullanınız.
Original codes used for reference only.Please use COTECH codes for orders.

00



01



02



03



04



Silindir Kapak
Cylinder Head
Zylinderkopf
Joint de culasse

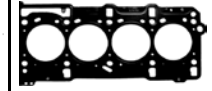

Ltr	MODEL	PS/KW	ENGINE/MOTOR		
2,2 2165	4 CYL ø88 ESPACE MASTER TRAFIC 03/80-->07/98	110 PS / 81 KW 91 PS / 67 KW	J7T 284 J7T 600 J7T 718 J7T 719 J7T 734 J7T 736 J7T 756 J7T 770 J7T 772 J7T 773 J7T 776 J7T 780 J7T 782 J7T 788	60112002 77 01 460 132	 60112005 77 00 720 788 ø89
21 25	04/84-->12/89	124 PS / 91 KW 110 PS / 81 KW	J7T 706 J7T 707 J7T 714 J7T 715 J7T 730 J7T 731 J7T 755		
21 25	06/86-->06/94	110 PS / 81 KW 107 PS / 79 KW	J7T 708 J7T 732 J7T 733 J7T 754 J7T 755		
20	10/80-->12/83	116 PS / 85 KW	851 700		
2,4 2445	4 CYL ø93 MASTER D MASTER D MASTER D 08/93-->02/98 09/86-->12/92 09/86-->10/89	71 PS / 52 KW 72 PS / 53 KW 72 PS / 53 KW	S8U 730 S8U 730 S8U 731		 60147005 77 01 040 180 1,80mm 60147006 77 01 040 179 1,70mm ø95,2
2,5 2499	4 CYL ø93 TRAFIC D MASTER D TRAFIC D MASTER D MASTER D TRAFIC D TRAFIC 05/89-->03/01 03/80-->07/98 03/80-->07/98 07/80-->10/89 03/89-->	69 PS / 51 KW 71 PS / 52 KW 69 PS / 51 KW 75 PS / 55 KW 76 PS / 56 KW 75 PS / 55 KW	S8U 720 S8U 722 S8U 731 S8U 742 S8U 742 S8U 748 S8U 750 S8U 752 S8U 758		 60147005 77 01 040 180 1,80mm 60147006 77 01 040 179 1,70mm ø95,2

▲ : İçerikte Bulunmamaktadır...

▲ : Not included in the set

▲ : Non inclus dans la pochette

00: Motor Takım Keçesiz ve Subap Lastiksiz











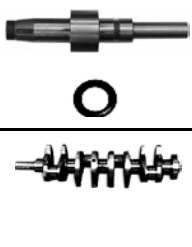
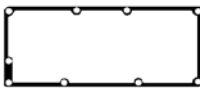

00: Gasket Set Without oil seals Without Valve Stem Seal

01: Motor Takım Keçesiz - Subap Lastikli

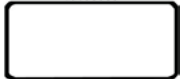
01: Gasket set With Valve Stem Seal Without Oil Seals

02: Motor Full Takım Keçeli ve Subap Lastikli

02: Gasket Full Set With oil seals and Valve Stem Seals

Subap Kapak Valve Cover Gasket Zylinderkopfhaube Couvre-culbut.	Karter Oil Pan Ölwanne Carter d'huile	Emme Manifold Intake Manifold Ansaug Admission	Egzoz Manifold Exhaust Manifold Auspuffkrümmer Collecteur D'echappement	Eksoz Boğaz Exhaust Pipe Auspuff Kehle	Supap Keçesi Valve Stem Seal Ventilschaft Queue de soupape	
						
 60112225 77 00 614 729	 60112265 77 00 591 167	 60112018x4 77 00 728 729	 60112120 77 00 622 286	 60112017 77 00 679 861	 60107027x8 77 00 737 124 8x10,8x14,2x10	21201008 30x40x7 RD 21201012 35x47x7 RD
		 60112019x4 77 00 622 284				21201027 50x68x10 RD 21201041 90x110x11

 : Delik - Çentik

 : Hole - Notch

 : Trou - Entaille

NOT: Katalogdaki Orijinal Kodlar Referans Amacıyla Kullanılmıştır.Lütfen COTECH Kodlarını Kullanınız.
Original codes used for reference only.Please use COTECH codes for orders.

00



01



02



03







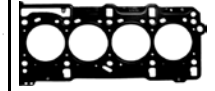

04



Silindir Kapak
Cylinder Head
Zylinderkopf
Joint de culasse



Ltr	MODEL	PS/KW	ENGINE/MOTOR		
2,5 2499	4 CYL ø93 MASTER D 07/98-->01/01	80 PS / 59 KW	S8U 770	60139000 99477116 	 60147005 77 01 040 180 1,80mm 60147006 77 01 040 179 1,70mm ø95,2
2,5 2499	4 CYL ø93 TRAFIC D 05/98--> MASTER D 08/80-->07/98 TRAFIC D 03/80-->03/01 MASTER D 05/89-->03/01 TRAFIC D	75 PS / 55 KW 71 PS / 52 KW 69 PS / 51 KW 75 PS / 55 KW	S8U 780 S8U 782 8140.61.2300 8140.61.240 8140.67.2500 8140.67.2510 8140.67.2550 8140.67.2580		 60147005 77 01 040 180 1,80mm 60147006 77 01 040 179 1,70mm ø95,2
2,5 2499	4 CYL ø93 MASTER TD MASTER DT 08/89-->07/98	94 PS / 69 KW 98 PS / 72 KW 116 PS / 85 KW 95 PS / 70 KW	S9U 700 S9U 704 8140.07 8140.27 8140.47 SU9 702 8140.27.2580 S9U 714 S9U 740 8140.27.2500 8140.27.2510		 60138005 77 01 043 277 1,50mm 60138006 77 01 043 276 1,40mm ø95
2,7 2664	6 CYL ø88 25 V6 04/84-->08/89 30 02/75-->01/84 30 TS 10/78-->12/83 30 TX	141 PS / 104 KW 131 PS / 96 KW 125 PS / 92 KW 143 PS / 105 KW	Z7V 708 Z7V 709 Z7V 711 112 144 140		 79 10 245 291 1,20mm  79 10 245 585 1,20mm ø90 60115005

▲ : İçerikte Bulunmamaktadır...

▲ : Not included in the set

▲ : Non inclus dans la pochette

00: Motor Takım Keçesiz ve Subap Lastiksiz











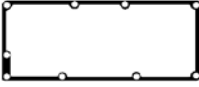

00: Gasket Set Without oil seals Without Valve Stem Seal

01: Motor Takım Keçesiz - Subap Lastikli

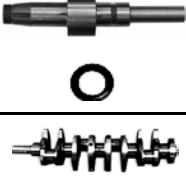
01: Gasket set With Valve Stem Seal Without Oil Seals

02: Motor Full Takım Keçeli ve Subap Lastikli

02: Gasket Full Set With oil seals and Valve Stem Seals

<p>Subap Kapak Valve Cover Gasket Zylinderkopfhaube Couvre-culbut.</p> 	<p>Karter Oil Pan Ölwanne Carter d'huile</p> 	<p>Emme Manifold Intake Manifold Ansaug Admission</p> 	<p>Egzoz Manifold Exhaust Manifold Auspuffkrümmer Collecteur D'echappement</p> 	<p>Eksoz Boğaz Exhaust Pipe Auspuff Kehle</p> 	<p>Supap Keçesi Valve Stem Seal Ventilschaft Queue de soupape</p> 	
 <p>60138045 50 01 846 751</p>  <p>60138047 0249.C3</p>	 <p>60146066 77 01 043 496</p>  <p>60138068 500327440</p>	 <p>60146019x4 77 00 034 967</p>	 <p>60147021x4 77 01 05 824</p>			

■ : Delik - Çentik

■ : Hole - Notch

■ : Trou - Entaille

NOT: Katalogdaki Orijinal Kodlar Referans Amacıyla Kullanılmıştır.Lütfen COTECH Kodlarını Kullanınız.
Original codes used for reference only.Please use COTECH codes for orders.

00



Silindir Kapak

Cylinder Head

01



Zylinderkopf

02



Joint de culasse

03



04

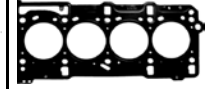

Ltr MODEL PS/KW ENGINE/MOTOR

2,8 4 CYL ø94,4

2799 MASTER DTI

07/98-->

114 PS / 84 KW

S9W 700

S9W 702

60139100

71713696



60139005

77 01 044 227

1,50mm

60139006

77 01 044 226

1,40mm

60139007

77 01 044 225

1,30mm

ø96

▲ : İçerikte Bulunmamaktadır...

▲ : Not included in the set

▲ : Non inclus dans la pochette

00: Motor Takım Keçesiz ve Subap Lastiksiz









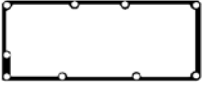
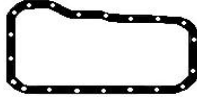

00: Gasket Set Without oil seals Without Valve Stem Seal

01: Motor Takım Keçesiz - Subap Lastikli

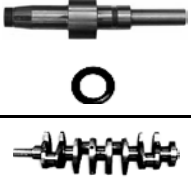
01: Gasket set With Valve Stem Seal Without Oil Seals

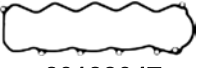
02: Motor Full Takım Keçeli ve Subap Lastikli

02: Gasket Full Set With oil seals and Valve Stem Seals

<p>Subap Kapak Valve Cover Gasket Zylinderkopfhaube Couvre-culbut.</p> 	<p>Karter Oil Pan Ölwanne Carter d'huile</p> 	<p>Emme Manifold Intake Manifold Ansaug Admission</p> 	<p>Egzoz Manifold Exhaust Manifold Auspuffkrümmer Collecteur D'echappement</p> 	<p>Eksoz Boğaz Exhaust Pipe Auspuff Kehle</p> 	<p>Supap Keçesi Valve Stem Seal Ventilschaft Queue de soupape</p> 	
 <p>60138045 50 01 846 751</p>  <p>60138047 0249.C3</p>	 <p>60138068 500327440</p>	 <p>60146019x4 77 00 034 967</p>	 <p>60147021x4 77 01 035 824</p>			

■ : Delik - Çentik

■ : Hole - Notch

■ : Trou - Entaille

NOT: Katalogdaki Orijinal Kodlar Referans Amacıyla Kullanılmıştır.Lütfen COTECH Kodlarını Kullanınız.
Original codes used for reference only.Please use COTECH codes for orders.

00



Silindir Kapak

Cylinder Head

01



Zylinderkopf

02



Joint de culasse

03



04

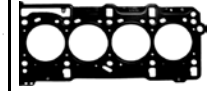

Ltr	MODEL	PS/KW	ENGINE/MOTOR		
2,2 2140	4 CYL 88x88 ESSENCE 671				<p>60135005 855783800 1,30mm ø88</p>
2,6 2600	4 CYL ø93 / 96 ESSENCE 817				<p>60145005 5000131017 1,30mm ø96</p>
3,0 3,3 3,6 3017 3319 3595	4 CYL 98 / 102 TRAFIC SG-2M TRAFIC SG-4 TRAFIC SG-5 TRAFIC SG-5SD TRAFIC SG-5C	70 PS / 51 KW 73 PS / 54 KW	599 599 712	60150001 996090400	<p>60150005 5000044437 1,40mm ø110</p>
3,6 3595	4 CYL ø102 TRAFIC SG-5C T.D	90 PS / 66 KW		60151101 500336300	<p>60150006 5000044908 2,00mm ø110</p>

▲ : İçerikte Bulunmamaktadır...

▲ : Not included in the set

▲ : Non inclus dans la pochette

00: Motor Takım Keçesiz ve Subap Lastiksiz











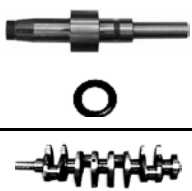
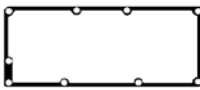





00: Gasket Set Without oil seals Without Valve Stem Seal

01: Motor Takım Keçesiz - Subap Lastikli

01: Gasket set With Valve Stem Seal Without Oil Seals

02: Motor Full Takım Keçeli ve Subap Lastikli

02: Gasket Full Set With oil seals and Valve Stem Seals

Subap Kapak Valve Cover Gasket Zylinderkopfhaube Couvre-culbut.	Karter Oil Pan Ölwanne Carter d'huile	Emme Manifold Intake Manifold Ansaug Admission	Egzoz Manifold Exhaust Manifold Auspuffkrümmer Collecteur D'echappement	Eksoz Boğaz Exhaust Pipe Auspuff Kehle	Supap Keçesi Valve Stem Seal Ventilschaft Queue de soupape	
						
						
60117034 5000041255	60117013 428297200	60117018x4 5000049389	60117020x4 607859100		60139044x8 7301732 8x12x15,2x9,5	
						
60117034 5000041255	60117013 428297200	60117018x4 5000049389	60117020x4 607859100		60139044x8 7301732 8x12x15,2x9,5	

 : Delik - Çentik

 : Hole - Notch

 : Trou - Entaille

NOT: Katalogdaki Orijinal Kodlar Referans Amacıyla Kullanılmıştır.Lütfen COTECH Kodlarını Kullanınız.
Original codes used for reference only.Please use COTECH codes for orders.

00



01



02



03



04



Silindir Kapak
Cylinder Head
Zylinderkopf
Joint de culasse

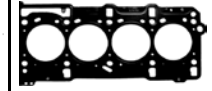

Ltr	MODEL	PS/KW	ENGINE/MOTOR		
1,2 1198	3 CYL ø76,5 FABIA 01/03--> ROOMSTER	70 PS / 51 KW 60 PS / 44 KW	AZQ BME BZG CEVA CGPA CGPB CHTA		 61502005 03E 103 383 F 1,20mm FIBER / FIBRE ø77,5
1,3 1289	4 CYL ø75,5 FAVORIT 115 09/84-->09/94 FAVORIT 136 FELICIA 135 FELICIA 136 FORMAN 136 FAVORIT 135 FORMAN 135 RAPID 130 PICK-UP 781 FAVORIT 781	61 PS / 45 KW 58 PS / 43 KW	135/8 136 L 135 B 136 B AMG AMH OHC	61501001 Motor Takım Gasket Set 61501003 Üst Takım Gasket Head Set	 61501005 114-092854 1,60mm 61501006 114-092854 2,00mm ø77
1,4 1391	4 CYL ø76,5 FABIA 10/99--> OCTAVIA OCTAVIA 08/00--> FABIA 06/04--> OCTAVIA ROOMSTER	100 PS / 74 KW 75 PS / 55 KW 75 PS / 55 KW 86 PS / 63 KW 80 PS / 59 KW	AUA AUB AXP BBY BBZ BKY BCA BUD BXW CGGA	61405303	 61405305 036 103 383 AM MLS ø77,5
1,9 1896	4 CYL ø79,5 FELICIA 10/95-->06/01	64 PS / 47 KW	AEY		 61405205 028 103 383 BN 1,61mm 3 ■ 61405206 028 103 383 BM 1,53mm 2 ■ 61405207 028 103 383 BL 1,45mm 1 ■ MLS ø81

▲ : İçerikte Bulunmamaktadır...

▲ : Not included in the set

▲ : Non inclus dans la pochette

00: Motor Takım Keçesiz ve Subap Lastiksiz











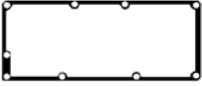
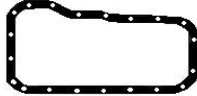

00: Gasket Set Without oil seals Without Valve Stem Seal

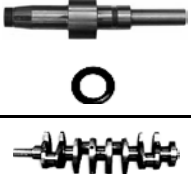
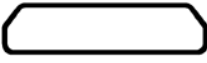
01: Motor Takım Keçesiz - Subap Lastikli

01: Gasket set With Valve Stem Seal Without Oil Seals

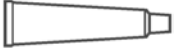
02: Motor Full Takım Keçeli ve Subap Lastikli

02: Gasket Full Set With oil seals and Valve Stem Seals

<p>Subap Kapak Valve Cover Gasket Zylinderkopfhaube Couvre-culbut.</p> 	<p>Karter Oil Pan Ölwanne Carter d'huile</p> 	<p>Emme Manifold Intake Manifold Ansaug Admission</p> 	<p>Egzoz Manifold Exhaust Manifold Auspuffkrümmer Collecteur D'echappement</p> 	<p>Eksoz Boğaz Exhaust Pipe Auspuff Kehle</p> 	<p>Supap Keçesi Valve Stem Seal Ventilschaft Queue de soupape</p> 	
 <p>61501025 047 103 483</p>	 <p>61501013 113-090920</p>	 <p>61501020 114-095840</p>	 <p>61501017 115690840</p>	 <p>60107027x8 113-028540 8x10,8x14,2x10</p>		
 <p>62427465</p>	 <p>62427465</p>	 <p>61405319x6 036 129 717 E</p>	 <p>61405321 036 253 039 F</p>	 <p>62457127x16 036 109 675 6x8,8x12,2x9,7</p>	<p>21204029x2 27x42x8 RD</p>	

■ : Delik - Çentik

■ : Hole - Notch

■ : Trou - Entaille

NOT: Katalogdaki Orijinal Kodlar Referans Amacıyla Kullanılmıştır.Lütfen COTECH Kodlarını Kullanınız.
Original codes used for reference only.Please use COTECH codes for orders.

00



Silindir Kapak
Cylinder Head

01



Zylinderkopf

02



Joint de culasse

03



04



Ltr	MODEL	PS/KW	ENGINE/MOTOR	
1,6 1588	4 CYL ø80,5 CORONA 02/77-->03/83 HI-LUX HI-ACE TOYO-ACE	67 PS / 49 KW	12R 12R-U/RJ	<p>61411505 11115-31020 1,80mm</p> <p>61411506 11115-31020 2,0mm ø83</p>
1,8 1812	4 CYL ø86 TOWN-ACE 03/83-->11/89 LITE-ACE HI-LUX CORONA DYNA 100 MASTER-ACE	79 PS / 58 KW 83 PS / 61 KW	1Y-J 2Y 2YPU	<p>61411605 11115-71010 1,80mm</p> <p>61411606 11115-71010 2,0mm ø88</p>
2,0 1998	4 CYL ø86 HI-ACE 01/84-->11/89 HI-LUX CROWN CRESSIDA WAGON DYNA 150	88 PS / 65 KW 78 PS / 57 KW	3Y 3Y-PU	<p>61411605 11115-71010 1,80mm</p> <p>61411606 11115-71010 2,0mm ø88</p>
2,0 1998	4 CYL ø86 HI-LUX 16V 04/06-->09/06 INNOVA 16V	133 PS / 98 KW	1TR-FE	<p>61411805 11115-0C011 1,20mm FIBER / FIBRE</p> <p>61411806 11115-0C011 2,00mm FIBER / FIBRE ø88</p>

▲ : İçerikte Bulunmamaktadır...

▲ : Not included in the set

▲ : Non inclus dans la pochette

00: Motor Takım Keçesiz ve Subap Lastiksiz







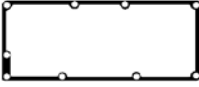

00: Gasket Set Without oil seals Without Valve Stem Seal

01: Motor Takım Keçesiz - Subap Lastikli

01: Gasket set With Valve Stem Seal Without Oil Seals

02: Motor Full Takım Keçeli ve Subap Lastikli

02: Gasket Full Set With oil seals and Valve Stem Seals

<p>Subap Kapak Valve Cover Gasket Zylinderkopfhaube Couvre-culbut.</p> 	<p>Karter Oil Pan Ölwanne Carter d'huile</p> 	<p>Emme Manifold Intake Manifold Ansaug Admission</p> 	<p>Egzoz Manifold Exhaust Manifold Auspuffkrümmer Collecteur D'echappement</p> 	<p>Eksoz Boğaz Exhaust Pipe Auspuff Kehle</p> 	<p>Supap Keçesi Valve Stem Seal Ventilschaft Queue de soupape</p> 	  

■ : Delik - Çentik

■ : Hole - Notch

■ : Trou - Entaille

NOT: Katalogdaki Orijinal Kodlar Referans Amacıyla Kullanılmıştır.Lütfen Cotech Kodlarını Kullanınız.
Original codes used for reference only.Please use Cotech codes for orders.

00



Silindir Kapak

Cylinder Head

01



Zylinderkopf

02



Joint de culasse

03



04

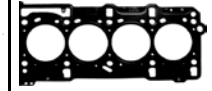

Ltr	MODEL	PS/KW	ENGINE/MOTOR	
2,2 2237	4 CYL ø91 TOWN-ACE VAN WAGON STOUT VAN HI-LUX LITE-ACE DYNA 200	01/87-->01/95 98 PS / 72 KW 94 PS / 69 KW	4Y 4Y-EC	<p>61411105 11115-73010 1,60mm</p> <p>61411106 11115-73010 2,00mm ø93</p>
2,7 2694	4 CYL ø95 HI-LUX 16V INNOVA 16V FORTURNER 16V TACOMA 16V HI-ACE 16V	08/04--> 144 PS / 106 KW 151 PS / 111 KW		<p>61411705 11115-0C020 1,20mm FIBER / FIBRE</p> <p>61411706 11115-0C020 2,00mm FIBER / FIBRE</p> <p>ø97</p>

▲ : İçerikte Bulunmamaktadır...

▲ : Not included in the set

▲ : Non inclus dans la pochette

00: Motor Takım Keçesiz ve Subap Lastiksiz







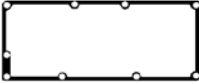

00: Gasket Set Without oil seals Without Valve Stem Seal

01: Motor Takım Keçesiz - Subap Lastikli

01: Gasket set With Valve Stem Seal Without Oil Seals

02: Motor Full Takım Keçeli ve Subap Lastikli

02: Gasket Full Set With oil seals and Valve Stem Seals

<p>Subap Kapak Valve Cover Gasket Zylinderkopfhaube Couvre-culbut.</p> 	<p>Karter Oil Pan Ölwanne Carter d'huile</p> 	<p>Emme Manifold Intake Manifold Ansaug Admission</p> 	<p>Egzoz Manifold Exhaust Manifold Auspuffkrümmer Collecteur D'echappement</p> 	<p>Eksoz Boğaz Exhaust Pipe Auspuff Kehle</p> 	<p>Supap Keçesi Valve Stem Seal Ventilschaft Queue de soupape</p> 	  

■ : Delik - Çentik

■ : Hole - Notch

■ : Trou - Entaille

NOT: Katalogdaki Orijinal Kodlar Referans Amacıyla Kullanılmıştır.Lütfen COTECH Kodlarını Kullanınız.
Original codes used for reference only.Please use COTECH codes for orders.

00



Silindir Kapak
Cylinder Head
Zylinderkopf
Joint de culasse

01



02



03



04



Ltr	MODEL	PS/KW	ENGINE/MOTOR		
1,3 1286	4 CYL ø73 66 08/75-->11/79 -->26917	57 PS / 42 KW	B130S B130	▲ 60101001 Motor Takım Gasket Set 60101002 77 01 452 153	 60101005 77 00 576 242 1,20mm 60101009 77 00 576 242 1,80mm ø74,3
1,4 1397	4 CYL ø76 340 343 345 360 08/1975->12/1988	70 PS / 51 KW 63 PS / 46 KW	B 14.3 E B 14.3 S	60102002 3267492-1 ▲ 60102001 3267492-1 60102003 3 267 492-1	 60102005 77 00 680 689 1,20mm 60102006 77 00 680 689 1,40mm 60102009 77 00 680 689 1,80mm ø77
1,6 1596	4 CYL ø79 S40 16V C30 16V 01/05-->	101 PS / 74 KW	B4164S3		 62218205 30 711 613 1,20mm FIBER / FIBRE ø80

▲ : İçerikte Bulunmamaktadır...

▲ : Not included in the set

▲ : Non inclus dans la pochette

00: Motor Takım Keçesiz ve Subap Lastiksiz











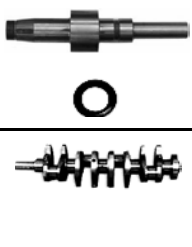
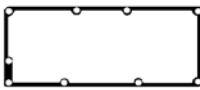

00: Gasket Set Without oil seals Without Valve Stem Seal

01: Motor Takım Keçesiz - Subap Lastikli

01: Gasket set With Valve Stem Seal Without Oil Seals

02: Motor Full Takım Keçeli ve Subap Lastikli

02: Gasket Full Set With oil seals and Valve Stem Seals

Subap Kapak Valve Cover Gasket Zylinderkopfhaube Couvre-culbut.	Karter Oil Pan Ölwanne Carter d'huile	Emme Manifold Intake Manifold Ansaug Admission	Egzoz Manifold Exhaust Manifold Auspuffkrümmer Collecteur D'echappement	Eksoz Boğaz Exhaust Pipe Auspuff Kehle	Supap Keçesi Valve Stem Seal Ventilschaft Queue de soupape	
 5,00mm 60101525 77 00 723 967	 60101265 77 01 453 950	 60101020 77 00 559 702	 60101017 77 00 502 706	 60101017 77 00 502 706	 ▲	 21201011 35x50x8 RD  21201031 70x90x10 LD
 6,5mm 60102525 77 01 348 574	 60102265 77 01 457 561	 60101020 77 00 559 702	 60101017 77 00 502 706	 60101017 77 00 502 706		▲ 21201011 35x50x8 RD ▲ 21201034 80x100x13 LD

■ : Delik - Çentik

■ : Hole - Notch

■ : Trou - Entaille

NOT: Katalogdaki Orijinal Kodlar Referans Amacıyla Kullanılmıştır.Lütfen COTECH Kodlarını Kullanınız.
Original codes used for reference only.Please use COTECH codes for orders.

00



01



02



03









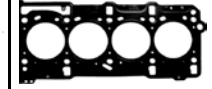

04



Silindir Kapak
Cylinder Head
Zylinderkopf
Joint de culasse



Ltr	MODEL	PS/KW	ENGINE/MOTOR		
1,6 1598	4 CYL ø75 C30 D S40 D S80 II D V50 D V70 III D	01/05--> 110 PS / 81 KW 109 PS / 80 KW	D 4164 T	61707002 Motor Full Takım Gasket Full Set 	 61707005 30 735 085 1,45mm 5  61707006 30 735 084 1,40mm 4  61707007 30 735 082 1,30mm 3  61707008 30 735 081 1,25mm 2  61707009 30 735 083 1,35mm 1  MLS ø76
1,7 1721	4 CYL ø81 340-360 440 T 460 T 480 T 440 460 480	08/85--> 122 PS / 90 KW 79 PS / 58 KW 04/86--> 109 PS / 80 KW 79 PS / 58 KW	B 17 2 K B 18 FT B 18 FTM B 18 K B 18 E B 18 ED B 18 EP B 18 F B 18 FP B 18 KD B 18 KP B 18 KPD		 60107005 3 344 303-7 1,40mm 60107009 3 344 303-7 1,80mm ø82
1,8 1794	4 CYL ø82,2 440 460	08/91-->12/96 90 PS / 66 KW	B 18 U		 60134005 3 467 605 1,20mm 60134007 3 467 605 1,60mm ø83,7

▲ : İçerikte Bulunmamaktadır...

▲ : Not included in the set

▲ : Non inclus dans la pochette

00: Motor Takım Keçesiz ve Subap Lastiksiz











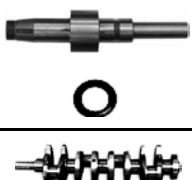
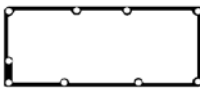



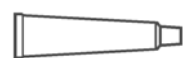

00: Gasket Set Without oil seals Without Valve Stem Seal

01: Motor Takım Keçesiz - Subap Lastikli

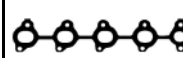
01: Gasket set With Valve Stem Seal Without Oil Seals

02: Motor Full Takım Keçeli ve Subap Lastikli

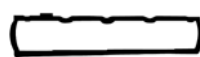
02: Gasket Full Set With oil seals and Valve Stem Seals

Subap Kapak Valve Cover Gasket Zylinderkopfhaube Couvre-culbut.	Karter Oil Pan Ölwanne Carter d'huile	Emme Manifold Intake Manifold Ansaug Admission	Egzoz Manifold Exhaust Manifold Auspuffkrümmer Collecteur D'echappement	Eksoz Boğaz Exhaust Pipe Auspuff Kehle	Supap Keçesi Valve Stem Seal Ventilschaft Queue de soupape	
						
 61707025 30 735 093	 62427465	 30 711 091 x4  30 711 090 x4 61707018 0348.R5+0348.R4 SET	 61706021 30 711 093		 61707026x16 30 711 502 5,5x9,5x18,1x14	21204017 27x47x7 RD 21204018 40x55x6,4 LD 21204019 85x105x8,8 RD
 60104525 77 00 719 666		 60107021 77 00 725 397				
 60104525 77 00 719 666	 60113265 77 00 859 751	 60134021 77 00 854 539				

 : Delik - Çentik

 : Hole - Notch

 : Trou - Entaille

NOT: Katalogdaki Orijinal Kodlar Referans Amacıyla Kullanılmıştır.Lütfen COTECH Kodlarını Kullanınız.
Original codes used for reference only.Please use COTECH codes for orders.

00



01



02



03



04



Silindir Kapak
Cylinder Head
Zylinderkopf
Joint de culasse

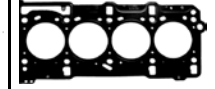

Ltr	MODEL	PS/KW	ENGINE/MOTOR		
1,9 1870	4 CYL ø80 S40 TD 07/94--> V40 TD 440 TD 460 TD	94 PS / 69 KW 90 PS / 66 KW	D 19 T D 4192 T F8Q 768		<p>60152005 3 345 350 1,60mm 3 M</p> <p>60152006 3 345 349 1,50mm 1 M</p> <p>60152007 3 345 348 1,40mm 2 M</p> <p>ø81</p>
1,9 1870	4 CYL ø80 S40 DI 03/99-->07/00 V40 DI	95 PS / 70 KW	D 4192 T2	<p>60152102 Motor Takım Gasket Set</p> <p>60152103 77 01 470 288</p> <p>60152104 77 01 470 176</p>	<p>60152105 30 889 391 1,45mm 1 M</p> <p>60152106 30 889 390 1,35mm 2 M</p> <p>60152107 30 889 392 1,55mm 3 M</p> <p>FIBER / FIBRE ø81</p>
1,9 1870	4 CYL ø80 S40 DI 07/00-->06/04 V40 DI	115 PS / 85 KW 102 PS / 75 KW	D 4192 T3 D 4192 T4	<p>60152102 Motor Takım Gasket Set</p> <p>60152103 77 01 470 288</p> <p>60152104 77 01 470 176</p>	

▲ : İçerikte Bulunmamaktadır...

▲ : Not included in the set

▲ : Non inclus dans la pochette

00: Motor Takım Keçesiz ve Subap Lastiksiz











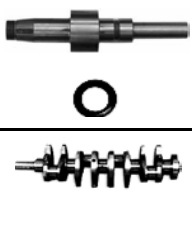
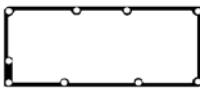



00: Gasket Set Without oil seals Without Valve Stem Seal

01: Motor Takım Keçesiz - Subap Lastikli

01: Gasket set With Valve Stem Seal Without Oil Seals

02: Motor Full Takım Keçeli ve Subap Lastikli

02: Gasket Full Set With oil seals and Valve Stem Seals

Subap Kapak Valve Cover Gasket Zylinderkopfhaube Couvre-culbut.	Karter Oil Pan Ölwanne Carter d'huile	Emme Manifold Intake Manifold Ansaug Admission	Egzoz Manifold Exhaust Manifold Auspuffkrümmer Collecteur D'echappement	Eksoz Boğaz Exhaust Pipe Auspuff Kehle	Supap Keçesi Valve Stem Seal Ventilschaft Queue de soupape	
						
						21204002 25x42x8 RD
60152025 30 621 277	60152065 31 251 147	60152121 30 750 740			60116026x8 3 517 893 7x9,8/13.2x10	21204014 42x54x6 RD
						21208011 85x105x11 LD
						21204002 25x42x8 RD
60152025 30 621 277	60152065 31 251 147	60152121 30 750 740			60116026x8 3 517 893 7x9,8/13.2x10	21204014 42x54x6 RD
						21208011 85x105x11 LD

■ : Delik - Çentik

■ : Hole - Notch

■ : Trou - Entaille

NOT: Katalogdaki Orijinal Kodlar Referans Amacıyla Kullanılmıştır.Lütfen COTECH Kodlarını Kullanınız.
Original codes used for reference only.Please use COTECH codes for orders.

00



Silindir Kapak

Cylinder Head

01



Zylinderkopf

02



Joint de culasse

03



04

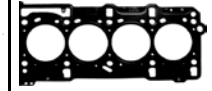

Ltr	MODEL	PS/KW	ENGINE/MOTOR		
2,0 1986	4 CYL ø89 240 340-360 740 740 T 940 940 T 240 340 360 740	08/83-->10/98 08/80-->08/90	189 PS / 139 KW 109 PS / 80 KW 105 PS/ 77 KW 95 PS / 70 KW	B 200 E B 200 EA B 200 ET B 200 F B 200 FT B 200 G B 200 GT B 200 K B 200 K B 200 K B 200 K	 61405005 1 378 645-1 1,30mm ø95
2,0 1998	4 CYL ø82,2 440 460 480	08/92-->07/96	110 PS / 81 KW 109 PS / 80 KW	B 20 F	 60134005 3 467 605 1,20mm 60134007 3 467 605 1,60mm ø83,7
2,0 1999	4 CYL ø87,5 C30 S40 S40 II S80 II V50 V70	10/06-->	146 PS / 107 KW 145 PS / 107 KW	B 4204 S3 B 4204 S4	 61420405 30777325 1,20mm FIBER / FIBRE ø89

▲ : İçerikte Bulunmamaktadır...

▲ : Not included in the set

▲ : Non inclus dans la pochette

00: Motor Takım Keçesiz ve Subap Lastiksiz









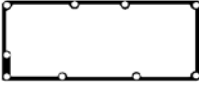

00: Gasket Set Without oil seals Without Valve Stem Seal

01: Motor Takım Keçesiz - Subap Lastikli

01: Gasket set With Valve Stem Seal Without Oil Seals

02: Motor Full Takım Keçeli ve Subap Lastikli

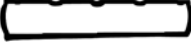
02: Gasket Full Set With oil seals and Valve Stem Seals

<p>Subap Kapak Valve Cover Gasket Zylinderkopfhaube Couvre-culbut.</p> 	<p>Karter Oil Pan Ölwanne Carter d'huile</p> 	<p>Emme Manifold Intake Manifold Ansaug Admission</p> 	<p>Egzoz Manifold Exhaust Manifold Auspuffkrümmer Collecteur D'echappement</p> 	<p>Eksoz Boğaz Exhaust Pipe Auspuff Kehle</p> 	<p>Supap Keçesi Valve Stem Seal Ventilschaft Queue de soupape</p> 	  
 <p>60104525 77 00 719 666</p>	 <p>60113265 77 00 859 751</p>	 <p>60134021 77 00 854 539</p>				

■ : Delik - Çentik

■ : Hole - Notch

■ : Trou - Entaille

NOT: Katalogdaki Orijinal Kodlar Referans Amacıyla Kullanılmıştır.Lütfen COTECH Kodlarını Kullanınız.
Original codes used for reference only.Please use COTECH codes for orders.

00



Silindir Kapak
Cylinder Head
Zylinderkopf
Joint de culasse

01



02



03



04



Ltr	MODEL	PS/KW	ENGINE/MOTOR		
2,0	4 CYL ø89				
1986	240 1977-->	117 PS / 86 KW	B19E	61405000	
	242 1977-->	117 PS / 86 KW	B19E	270676-0	61405005 1 378 645-1 1,30mm ø95
	244 1977-->	117 PS / 86 KW	B19E	270677-8	
	245 1977-->	117 PS / 86 KW	B19E		
	340 08/1982-->07/1984	115 PS / 85 KW	B19E		
	343 08/1982-->07/1984	115 PS / 85 KW	B19E		
	344 08/1982-->07/1984	115 PS / 85 KW	B19E		
	345 08/1982-->07/1984	115 PS / 85 KW	B19E		
	360 1983-->	117 PS / 86 KW	B19E		
	740 1983-->	117 PS / 86 KW	B19E		
	760 1983-->	117 PS / 86 KW	B19E		
	240 1977-->	90 PS / 66 KW	B19A		
	242 1977-->	90 PS / 66 KW	B19A		
	244 1977-->	90 PS / 66 KW	B19A		
	245 1977-->	90 PS / 66 KW	B19A		
	340 08/1983->07/1984	92 PS / 68 KW	B19A		
	343 1977-->	90 PS / 66 KW	B19A		
	344 08/1983->07/1984	92 PS / 68 KW	B19A		
	345 1977-->	90 PS / 66 KW	B19A		
	GLE GLS DLS				
2,1	4 CYL ø92				
2127	240 08/1975->07/1984	107 PS / 79 KW	B21 A	61405000	
	240 08/1980->07/1985	155 PS / 114 KW	B21 ET	270676-0	61405005 1 378 645-1 1,30mm ø95
	240 08/1980->07/1984	107 PS / 79 KW	B21F	270677-8	
	242 08/1980->07/1985	155 PS / 114 KW	B21 ET		
	242 08/1975->07/1984	107 PS / 79 KW	B21 A		
	242 1975--->	136 PS / 100 KW	B21E/F/T		
	242 1975--->	136 PS / 100 KW	B21E/F/T		
	244 1975--->	136 PS / 100 KW	B21E/F/T		
	244 08/1975->07/1984	107 PS / 79 KW	B21 A		
	244 08/1980->07/1985	155 PS / 114 KW	B21 ET		
	245 08/1975->07/1984	107 PS / 79 KW	B21 A		
	245 1975--->	136 PS / 100 KW	B21E/F/T		
	440 08/1993-->09/1995	110 PS / 80 KW	B21E		
	445 08/1993-->09/1995	110 PS / 80 KW	B21E		
	460 08/1993-->09/1995	110 PS / 80 KW	B21E		
	464 08/1993-->09/1995	110 PS / 80 KW	B21E		
	740 1975--->	136 PS / 100 KW	B21E/F/T		
	760 1975--->	136 PS / 100 KW	B21E/F/T		
	GLE				
	240 08/1974-->07/1984	97 PS / 71 KW 107 PS / 79 KW	B21 A		

▲ : İçerikte Bulunmamaktadır...

▲ : Not included in the set

▲ : Non inclus dans la pochette

00: Motor Takım Keçesiz ve Subap Lastiksiz











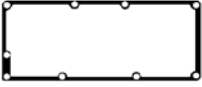
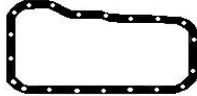



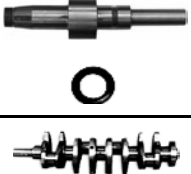
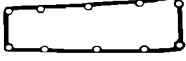

00: Gasket Set Without oil seals Without Valve Stem Seal

01: Motor Takım Keçesiz - Subap Lastikli

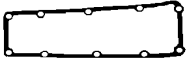
01: Gasket set With Valve Stem Seal Without Oil Seals

02: Motor Full Takım Keçeli ve Subap Lastikli

02: Gasket Full Set With oil seals and Valve Stem Seals

<p>Subap Kapak Valve Cover Gasket Zylinderkopfhaube Couvre-culbut.</p> 	<p>Karter Oil Pan Ölwanne Carter d'huile</p> 	<p>Emme Manifold Intake Manifold Ansaug Admission</p> 	<p>Egzoz Manifold Exhaust Manifold Auspuffkrümmer Collecteur D'echappement</p> 	<p>Eksoz Boğaz Exhaust Pipe Auspuff Kehle</p> 	<p>Supap Keçesi Valve Stem Seal Ventilschaft Queue de soupape</p> 	
 <p>61406034 1378909-4</p>  <p>61406035 463416-8</p>	 <p>61406013 1378864-1</p>	 <p>61406019 1378879-9</p>	 <p>61406020x4 1378217-2</p>	 <p>61406017 1266713-5</p>		
 <p>61406034 1378909-4</p>  <p>61406035 463416-8</p>	 <p>61406013 1378864-1</p>	 <p>61406019 1378879-9</p>	 <p>61406020x4 1378217-2</p>	 <p>61406017 1266713-5</p>		

■ : Delik - Çentik

■ : Hole - Notch

■ : Trou - Entaille

NOT: Katalogdaki Orijinal Kodlar Referans Amacıyla Kullanılmıştır. Lütfen COTECH Kodlarını Kullanınız.
Original codes used for reference only. Please use COTECH codes for orders.

00



Silindir Kapak
Cylinder Head
Zylinderkopf
Joint de culasse

01



02



03



04

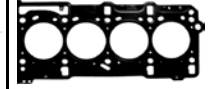

Ltr	MODEL	PS/KW	ENGINE/MOTOR		
2,3 2316	4 CYL ø96 240 08/1978-->12/1988 242 1978--> 244 1978--> 244 08/1978-->12/1988 245 1978--> 740 1978--> 760 1978--> 240 08/1980-->07/1984 242 1981--> 244 08/1979-->07/1984 245 08/1980-->07/1984 740 08/1984-->07/1990 744 08/1984-->07/1990	136 PS / 100 KW 136 PS / 100 KW 136 PS / 100 KW 136 PS / 100 KW 136 PS / 100 KW 136 PS / 100 KW 136 PS / 100 KW 112 PS / 82 KW 112 PS / 82 KW 112 PS / 82 KW 112 PS / 82 KW 112 PS / 82 KW 114 PS / 84 KW	B23E/F/T B23E/F/T B23E/F/T B23E/F/T B23E/F/T B23E/F/T B23E/F/T B23A B23A B23A B23A B23A B23A	61406000 270684-4 270685-1	 61406005 1378646-2 1,50mm ø98
2,3 2316	4 CYL ø96 240 08/84-->07/86 740 240 08/83-->10/98 740 740 T 760 760 T 940 940 T 740 08/87-->08/92 940	112 PS / 82 KW 110 PS / 81 KW 190 PS / 140 KW 113 PS / 83 KW 159 PS / 117 KW 151 PS / 111 KW	B 230 A B 230 E B 230 ET B 230 F B 230 FB B 230 FD B 230 FK B 230 FT B 230 FT+ B 230 G B 230 GK B 230 GT B 230 K B 234 F B 234 G		 61406005 1378646-2 1,50mm ø98
2,7 2664	6 CYL ø88 260 08/75-->07/82 240 08/74-->07/82 260	125 PS / 92 KW 148 PS / 109 KW 140 PS / 103 KW	B 27 A B 27 E B 27 F		 245 291-0 1,20mm 245 585-5 1,20mm ø90 60115005

▲ : İçerikte Bulunmamaktadır...

▲ : Not included in the set

▲ : Non inclus dans la pochette

00: Motor Takım Keçesiz ve Subap Lastiksiz









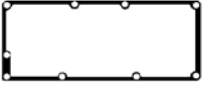
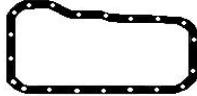

00: Gasket Set Without oil seals Without Valve Stem Seal

01: Motor Takım Keçesiz - Subap Lastikli

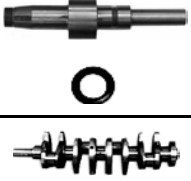
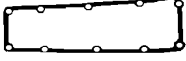
01: Gasket set With Valve Stem Seal Without Oil Seals

02: Motor Full Takım Keçeli ve Subap Lastikli

02: Gasket Full Set With oil seals and Valve Stem Seals

<p>Subap Kapak Valve Cover Gasket Zylinderkopfhaube Couvre-culbut.</p> 	<p>Karter Oil Pan Ölwanne Carter d'huile</p> 	<p>Emme Manifold Intake Manifold Ansaug Admission</p> 	<p>Egzoz Manifold Exhaust Manifold Auspuffkrümmer Collecteur D'echappement</p> 	<p>Eksoz Boğaz Exhaust Pipe Auspuff Kehle</p> 	<p>Supap Keçesi Valve Stem Seal Ventilschaft Queue de soupape</p> 	
 <p>61406034 1378909-4</p>  <p>61406035 463416-8</p>	 <p>61406013 1378864-1</p>	 <p>61406019 1378879-9</p>	 <p>61406020x4 1378217-2</p>	 <p>61406017 1266713-5</p>		

■ : Delik - Çentik

■ : Hole - Notch

■ : Trou - Entaille

NOT: Katalogdaki Orijinal Kodlar Referans Amacıyla Kullanılmıştır.Lütfen COTECH Kodlarını Kullanınız.
Original codes used for reference only.Please use COTECH codes for orders.

00



Silindir Kapak
Cylinder Head
Zylinderkopf
Joint de culasse

01



02



03



04

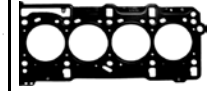

Ltr	MODEL	PS/KW	ENGINE/MOTOR		
1,0 999	4 CYL ø67 POLO FOX 02/03-->10/03 10/03-->	79 PS / 58 KW 73 PS / 54 KW 65 PS / 48 KW	ARA AQZ AZN BJE BJR BNW BNX BTY CCNA		 61415005 036 103 383 AF 1,20mm FIBER / FIBRE ø68
1,4 1390	4 CYL ø76,5 BORA CADDY GOLF LUPO POLO 08/97--> GOLF POLO 05/06-->	101 PS / 74 KW 74 PS / 55 KW 80 PS / 59 KW 85 PS / 63 KW 80 PS / 59 KW	AFK AHW AKQ ANM APE AQQ AUA AUB AXP BBY BBZ BCA BCC BKY BUD CGGA CGGB CMAA	61405303	 61405305 036 103 383 AM MLS ø77,5
1,5 1457	4 CYL ø79,5 CADDY GOLF JETTA SCIROCCO 08/77-->02/84	70 PS / 51 KW	GH JB	61401002 049 198 001 C 61401003 049 198 012 H 61401004 037 198 011 C	 61401005 049 103 383 K 1,60mm ø81

▲ : İçerikte Bulunmamaktadır...

▲ : Not included in the set

▲ : Non inclus dans la pochette

00: Motor Takım Keçesiz ve Subap Lastiksiz











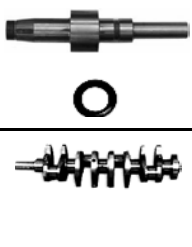
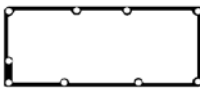

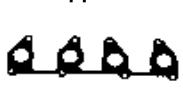



00: Gasket Set Without oil seals Without Valve Stem Seal

01: Motor Takım Keçesiz - Subap Lastikli

01: Gasket set With Valve Stem Seal Without Oil Seals

02: Motor Full Takım Keçeli ve Subap Lastikli

02: Gasket Full Set With oil seals and Valve Stem Seals

Subap Kapak Valve Cover Gasket Zylinderkopfhaube Couvre-culbut.	Karter Oil Pan Ölwanne Carter d'huile	Emme Manifold Intake Manifold Ansaug Admission	Egzoz Manifold Exhaust Manifold Auspuffkrümmer Collecteur D'echappement	Eksoz Boğaz Exhaust Pipe Auspuff Kehle	Supap Keçesi Valve Stem Seal Ventilschaft Queue de soupape	
						
						21204029x2 27x42x8 RD
62427465	62427465	61405319x6 036 129 717 E	61405321 036 253 039 F		62457127x16 036 109 675 6x8,8x12,2x9,7	
						21201075x3 32x47x10 W 21204504 85x105x12 LD
61401034 026 198 025 A	61401013 028 103 609 A	61401019 026 129 717 D	61401021x4 026 129 589 A 056 129 589 B	61401017 841 253 115 B	60107027x8 026 109 675 8x10,8/14,2x10	

 : Delik - Çentik

 : Hole - Notch

 : Trou - Entaille

NOT: Katalogdaki Orijinal Kodlar Referans Amacıyla Kullanılmıştır.Lütfen COTECH Kodlarını Kullanınız.
Original codes used for reference only.Please use COTECH codes for orders.

00



01



02



03







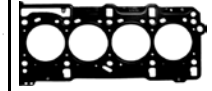

04



Silindir Kapak
Cylinder Head
Zylinderkopf
Joint de culasse



Ltr	MODEL	PS/KW	ENGINE/MOTOR		
1,6 1588	4 CYL ø76,5 GOLF D 08/80-->07/85 GOLF TD JETTA D JETTA TD PASSAT D PASSAT TD SANTANA D SANTANA TD TRANSPORTER DASHER D CADDY D	54 PS / 40 KW 70 PS / 51 KW 54 PS / 40 KW 70 PS / 51 KW 54 PS / 40 KW 70 PS / 51 KW 54 PS / 40 KW 70 PS / 51 KW 70 PS / 51 KW 54 PS / 40 KW 54 PS / 40 KW	CR ; JK ; JP ; JR CR ; JK ; JP ; JR CR ; JK ; JP ; JR CR ; JK ; JP ; JR CR ; JK ; CY CR ; JK ; CY CR ; JK ; CY CR ; JK ; CY CS ; JX JF CR ; JK ; JP	61402002 Motor Full Takım Gasket Full Set  61402003 068 198 012 L 068 198 012 E 033 198 012 A  61402004 037 198 011 C	 61402005 068 103 383 FN 1,60mm 3 ■ 61402006 068 103 383 FM 1,50mm 2 ■ 61402007 068 103 383 FL 1,40mm 1 ■ ø78,5
1,6 1588	4 CYL ø76,5 GOLF D 08/85-->07/93 GOLF TD JETTA D JETTA TD PASSAT D PASSAT TD SANTANA D SANTANA TD CADDY D TRANSPORTER	70 PS / 51 KW 80 PS / 59 KW 70 PS / 51 KW 80 PS / 59 KW 70 PS / 51 KW 80 PS / 59 KW 70 PS / 51 KW 80 PS / 59 KW 54 PS / 40 KW 70 PS / 51 KW	CR ; ME ; JK ; JP ; 1V CR ; JR ; RA ; SB CR ; ME ; SV ; JK ; JP ; 1V CR ; JK ; JR ; RA ; SB ; SV ; 1V CY ; JK ; JP ; RA ; SB CY ; JK ; JP ; RA ; SB CY ; JK ; JP CY ; JK ; JP CR ; ME ; JK CS ; JX	61402002 Motor Full Takım Gasket Full Set  61402003 068 198 012 L 068 198 012 E 033 198 012 A  61402004 037 198 011 C	 61403005 068 103 383 EK 1,61mm 3 ■ 61403006 068 103 383 EJ 1,57mm 2 ■ 61403007 068 103 383 EH 1,53mm 1 ■ ø78,5
1,6 1595	4 CYL ø81 CADDY 01/83-->07/92 GOLF JETTA PASSAT SCIROCCO	75 PS / 55 KW 70 PS / 51 KW	EW EWA EZ EZA HM HN PN RE RF 1F	61408002 Motor Full Takım Gasket Full Set 61408003 027 198 012 L 61402004 037 198 011 C	 61408005 026 103 383 P 026 103 383 L 026 103 383 M 026 103 383 N 026 103 383 K 1,75mm ø83

▲ : İçerikte Bulunmamaktadır...

▲ : Not included in the set

▲ : Non inclus dans la pochette

00: Motor Takım Keçesiz ve Subap Lastiksiz











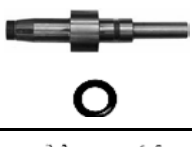
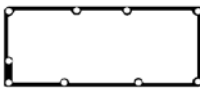















00: Gasket Set Without oil seals Without Valve Stem Seal

01: Motor Takım Keçesiz - Subap Lastikli

01: Gasket set With Valve Stem Seal Without Oil Seals

02: Motor Full Takım Keçeli ve Subap Lastikli

02: Gasket Full Set With oil seals and Valve Stem Seals

Subap Kapak Valve Cover Gasket Zylinderkopfhaube Couvre-culbut.	Karter Oil Pan Ölwanne Carter d'huile	Emme Manifold Intake Manifold Ansaug Admission	Egzoz Manifold Exhaust Manifold Auspuffkrümmer Collecteur D'échappement	Eksoz Boğaz Exhaust Pipe Auspuff Kehle	Supap Keçesi Valve Stem Seal Ventilschaft Queue de soupape	
						
 61401034 026 103 483 026 103 483 B 026 103 483 C 056 103 483 D	 61401013 028 103 609 A 034 129 717 C	 61401019 026 129 717D  61402019 068 129 717 E	 61401021x4 026 129 589 A 028 129 589 B	 61401017 841 253 115 B	 60107027x8 026 109 675 8x10,8/14,2x10	21201075x3 32x47x10 WD 21204504 85x105x12 LD
 61401034 026 103 483 026 103 483 B 026 103 483 C 056 103 483 D	 61401013 028 103 609 A 034 129 717 C	 61401019 026 129 717D  61402019 068 129 717 E	 61401021x4 026 129 589 A 028 129 589 B	 61401017 841 253 115 B	 60107027x8 026 109 675 8x10,8/14,2x10	21201075x3 32x47x10 WD 21204504 85x105x12 LD
 61401034 026 103 483 026 103 483 B 026 103 483 C 056 103 483 D	 61401013 028 103 609 A 034 129 717 C	 61401019 026 129 717D	 61401021x4 026 129 589 A 028 129 589 B	 61401017 841 253 115 B	 60107027x8 026 109 675 8x10,8/14,2x10	21201075x3 32x47x10 WD 21204504 85x105x12 LD

 : Delik - Çentik

 : Hole - Notch

 : Trou - Entaille

NOT: Katalogdaki Orijinal Kodlar Referans Amacıyla Kullanılmıştır.Lütfen COTECH Kodlarını Kullanınız.
Original codes used for reference only.Please use COTECH codes for orders.

00



Silindir Kapak
Cylinder Head
Zylinderkopf
Joint de culasse

01



02



03



04

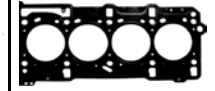

Ltr	MODEL	PS/KW	ENGINE/MOTOR		
1,6 1588	4 CYL ø79,5 GOLF GTI 06/76--> PASSAT SCIROCCO CADDY 08/75-->03/88 GOLF JETTA PASSAT SANTANA SCIROCCO PASSAT 08/75--> SCIROCCO	110 PS / 81 KW 81 PS / 60 KW 85 PS / 63 KW 75 PS / 55 KW 85 PS / 63 KW 65 PS / 48 KW	EG YH YS EM FP FR WV WY YN YP FN FR FT FV WP YN YP YY	61401002 049 198 001 C 61401003 049 198 012 H 61401004 037 198 011 C	 61401005 049 103 383 K 1,60mm ø81
1,6 1598	4 CYL ø76,5 GOLF 09/92-->09/98 VENTO	75 PS / 55 KW	ABU		 61400305 032 103 383 G 032 103 383 H 1,60mm ø77,5
1,7 1716	4 CYL ø79,5 TRANSPORTER 08/85-->07/92	57 PS / 42 KW	KY	61402002 Motor Full Takım Gasket Full Set 61402003 068 198 012 L 068 198 012 E 033 198 012 A 61402004 037 198 011 C	 61404005 033 103 383 M 1,61mm 3 61404006 033 103 383 L 1,57mm 2 61404007 033 103 383 K 1,53mm 1 ø81

▲ : İçerikte Bulunmamaktadır...

▲ : Not included in the set

▲ : Non inclus dans la pochette

00: Motor Takım Keçesiz ve Subap Lastiksiz











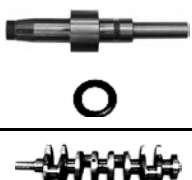
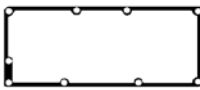









00: Gasket Set Without oil seals Without Valve Stem Seal

01: Motor Takım Keçesiz - Subap Lastikli

01: Gasket set With Valve Stem Seal Without Oil Seals

02: Motor Full Takım Keçeli ve Subap Lastikli

02: Gasket Full Set With oil seals and Valve Stem Seals

Subap Kapak Valve Cover Gasket Zylinderkopfhaube Couvre-culbut.	Karter Oil Pan Ölwanne Carter d'huile	Emme Manifold Intake Manifold Ansaug Admission	Egzoz Manifold Exhaust Manifold Auspuffkrümmer Collecteur D'echappement	Eksoz Boğaz Exhaust Pipe Auspuff Kehle	Supap Keçesi Valve Stem Seal Ventilschaft Queue de soupape	
						 
 61401034 026 198 025 A	 61401013 028 103 609 A	 61401019 026 129 717 D	 61401021x4 026 129 589 A 056 129 589 B	 61401017 841 253 115 B	 60107027x8 026 109 675 8x10,8/14,2x10	21201075x3 32x47x10 W 21204504 85x105x12 LD
 61401034 026 103 483 026 103 483 B 026 103 483 C 056 103 483 D	 61401013 028 103 609 A 034 129 717 C	 61402019 068 129 717 E  61401019 026 129 717D	 61401021x4 026 129 589 A 028 129 589 B	 61401017 841 253 115 B	 60107027x8 026 109 675 8x10,8/14,2x10	21201075x3 32x47x10 WD 21204504 85x105x12 LD

 : Delik - Çentik

 : Hole - Notch

 : Trou - Entaille

NOT: Katalogdaki Orijinal Kodlar Referans Amacıyla Kullanılmıştır.Lütfen COTECH Kodlarını Kullanınız.
Original codes used for reference only.Please use COTECH codes for orders.

00



01



02



03



04



Silindir Kapak
Cylinder Head
Zylinderkopf
Joint de culasse



Ltr	MODEL	PS/KW	ENGINE/MOTOR		
1,7 1716	4 CYL ø79,5 CADDY SDI 07/96-->09/00 POLO SDI 04/97-->10/99 LUPO SDI 08/97-->07/05 POLO SDI 08/97-->07/05 POLO SDI 07/97-->09/01	57 PS / 42 KW 57 PS / 42 KW 60 PS / 44 KW 60 PS / 44 KW 60 PS / 44 KW	AHB AHG AKU AKU AKW		<p>61405205 028 103 383 BR 028 103 383 BN 1,61mm 3 ■</p> <p>61405206 028 103 383 BQ 028 103 383 BM 1,53mm 2 ■</p> <p>61405207 028 103 383 BP 028 103 383 BL 1,45mm 1 ■</p> <p>MLS ø81</p>
1,8 1812	4 CYL ø86 TARO 05/89-->09/94	83 PS / 61 KW	2Y		<p>61411605 11115-71010 1,80mm</p> <p>61411606 11115-71010 2,0mm ø88</p>
1,8 1781	4 CYL ø81 CADDY 08/82-->07/93 GOLF GOLF GTI JETTA PASSAT SCIROCCO SCIROCCO GTI	112 PS / 82 KW 84 PS / 62 KW 90 PS / 66 KW 98 PS / 72 KW	EV EX GU GX GZ HT HV JH KT RD RG RH RP RV 1P PB PF 2H	<p>61408002 Motor Full Takım Gasket Full Set</p> <p>61408003 027 198 012 L</p> <p>61402004 037 198 011 C</p>	<p>61408005 026 103 383 P 026 103 383 L 026 103 383 M 026 103 383 N 026 103 383 K 1,75mm ø83</p>

00: Motor Takım Keçesiz ve Subap Lastiksiz











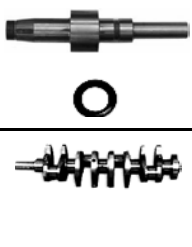
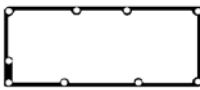

01: Motor Takım Keçesiz - Subap Lastikli

02: Motor Full Takım Keçeli ve Subap Lastikli

00: Gasket Set Without oil seals Without Valve Stem Seal

01: Gasket set With Valve Stem Seal Without Oil Seals

02: Gasket Full Set With oil seals and Valve Stem Seals

Subap Kapak Valve Cover Gasket Zylinderkopfhaube Couvre-culbut.	Karter Oil Pan Ölwanne Carter d'huile	Emme Manifold Intake Manifold Ansaug Admission	Egzoz Manifold Exhaust Manifold Auspuffkrümmer Collecteur D'echappement	Eksoz Boğaz Exhaust Pipe Auspuff Kehle	Supap Keçesi Valve Stem Seal Ventilschaft Queue de soupape	
						
						<p>21201075x3 32x47x10 WD</p> <p>21204504 85x105x12 LD</p>
<p>61401034 026 103 483 026 103 483 B 026 103 483 C 056 103 483 D</p>	<p>61401013 028 103 609 A 034 129 717 C</p>	<p>61401019 026 129 717D</p>	<p>61401021x4 026 129 589 A 028 129 589 B</p>	<p>61401017 841 253 115 B</p>	<p>60107027x8 026 109 675 8x10,8/14,2x10</p>	

 : Delik - Çentik

 : Hole - Notch

 : Trou - Entaille

NOT: Katalogdaki Orijinal Kodlar Referans Amacıyla Kullanılmıştır.Lütfen COTECH Kodlarını Kullanınız.
Original codes used for reference only.Please use COTECH codes for orders.

00



01



02



03



04



Silindir Kapak
Cylinder Head
Zylinderkopf
Joint de culasse

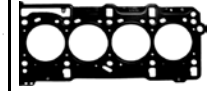

Ltr	MODEL	PS/KW	ENGINE/MOTOR			
1,8 1781	4 CYL ø81 SCIROCCO 16V 09/85-->10/91 JETTA 16V PASSAT 16V CORRADO 16V GOLF 16V PASSAT 08/91-->02/99 GOLF VENTO JETTA GOLF	136 PS / 100 KW 129 PS / 95 KW 90 PS / 66 KW 75 PS / 55 KW	KR JH PL 2H AAM ABS ADZ ADD			 61408005 026 103 383 P 026 103 383 L 026 103 383 M 026 103 383 N 026 103 383 K 1,75mm ø83
1,9 1896	4 CYL ø79,5 GOLF TD 03/91-->04/99 PASSAT TD VENTO TD -->AAZ 462 614 TRANSPORTER 07/90-->04/03 -->1X 104 630 CADDY D 05/89-->01/04 GOLF D PASSAT D POLO D VENTO D -->1Y 315 599	75 PS / 55 KW 61 PS / 45 KW 60 PS / 44 KW 68 PS / 50 KW 64 PS / 47 KW	AAZ 1X 1Y	61405102 Motor Full Takım Gasket Full Set 61405103 028 198 012 B 61405104 028 198 011 D	 61405105 028 103 383 BD 1,70mm 3 ■ 61405106 028 103 383 BC 1,65mm 2 ■ 61405107 028 103 383 BB 1,60mm 1 ■ ø81	
1,9 1896	4 CYL ø79,5 GOLF TDI 03/96-->06/02 PASSAT TDI POLO TDI SHARAN TDI VENTO TDI -->AFN 002 000 CADDY TDI 09/93-->03/10 GOLF TDI PASSAT TDI POLO TDI SHARAN TDI VENTO TDI CADDY TDI 09/93-03/10 GOLF TDI PASSAT TDI SHARAN TDI VENTO TDI -->1Z 770 000	110 PS / 81 KW 115 PS / 85 KW 90 PS / 66 KW	AFN AHU 1Z	61405202 Motor Full Takım Gasket Full Set 61405203 028 198 012 C 61405104 028 198 011 D	 61405205 028 103 383 BR 028 103 383 BN 1,61mm 3 ■ 61405206 028 103 383 BQ 028 103 383 BM 1,53mm 2 ■ 61405207 028 103 383 BP 028 103 383 BL 1,45mm 1 ■ MLS ø81	

▲ : İçerikte Bulunmamaktadır...

▲ : Not included in the set

▲ : Non inclus dans la pochette

00: Motor Takım Keçesiz ve Subap Lastiksiz











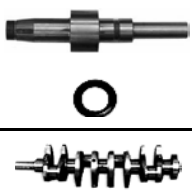
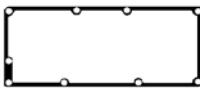

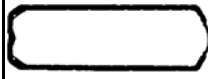

00: Gasket Set Without oil seals Without Valve Stem Seal

01: Motor Takım Keçesiz - Subap Lastikli

01: Gasket set With Valve Stem Seal Without Oil Seals

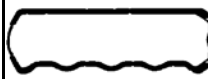
02: Motor Full Takım Keçeli ve Subap Lastikli

02: Gasket Full Set With oil seals and Valve Stem Seals

Subap Kapak Valve Cover Gasket Zylinderkopfhaube Couvre-culbut.	Karter Oil Pan Ölwanne Carter d'huile	Emme Manifold Intake Manifold Ansaug Admission	Egzoz Manifold Exhaust Manifold Auspuffkrümmer Collecteur D'echappement	Eksoz Boğaz Exhaust Pipe Auspuff Kehle	Supap Keçesi Valve Stem Seal Ventilschaft Queue de soupape	
						
						21208042 32x47x10 WD
61405125 028 103 483 F 028 103 483 H		61405121 028 129 717 D	61401021x4 026 129 589 A 028 129 589 B		60107027x8 026 109 675 8x10,8/14,2x10	21204504 85x105x12 LD
						21208042x2 32x47x10 WD
						21208042 32x47x10 WD
61405225 028 103 483 C 028 103 483 G		61405121 028 129 717 D	61401021x4 026 129 589 A 028 129 589 B		60107027x8 026 109 675 8x10,8/14,2x10	21204504 85x105x12 LD
						21208042x2 32x47x10 WD

 : Delik - Çentik

 : Hole - Notch

 : Trou - Entaille

NOT: Katalogdaki Orijinal Kodlar Referans Amacıyla Kullanılmıştır.Lütfen COTECH Kodlarını Kullanınız.
Original codes used for reference only.Please use COTECH codes for orders.

00



Silindir Kapak
Cylinder Head
Zylinderkopf
Joint de culasse

01



02



03



04

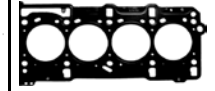

Ltr	MODEL	PS/KW	ENGINE/MOTOR	
1,9 1986	4 CYL ø79,5 CADDY SDI 07/95-->01/04 GOLF SDI 07/95-->01/04 POLO SDI 07/95-->01/04 VENTO SDI 07/95-->01/04 POLO SDI 07/96-->09/01 GOLF TDI 09/96-->06/02 PASSAT TDI 09/96-->06/02 SHARAN TDI 09/96-->06/02 CADDY TDI 09/93-->01/04 GOLF TDI 09/93-->01/04 POLO TDI 09/93-->01/04 VENTO TDI 09/93-->01/04 POLO SDI 10/99-->09/01	64 PS / 47 KW 64 PS / 47 KW 64 PS / 47 KW 64 PS / 47 KW 64 PS / 47 KW 110 PS / 81 KW 90 PS / 66 KW 90 PS / 66 KW 90 PS / 66 KW 90 PS / 66 KW 90 PS / 66 KW 90 PS / 66 KW 64 PS / 47 KW	AEY AEY AEY AEY AGD AHH AVG AVG ALE ALE ALE ALE ASX	 61405205 028 103 383 BR 028 103 383 BN 1,61mm 3 ▲ 61405206 028 103 383 BQ 028 103 383 BM 1,53mm 2 ▲ 61405207 028 103 383 BP 028 103 383 BL 1,45mm 1 ▲ MLS ø81
2,0 1984	4 CYL ø82,5 GOLF GTI 08/92-02/00 PASSAT SHARAN ...->ABF 031 251 GOLF 02/90-04/99 PASSAT VENTO CORRADO 08/88-12/95 PASSAT	150 PS / 110 KW 115 PS / 85 KW 136 PS / 100 KW	ABF 2E 9A	 61408105 048 103 383 B 1,75mm ø83,5
2,2 2237	4 CYL ø91 TARO 06/89-->07/94	94 PS / 69 KW	4Y	 61411105 11115-73010 1,60mm 61411106 11115-73010 2,00mm ø93

▲ : İçerikte Bulunmamaktadır...

▲ : Not included in the set

▲ : Non inclus dans la pochette

00: Motor Takım Keçesiz ve Subap Lastiksiz





00: Gasket Set Without oil seals Without Valve Stem Seal

01: Motor Takım Keçesiz - Subap Lastikli

01: Gasket set With Valve Stem Seal Without Oil Seals

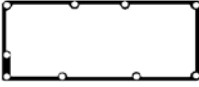
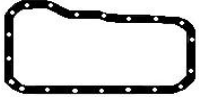
02: Motor Full Takım Keçeli ve Subap Lastikli

02: Gasket Full Set With oil seals and Valve Stem Seals

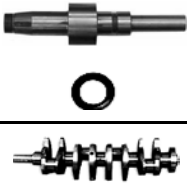
<p>Subap Kapak Valve Cover Gasket Zylinderkopfhaube Couvre-culbut.</p> 	<p>Karter Oil Pan Ölwanne Carter d'huile</p> 	<p>Emme Manifold Intake Manifold Ansaug Admission</p> 	<p>Egzoz Manifold Exhaust Manifold Auspuffkrümmer Collecteur D'echappement</p> 	<p>Eksoz Boğaz Exhaust Pipe Auspuff Kehle</p> 	<p>Supap Keçesi Valve Stem Seal Ventilschaft Queue de soupape</p> 	

■ : Delik - Çentik

■ : Hole - Notch

■ : Trou - Entaille

NOT: Katalogdaki Orijinal Kodlar Referans Amacıyla Kullanılmıştır.Lütfen COTECH Kodlarını Kullanınız.
Original codes used for reference only.Please use COTECH codes for orders.

00



Silindir Kapak

Cylinder Head

01



Zylinderkopf

02



Joint de culasse

03



04

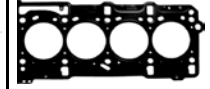

Ltr	MODEL	PS/KW	ENGINE/MOTOR		
2,4					
2370	TRANSPORTER 07/90-->09/98 B70 R 160 001-->	78 PS / 57 KW	AAB	62403002	
	TRANSPORTER 08/97-->04/03	75 PS / 55 KW	AJA	074 198 012 A	
2,5					
2461	TRANSPORTER 09/95-->04/03	102 PS / 75 KW	ACV		
	LT SDI 07/96-->07/06	75 PS / 55 KW	AGX		
	LT TDI 05/96-->08/99	102 PS / 75 KW	AHD		

▲ : İçerikte Bulunmamaktadır...

▲ : Not included in the set

▲ : Non inclus dans la pochette

00: Motor Takım Keçesiz ve Subap Lastiksiz









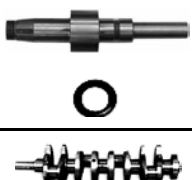
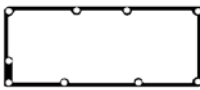

00: Gasket Set Without oil seals Without Valve Stem Seal

01: Motor Takım Keçesiz - Subap Lastikli

01: Gasket set With Valve Stem Seal Without Oil Seals

02: Motor Full Takım Keçeli ve Subap Lastikli

02: Gasket Full Set With oil seals and Valve Stem Seals

Subap Kapak Valve Cover Gasket Zylinderkopfhaube Couvre-culbut.	Karter Oil Pan Ölwanne Carter d'huile	Emme Manifold Intake Manifold Ansaug Admission	Egzoz Manifold Exhaust Manifold Auspuffkrümmer Collecteur D'echappement	Eksoz Boğaz Exhaust Pipe Auspuff Kehle	Supap Keçesi Valve Stem Seal Ventilschaft Queue de soupape	
						
	 62403013 074 103 609 F	 62403019 074 129 717	 62403021x5 026 129 589 A 028 129 589 B		 60107127x10 026 109 675 8x10,8x14,2x10	21208042x2 32x47x10 WD 21208026 35x48x10 RD 21204504 85x105x11 LD

 : Delik - Çentik

 : Hole - Notch

 : Trou - Entaille

NOT: Katalogdaki Orijinal Kodlar Referans Amacıyla Kullanılmıştır.Lütfen COTECH Kodlarını Kullanınız.
Original codes used for reference only.Please use COTECH codes for orders.

00



Silindir Kapak

Cylinder Head

01



Zylinderkopf

02



Joint de culasse

03



04

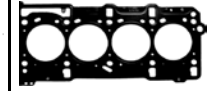

Ltr	MODEL	PS/KW	ENGINE/MOTOR		
	4 CYL GAZ 24				<p>64020005 24-100 30 20 ø92</p>
	4 CYL GAZ 24				<p>64022005 ø100 Elipse</p>
	4 CYL GAZ 2401-2405				<p>64004005 402 1000 3020 ø93 Elipse</p>
	4 CYL GAZ 2217 - 2705 -2752 - 3110 3221 -3302				<p>60004605 406 - 100 30 20 ø97,5</p>
	4 CYL GAZ 406				<p>60004705 ø97,5 Elipse</p>
	4 CYL MEMZ - 245 / 2451 / 2457				<p>64015005 1,40mm</p>

▲ : İçerikte Bulunmamaktadır...

▲ : Not included in the set

▲ : Non inclus dans la pochette

00: Motor Takım Keçesiz ve Subap Lastiksiz

00: Gasket Set Without oil seals Without Valve Stem Seal

01: Motor Takım Keçesiz - Subap Lastikli

01: Gasket set With Valve Stem Seal Without Oil Seals

02: Motor Full Takım Keçeli ve Subap Lastikli

02: Gasket Full Set With oil seals and Valve Stem Seals

00



Silindir Kapak
Cylinder Head

01



Zylinderkopf

02





Joint de culasse

03

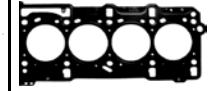

04



Ltr	MODEL	PS/KW	ENGINE/MOTOR		
1,6 1587	4 CYL ø78,5 207i PARS 206SD RUNNA SAMAND SOREN	H1-H2 LX V1-V2-V10-V8-V9 LX - SE ELX	TU5JP	62200102 Motor Full Takım Gasket Full Set 62200103 Motor Üst Takım Gasket Head Set 62200004 Motor Alt Takım Conversion Set	62200005 0209.1E MLS ø79,5
1,8 1761	4 CYL ø83 SAMAND SARIR SOREN	LX - SE ELX	XU7	61233002 0197.G4+0209.E1	61207005 0209.E1 1,30mm 1  61207006 0209.L8 1,50mm 2  62130005 0209.L3 1,50mm ø84,5
1,7 1645	4 CYL DENA SAMAND SOREN	NA-ELX-TC LX ELX	EF7	62210001 Motor Full Takım Gasket Full Set	62210005 0,50mm ø80

▲ : İçerikte Bulunmamaktadır...

▲ : Not included in the set

▲ : Non inclus dans la pochette

00: Motor Takım Keçesiz ve Subap Lastiksiz











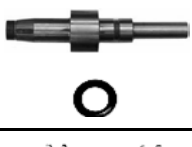
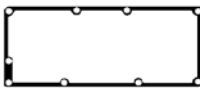



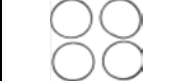

00: Gasket Set Without oil seals Without Valve Stem Seal

01: Motor Takım Keçesiz - Subap Lastikli

01: Gasket set With Valve Stem Seal Without Oil Seals

02: Motor Full Takım Keçeli ve Subap Lastikli

02: Gasket Full Set With oil seals and Valve Stem Seals

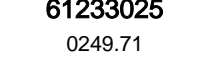
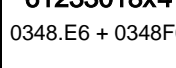
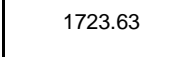
Subap Kapak Valve Cover Gasket Zylinderkopfhaube Couvre-culbut.	Karter Oil Pan Ölwanne Carter d'huile	Emme Manifold Intake Manifold Ansaug Admission	Egzoz Manifold Exhaust Manifold Auspuffkrümmer Collecteur D'echappement	Eksoz Boğaz Exhaust Pipe Auspuff Kehle	Supap Keçesi Valve Stem Seal Ventilschaft Queue de soupape	
						
62200024 0249.C6	62200065 0304.55	62200018x4 0348.Q5	62200021 0349.J4	62200017 1709.25	62427426x16 0956.40 6x8,8x11,7x9,5	21201741x2 38x50x6 RD
						21201021 42x66x6 RD
61233025 0249.71	61203013 0304.34 93502226.	61233018x4 0348.E6 + 0348F6	61233020x4 1723.63			21204504 85x105x8 LD
					60107027x8 0956.22 8x10,8/14,2x10	21201062 36x50x7 RD
						21201019 42x62x8 RD
62210025		62210019	62210021			21201040 90x110x10 LD

 : Delik - Çentik

 : Hole - Notch

 : Trou - Entaille

NOT: Katalogdaki Orijinal Kodlar Referans Amacıyla Kullanılmıştır.Lütfen COTECH Kodlarını Kullanınız.
Original codes used for reference only.Please use COTECH codes for orders.