

# COTECH®

## SEALING PRODUCTS

Gaskets • Dichtungen • Joints • Juntas • Guarnizioni

100%  
PREMIUM  
— Quality —

NON ASBESTOS



*High Quality Gasket*



CITROEN-FIAT-HONDA-HYUNDAI-JOHNDERE-LADA  
MITSUBISHI -OPEL-PERKINS-PEUGEOT-RENAULT  
SKODA -VOLKSWAGEN-VOLVO

→ [www.cotechgasket.com](http://www.cotechgasket.com)

I.O.S.B Çevre Sanayi Sitesi 5 Blok  
No:6 İkitelli - Başakşehir / İSTANBUL/TURKEY

Tel: +90 212 485 89 02 Pbx Fax: +90 212 485 89 03  
info@cotechgasket.com

En gelişmiş üretim teknolojilerinin kullanıldığı **COTECH**, çok geniş bir marka ve model yelpazesinde sürdürdüğü üretimine, her geçen gün yeni marka ve model ailelerini ekleyerek, birlikte çalıştığı firmaların da ihtiyaçlarını eksiksiz karşılamak ve piyasada rekabet şanslarını en yüksek seviyede tutmayı hedefleyerek desteklemektedir.

**COTECH**, kurulduğu ilk günden bugüne sahip olduğu ve hiç bir surette ödün vermediği prensipler olan kaliteli ürün koşulsuz müşteri memnuniyetine yönelik prensipleri ile hizmetine devam etmekten gurur ve mutluluk duymaktadır.

Ürettiği ürünlerin yanısıra marka olarak her zaman tercih edilmiş olan **COTECH**, sahip olduğu **ISO 9001: 2000** kalite standartlarına uygunluk belgesi ile ürünlerinin kalitesini belgelendirmiştir.

**COTECH**, ürünlerinin siparişten başlayarak hazırlık, üretim, paketleme, depolama ve sevkiyat aşamalarında kontrol ve takibi dünya çapında tescilli barkodlar ile yürütmektedir.

Yıllık olarak gerçekleştirdiği üretiminin %30'u iç piyasada alıcı bulurken, %70'i ise yurt dışı pazarda satışa sunulmaktadır.

**COTECH**; gelişim ve yeniliklere açıklık ilkesine, yarım asıra yaklaşan bilgi birikimi ve tecrübesini de ekleyerek üretimde çağın gerektirdiği şartları yerine getirmiştir.



**COTECH** is manufacturing auto gaskets for wide range of brands and model families with the latest manufacturing technology and always adding new brands and model families to their products to fulfill the market with the highest rate of competition opportunity.

**COTECH** feels the proud of to follow up and to protect two principles since the first day;

- Production and Service Quality
- Complete Customer Saticfastion

**COTECH** holds **ISO 9001: 2000** Quality Assurance Cetificate for their products and their products and their brand that always preferred in the mrket trustfully.

**COTECH** uses worldwide registered barcodes during all steps of manufacturing, packaging, storage and product flow.

30% of annual production of **COTECH** is sold in domestic market and 70% of annual production purchased in foreing market.

**COTECH** is keeping on it's production with the experience of development as a part of it's principles that form the genuine of the company.

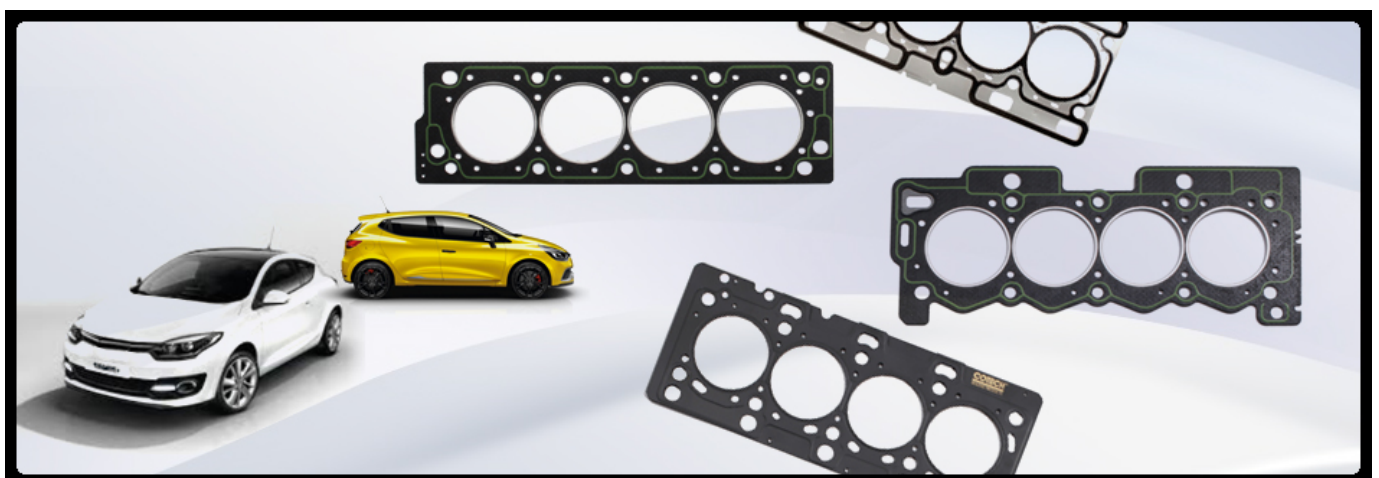

### Silindir Kapak Contaları:

Silindir kapak conta, silindir kafası ve blok arasına yerleştirilmiştir. Isı, mekanik ve kimyasal etkenlere direnç gösterir. Conta çeşitli sıcaklıklar arasında kusursuz sızdırmazlık gerektirir. Contanın montajı esnasında contaya herhangi bir zarar verilmemeli ve tork anahtarı ile fabrikanın önerdiği derecede sıkma işlemi gerçekleştirilmelidir.

### Cylinder Head Gasket:

Situated between the cylinder head and the block, the cylinder head gasket is punished by increasingly greater stresses: thermal, mechanical and chemical. It must ensure a flawless seal across a wide range of temperatures, despite being tightened with a limited torque setting so as not to damage or weaken the cylinder head and at the same time withstand the inevitable movements between cylinder head and block.

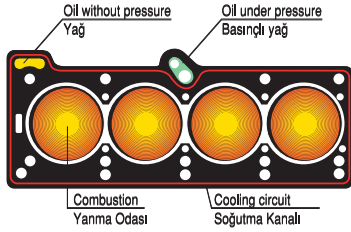

	Sıcaklık / Temperature (°C)	Basınç / Pressure (bars)
Sıkıştırılmış gazlar / Combustion gases	> 1000	70 - 160 (TDI)
Yağ / Oil	-30 - 150	0 - 7
Su (antifriz) / Water (cooling liquid)	-30 - 110	0.5 - 1.5

### Dizel ve Turbo Dizel Araçlar:

Dizel ve turbo dizel motorlarda yüksek sıkıştırma oranlarından dolayı, conta malzemesi son derece önem taşımaktadır. Pistonlar motor bloğunun üstüne kadar geçer ve pistonlar daha düz ve subaplar pistonlarla sürtünmeyecek şekilde tasarlanmıştır. Bu sebepten ötürü conta kalınlıkları resimde görüldüğü gibi son derece önemlidir.

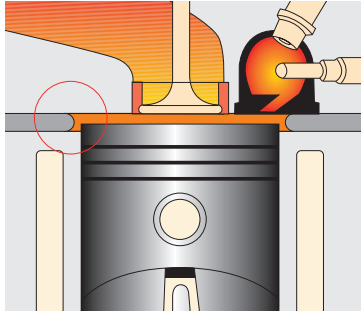

### Benzinli Araçlar:

Dizel araçlara göre sıkıştırma oranları ve torklar daha düşüktür. Fakat yine dizel araçlarda olduğu gibi basınca ve yüksek ısıya karşı sızdırmazlığı koruyacak malzemeler kullanılmalıdır. Günümüzde otomobil üreticileri sızdırmazlığı sağlamak amacıyla motorlarda Multi Layer Steel (MLS) contalar kullanmaktadır.

### Diesel and Turbo Diesel Vehicles :

Gasket material is of utmost importance in diesel and turbo diesel engines because of the high compressing ratios. Pistons pass beyond the engine block and pistons are designed as more flat and valves are designed in a way that they will not have friction with pistons. For this reason, as seen in the picture, gasket thicknesses are very important.

### Gasoline Vehicles :

Compression ratios and torques are less with respect to diesel vehicles. But still materials that will maintain sealing against compression must be used. Nowadays car drivers use Multi Layer Steel (MLS) gaskets in engines in order to provide sealing.

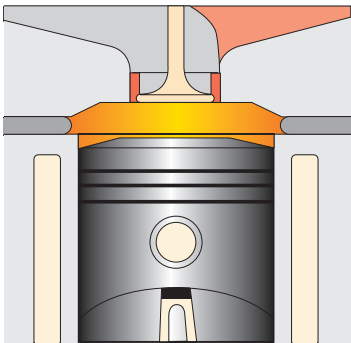

### **Multi Layer Steel (MLS) Kapak Contaları**

Birçok araç üreticisi artık orijinal donatım olarak Multi Layer Steel (çok katlı çelik) silindir kapak contalarını geliştirmiştir.

Bu ürünler, daha yüksek silindir basınçları ve modern motorlarda, ısı ve basınçla başa çıkabilmek amacıyla tasarlanmıştır. **COTECH**, gelişmiş tasarım sızdırmazlık materyalleri kullanarak, uygulamaları karşılayabilmek için en geniş Multi Layer Steel conta yelpazesini geliştirmiştir.

**COTECH** MLS Özel Kapak Contaları çelik üç katmandan oluşmaktadır. **COTECH**, basınca karşı doğal dayanımına ek güç olarak çelik kullanmaktadır.

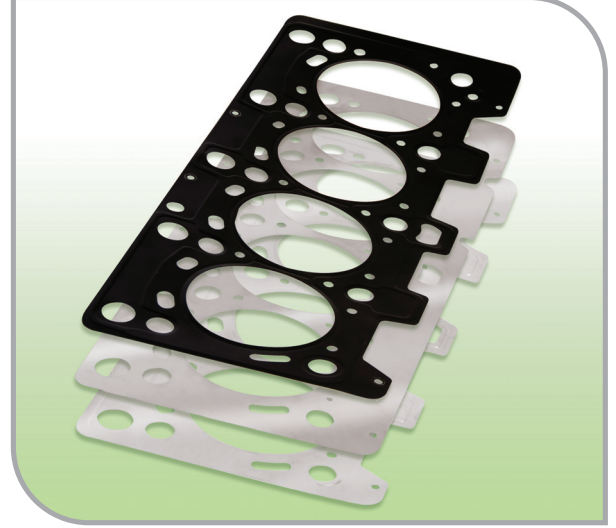

### **Multi Layer Steel (MLS) Head Gaskets.**

*Many vehicle manufacturers are now fitting Multi Layer steel cylinder head gaskets, as original equipment.*

*These are designed to cope with higher cylinder pressures and thermal stresses in modern engines. **COTECH** has developed the widest range of Multi Layer steel gaskets to meet the demand for European and Asiatic applications using the latest design sealing system.*

**COTECH** MLS Custom Head Gaskets are comprised of three layers of stainless steel. **COTECH** use stainless steel for added strength it's ability to rebound and it's natural resistance to corrosion.



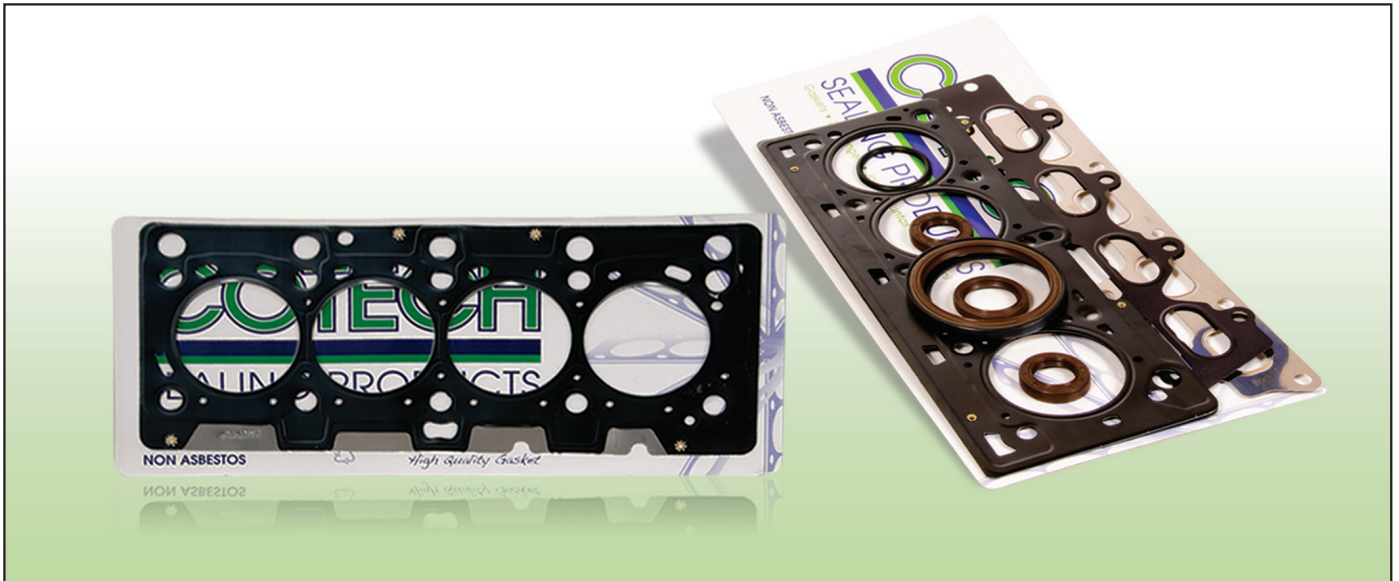





### **AMBALAJ / PACKAGE**



# KATALOG KULLANMA BİLGİLERİ

## INSTRUCTION FOR USE OF CATALOGUE

Kalınlık - Kertik - Delik  
Thick - Thickness - Hole - Notch

COTECH® SEALING PRODUCTS Gaskets • Dichtungen • Joints • Juntas • Guarnizioni		PEUGEOT			00	01	02	03	04	Silindir Kapak Cylinder Head Zylinderkopf Joint de culasse
Ltr	MODEL	PS/KW	ENGINE/MOTOR							
1,9 1905	4 CYL ø83 BOXER Bus D BOXER D EXPERT D J5 Bus D J5 D PARTNER D 306 D 306 SLD 405 D	03/88--> 70 PS / 51 KW 68 PS / 50 KW	XUD9A (DJY) XUD9A (D9B) XUD9AU (D8C)		61204002 0197.H5					61204009 0209.S5 1,36 mm 1  61204008 0209.S6 1,40 mm 2  61204007 0209.S7 1,44 mm 3  61204006 0209.S8 1,48 mm 4  61204005 0209.S9 1,53 mm 5  ø 84

▲ : İçerikte Bulunmamaktadır...

▲ : Not included in the set

▲ : Non inclus dans la pochette

00: Motor Takım Keçesiz ve Subap Lastiksiz

00: Gasket Set Without oil seals Without Valve Stem Seal

01: Motor Takım Keçesiz - Subap Lastikli

01: Gasket set With Valve Stem Seal Without Oil Seals











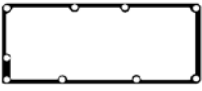
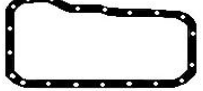





02: Motor Full Takım Keçeli ve Subap Lastikli

02: Gasket Full Set With oil seals and Valve Stem Seals

Sola Sarımlı  
Left-hand twist

Sağa Sarımlı  
Right-hand twist

Değişken Sarımlı  
Alternate twist

Subap Kapak Valve Cover Gasket Zylinderkopfhaube Couvre-culbut.	Karter Oil Pan Ölwanne Carter d'huile	Emme Manifold Intake Manifold Ansaug Admission	Egzoz Manifold Exhaust Manifold Auspuffkrümmer Collecteur D'echappement	Eksoz Boğaz Exhaust Pipe Auspuff Kehle	Supap Keçesi Valve Stem Seal Ventilschaft Queue de soupape	
						
 <b>61203525</b> 0249.46 0249.91	 <b>61203013</b> 0304.34  <b>61203014</b> 93501565	 <b>61203116x2</b> 0348.99  <b>61203018x2</b> 91508659	 <b>61205019</b> 1721.01 7810024000  <b>61203120x2</b> 0349.47 93010402	 <b>60107027x8</b> 0956.22 8x10,8/14,2x10	 <b>21201011x2</b> 35x50x8 <b>WD</b> <b>21201019</b> 42x62x8 <b>RD</b> <b>21201040</b> 90x110x7 <b>LD</b>	
		 <b>61203021</b> 0348.JO				

■ : Delik - Çentik

■ : Hole - Notch

■ : Trou - Entaille

NOT: Katalogdaki Orijinal Kodlar Referans Amacıyla Kullanılmıştır.Lütfen COTECH Kodlarını Kullanınız.  
Original codes used for reference only.Please use COTECH codes for orders.

**COTECH**<sup>®</sup>  
SEALING PRODUCTS

*çevre dostu  
üretim*

*green  
products*



## **İÇİNDEKİLER / İNDEX**

1- ALFA ROMEO	.....	1 - 2
2- ASIA MOTOR	.....	3 - 4
3- AUDI	.....	5 - 10
4- CHEVROLET	.....	11 - 14
5- CHRYSLER	.....	15 - 16
6- CITROEN	.....	17 - 32
7- DACIA	.....	33 - 36
8- DAEWOO	.....	37 - 42
9- DAIHATSU	.....	43 - 44
10- FIAT	.....	45 - 84
11- FORD	.....	85 - 96
12- HONDA	.....	97 - 98
13- HYUNDAI	.....	99 - 110
14- IVECO	.....	111 - 116
15- JOHN DEERE	.....	117 - 136
16- KIA	.....	137 - 148
17- LADA	.....	149 - 154
18- LAND ROVER	.....	155 - 156
19- MAHINDRA	.....	157 - 158
20- MAZDA	.....	159 - 170
21- MITSUBISHI	.....	171 - 176
22- NISSAN	.....	177 - 182
23- OPEL	.....	183 - 200
24- PEUGEOT	.....	201 - 228
25- PROTON	.....	229 - 232
26- RENAULT	.....	233 - 280
27- SAVIEM	.....	281 - 282
28- SKODA	.....	283 - 284
29- TOYOTA	.....	285 - 288
30- VOLVO	.....	289 - 300
31- VOLKSWAGEN	.....	301 - 314
32- VOLGA	.....	315 - 316

00



01



02



03



04



Silindir Kapak  
Cylinder Head  
Zylinderkopf  
Joint de culasse

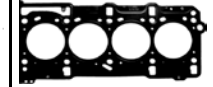

Ltr	MODEL	PS/KW	ENGINE/MOTOR		
1,8 1796	4 CYL ø80,5 159 03/07-->11/11	103 PS / 140 KW	939 A4.000		 <b>61417005</b> 71744395 1,20mm FIBER / FIBRE <b>ø82</b>
1,9 1910	4 CYL ø82 DIESEL 147 JTD 04/01--> 147 JTD 04/01--> 156 JTD 10/00-->05/01 156 JTD 05/01-->09/05	115 PS / 85 KW 101 PS / 74 KW 110 PS / 81 KW 115 PS / 85 KW	937 A2.000 182 B9.000 AR 37101 937 A2.000	<b>62427802</b> 60 816 452  <b>62427803</b> 71716051  <b>62427704</b> 71730213	 <b>62427805</b> 60816233 0,82mm <b>ø83</b> <b>62427806</b> 60816234 0,92mm 1 <b>M</b> <b>ø83</b> <b>62427807</b> 60816235 1,02mm 2 <b>M</b> <b>MLS</b> <b>ø83</b>
1,9 1929	4 CYL DIESEL ø82,6 145 TD 10/94-->02/99 146 TD 10/94-->02/99	90 PS / 66 KW 90 PS / 66 KW	AR 33601 AR 67501		 <b>62426605</b> 46451596 1,90mm <b>ø83,5</b>
2,00 1995	4 CYL ø84 164 TURBO (DOCH) 10/87-->09/98	174 PS / 128 KW	AR 06476	<b>62424001</b> 60777803	 <b>62424005</b> 7660966 1,80mm <b>ø85</b>

▲ : İçerikte Bulunmamaktadır...

▲ : Not included in the set

▲ : Non inclus dans la pochette

00: Motor Takım Keçesiz ve Subap Lastiksiz

00: Gasket Set Without oil seals Without Valve Stem Seal











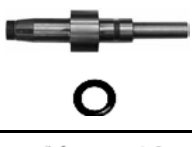
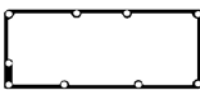

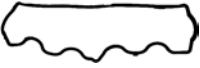

01: Motor Takım Keçesiz - Subap Lastikli

01: Gasket set With Valve Stem Seal Without Oil Seals

02: Motor Full Takım Keçeli ve Subap Lastikli

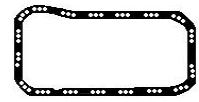
02: Gasket Full Set With oil seals and Valve Stem Seals

001

Subap Kapak Valve Cover Gasket Zylinderkopfhaube Couvre-culbut.	Karter Oil Pan Ölwanne Carter d'huile	Emme Manifold Intake Manifold Ansaug Admission	Egzoz Manifold Exhaust Manifold Auspuffkrümmer Collecteur D'echappement	Eksoz Boğaz Exhaust Pipe Auspuff Kehle	Supap Keçesi Valve Stem Seal Ventilschaft Queue de soupape	
						
						<b>21208003</b> 30x42x7 RD
<b>62427825</b> 55197598		<b>62427820</b> 71738458	<b>62427821</b> 46467747		<b>60107027x8</b> 60504110 8x10,8/14,2x10	<b>21201100</b> 31x41x7 RD
						
<b>60330034x2</b> 7660565	<b>62424013</b> 7646248	<b>60330019</b> 7700197	<b>60308020</b> 4368925		<b>60107027x8</b> 60504110 8x10,8/14,2x10	
						
<b>60331035x2</b> 7684064						

■ : Delik - Çentik

■ : Hole - Notch

■ : Trou - Entaille

NOT: Katalogdaki Orijinal Kodlar Referans Amacıyla Kullanılmıştır.Lütfen Cotech Kodlarını Kullanınız.  
Original codes used for reference only.Please use COTECH codes for orders.

00



Silindir Kapak

Cylinder Head

01



Zylinderkopf

02



Joint de culasse

03



04



Ltr	MODEL	PS/KW	ENGINE/MOTOR		
1,8 1781	<b>4 CYL ø86</b> ROCSTA 06/93-->12/99	77 PS / 57 KW	F804 FE		<p><b>61420305</b> F202-10-271 1,40mm <b>61420306</b> F202-10-271 1,80mm <b>ø87,5</b></p>
2,2 2184	<b>4 CYL ø86</b> ROCSTA 11/89 -->12/99 DIESEL 06/93-->12/99	72PS / 53KW 61PS / 45 KW	R2	<b>61410000</b> 8AG7-10-271	<p><b>61410005</b> R201-10-271A <b>ø87,5</b></p>
2,7 2701	<b>4 CYL ø92</b> HI-TOPIC 01/98-->12/99 TOPIC 06/93-->12/99 DIESEL	69 PS / 51 KW 75 PS / 55 KW		<b>61480000</b> AGS-T-725M	<p><b>61480005</b> 0527-10-271A <b>ø97</b></p>

▲ : İçerikte Bulunmamaktadır...

▲ : Not included in the set

▲ : Non inclus dans la pochette

00: Motor Takım Keçesiz ve Subap Lastiksiz











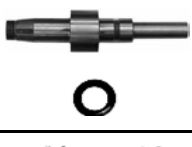
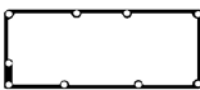



00: Gasket Set Without oil seals Without Valve Stem Seal

01: Motor Takım Keçesiz - Subap Lastikli

01: Gasket set With Valve Stem Seal Without Oil Seals

02: Motor Full Takım Keçeli ve Subap Lastikli

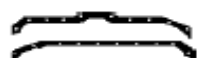
02: Gasket Full Set With oil seals and Valve Stem Seals

Subap Kapak Valve Cover Gasket Zylinderkopfhaube Couvre-culbut.	Karter Oil Pan Ölwanne Carter d'huile	Emme Manifold Intake Manifold Ansaug Admission	Egzoz Manifold Exhaust Manifold Auspuffkrümmer Collecteur D'echappement	Eksoz Boğaz Exhaust Pipe Auspuff Kehle	Supap Keçesi Valve Stem Seal Ventilschaft Queue de soupape	
						
						
61410025 RF01-10-235	61410013 F80110-431	61410019 RF0113-111	61410020 RF01-13-462			
						
61480025 1456-10-235	61480013 1363-89-104	61480019x4 0636-13-111	61480021x4 0750-13-461 0750-13-461A			

■ : Delik - Çentik

■ : Hole - Notch

■ : Trou - Entaille

NOT: Katalogdaki Orijinal Kodlar Referans Amacıyla Kullanılmıştır.Lütfen COTECH Kodlarını Kullanınız.  
Original codes used for reference only.Please use COTECH codes for orders.

00



Silindir Kapak  
Cylinder Head  
Zylinderkopf  
Joint de culasse

01



02



03



04



Ltr	MODEL	PS/KW	ENGINE/MOTOR		
1,4 1390	4 CYL ø76,5 A2 02/00-->08/05	75 PS / 55 KW	AUA BBY	61405303	 61405305 036 103 383 AL MLS ø77,5
1,6 1588	4 CYL ø79,5 80 80 COUPE 08/78-->07/86 09/73-->07/86	75 PS / 55 KW 100 PS / 74 KW 75 PS / 55 KW	WW WZ XX YG YH YN	61401002 049 198 001 C 61401003 049 198 012 H 61401004 037 198 011 C	 61401005 049 103 383 K 1,60mm ø81
1,6 1595	4 CYL ø79,5 80 80 8192242682->	110 PS / 81 KW 70 PS / 51 KW	YP YS YT YY YZ	61401002 049 198 001 C 61401003 049 198 012 H 61401004 037 198 011 C	 61401005 049 103 383 K 1,60mm ø81
1,6 1588	4 CYL ø79,5 80 8192242683->	110 PS / 81 KW 70 PS / 51 KW	YP YS YT YY YZ	61401002 049 198 001 C 61401003 049 198 012 H 61401004 037 198 011 C	 61401005 049 103 383 K 1,60mm ø81
1,6 1595	4 CYL ø81 80 08 /90-->10/91 09/91-->12/94 06/93-->01/96	102 PS / 75 KW 71 PS / 52 KW 101 PS / 74 KW	ABB ABM ADA DT JU RN PP RN		 61408005 026 103 383P 026 103 383L 026 103 383M 026 103 383N 026 103 383K 1,75mm ø83

▲ : İçerikte Bulunmamaktadır...

▲ : Not included in the set

▲ : Non inclus dans la pochette

00: Motor Takım Keçesiz ve Subap Lastiksiz

00: Gasket Set Without oil seals Without Valve Stem Seal











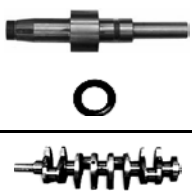
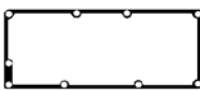











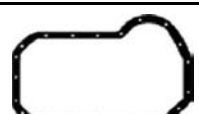

01: Motor Takım Keçesiz - Subap Lastikli

01: Gasket set With Valve Stem Seal Without Oil Seals

02: Motor Full Takım Keçeli ve Subap Lastikli

02: Gasket Full Set With oil seals and Valve Stem Seals

005

Subap Kapak Valve Cover Gasket Zylinderkopfhaube Couvre-culbut.	Karter Oil Pan Ölwanne Carter d'huile	Emme Manifold Intake Manifold Ansaug Admission	Egzoz Manifold Exhaust Manifold Auspuffkrümmer Collecteur D'echappement	Eksoz Boğaz Exhaust Pipe Auspuff Kehle	Supap Keçesi Valve Stem Seal Ventilschaft Queue de soupape	
						
62427465	62427465	61405319x4 036 129 717 E	61405321 036 253 039 F		62427426x16 036 109 675 A	21204029x2 27x42x8 RD
						21201075x3 32x47x10 W  21204504 85x105x12 LD
61401034 026 198 025 A	61401013 028 103 609 A	61401019 026 129 717 D	61401021x4 026 129 589 A 056 129 589 B	61408017 841 253 115 B	60107027x8 026 109 675 8x10,8/14,2x10	
						21201075x3 32x47x10 WD  21204504 85x105x12 LD
61401034 026 198 025 A	61401013 028 103 609 A	61401019 026 129 717 D	61401021x4 026 129 589 A 056 129 589 B	61408017 841 253 115 B	60107027x8 026 109 675 8x10,8/14,2x10	
						21201075x3 32x47x10 WD  21204504 85x105x12 LD
61401034 026 198 025 A	61401013 028 103 609 A	1401019 026 129 717 D	61401021x4 026 129 589 A 056 129 589 B	61408017 841 253 115 B	60107027x8 026 109 675 8x10,8/14,2x10	

■ : Delik - Çentik

■ : Hole - Notch

■ : Trou - Entaille

NOT: Katalogdaki Orijinal Kodlar Referans Amacıyla Kullanılmıştır.Lütfen COTECH Kodlarını Kullanınız.  
Original codes used for reference only.Please use COTECH codes for orders.

**AUDI**

00



Silindir Kapak

Cylinder Head

01



Zylinderkopf

02







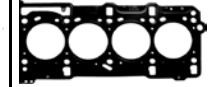

Joint de culasse

03



04



Ltr	MODEL	PS/KW	ENGINE/MOTOR		
1,6 1588	<b>4 CYL ø76,5</b> <b>DIESEL</b> <b>80</b> 08/80-->08/91  <b>TURBO DIESEL</b> <b>80 TD</b> 08/81-->08/91 <b>80 TD</b> 08/85-->09/91	55 PS / 40 KW  70 PS / 51 KW	JK  CY RA SB	<b>61402002</b> Motor Full Takım Gasket Full Set  <b>61402003</b> 068 198 012 L 068 198 012 E 033 198 012 A  <b>61402004</b> 037 198 011 C	 <b>61402005</b> 068 103 383 FN 1,60mm 3 ■  <b>61402006</b> 068 103 383 FM 1,50mm 2 ■  <b>61402007</b> 068 103 383 FL 1,40mm 1 ■ <b>ø78,5</b>   <b>61403005</b> 068 103 383 EK 1,61mm 3 ■  <b>61403006</b> 068 103 383 EJ 1,57mm 2 ■  <b>61403007</b> 068 103 383 EH 1,53mm 1 ■ <b>ø78,5</b>
1,8 1781	<b>4 CYL ø81</b> <b>AUDI COUPE</b> 08/81-->11/90 <b>100</b> 08/82-->10/91 <b>80</b> 08/84-->10/91 09/86-->08/90	90 PS / 66 KW 75 PS / 55KW 112 PS / 82 KW 110 PS / 81 KW 113 PS / 83 KW	DD DR DS JV JW NP SH 4B DZ JN PH PM PV RS MU NE SF SD		 <b>61408005</b> 026 103 383 P 026 103 383 L 026 103 383 M 026 103 383 N 026 103 383 K 1,75mm <b>ø83</b>

▲ : İçerikte Bulunmamaktadır...

▲ : Not included in the set

▲ : Non inclus dans la pochette

00: Motor Takım Keçesiz ve Subap Lastiksiz











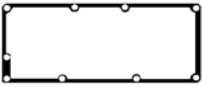
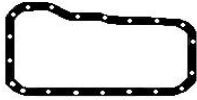

00: Gasket Set Without oil seals Without Valve Stem Seal

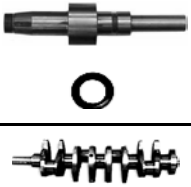
01: Motor Takım Keçesiz - Subap Lastikli

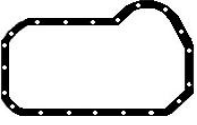
01: Gasket set With Valve Stem Seal Without Oil Seals

02: Motor Full Takım Keçeli ve Subap Lastikli

02: Gasket Full Set With oil seals and Valve Stem Seals

<p>Subap Kapak Valve Cover Gasket Zylinderkopfhaube Couvre-culbut.</p> 	<p>Karter Oil Pan Ölwanne Carter d'huile</p> 	<p>Emme Manifold Intake Manifold Ansaug Admission</p> 	<p>Egzoz Manifold Exhaust Manifold Auspuffkrümmer Collecteur D'echappement</p> 	<p>Eksoz Boğaz Exhaust Pipe Auspuff Kehle</p> 	<p>Supap Keçesi Valve Stem Seal Ventilschaft Queue de soupape</p> 	
 <p><b>61401034</b> 026 103 483 026 103 483 B 026 103 483 C 056 103 483 D</p>	 <p><b>61401013</b> 028 103 609 A 034 129 717 C</p>	 <p><b>61401019</b> 026 129 717D</p>  <p><b>61402019</b> 068 129 717 E</p>	 <p><b>61401021x4</b> 026 129 589 A 028 129 589 B</p>	 <p><b>61401017</b> 841 253 115 B</p>	 <p><b>60107027x8</b> 7553637 <b>8x10,8/14,2x10</b></p>	<p><b>21201075x3</b> 32x47x10 WD</p> <p><b>21204504</b> 85x105x12 LD</p>

■ : Delik - Çentik

■ : Hole - Notch

■ : Trou - Entaille

NOT: Katalogdaki Orijinal Kodlar Referans Amacıyla Kullanılmıştır.Lütfen COTECH Kodlarını Kullanınız.  
Original codes used for reference only.Please use COTECH codes for orders.

**AUDI**

00



01



02



03









04



Silindir Kapak  
Cylinder Head  
Zylinderkopf  
Joint de culasse



Ltr	MODEL	PS/KW	ENGINE/MOTOR		
1,9 1896	<b>4 CYL ø79,5</b> <b>80 D</b> 08/89-->08/91 <b>80 TD</b> 08/91-->12/94	68 PS / 50 KW 75 PS / 55 KW	1Y AAZ	<b>61405103</b> 028 198 012 B  <b>61405104</b> 028 198 011 D 	 <b>61405105</b> 028 103 383 BD 1,70mm 3 ■ <b>61405106</b> 028 103 383 BC 1,65mm 2 ■ <b>61405107</b> 028 103 383 BB 1,60mm 1 ■ <b>ø81</b>
1,9 1896	<b>4 CYL ø79,5</b> <b>AUDI A80 TDI</b> 09/91-->01/96 <b>A4 TDI</b> 01/95-->09/01 <b>A6 TDI</b> 06/94-->12/97 <b>CABRIO TDI</b> 06/95-->08/00	90 PS / 66 KW 110 PS / 81 KW 75 PS / 55 KW	1Z AHH AHU AFN AVG AFF	<b>61405203</b> 028 198 012 C  <b>61405104</b> 028 198 012 D 	 <b>61405205</b> 028 103 383 BR 028 103 383 BN 1,61mm 3 ■ <b>61405206</b> 028 103 383 BQ 028 103 383 BM 1,53mm 2 ■ <b>61405207</b> 028 103 383 BP 028 103 383 BL 1,45mm 1 ■ <b>MLS</b> <b>ø81</b>
2,0 1984	<b>4 CYL ø82,5mm</b> <b>AUDI COUPE</b> 05/89-->12/96 <b>100</b> 12/90-->06/94 <b>80</b> 01/93-->09/98 <b>CABRIOLET</b> 01/91--> 07/95 <b>16 VALVE</b>	112 PS / 82 KW 100 PS / 74 KW 115 PS / 82 KW 115 PS / 85 KW	AAD AAE ABK ABT ADW SD 3A		 <b>61408105</b> 048 103 383 B 1,75mm <b>ø83,5</b>

▲ : İçerikte Bulunmamaktadır...

▲ : Not included in the set

▲ : Non inclus dans la pochette

00: Motor Takım Keçesiz ve Subap Lastiksiz











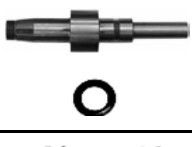
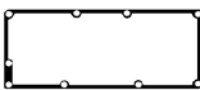

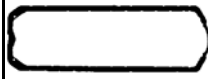

00: Gasket Set Without oil seals Without Valve Stem Seal

01: Motor Takım Keçesiz - Subap Lastikli

01: Gasket set With Valve Stem Seal Without Oil Seals

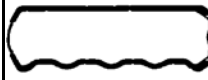
02: Motor Full Takım Keçeli ve Subap Lastikli

02: Gasket Full Set With oil seals and Valve Stem Seals

Subap Kapak Valve Cover Gasket Zylinderkopfhaube Couvre-culbut.	Karter Oil Pan Ölwanne Carter d'huile	Emme Manifold Intake Manifold Ansaug Admission	Egzoz Manifold Exhaust Manifold Auspuffkrümmer Collecteur D'echappement	Eksoz Boğaz Exhaust Pipe Auspuff Kehle	Supap Keçesi Valve Stem Seal Ventilschaft Queue de soupape	
						
						<b>21208042</b> 32x47x10 WD
<b>61405125</b> 028 103 483 F 028 103 483 H  028 103 532 A x3		<b>61405121</b> 028 129 717 D	<b>61401021x4</b> 026 129 589 A 028 129 589 B		<b>60107027x8</b> 7553637 <b>8x10,8/14,2x10</b>	<b>21204504</b> 85x105x12 LD  <b>21208042x2</b> 32x47x10 WD
						<b>21208042</b> 32x47x10 WD
<b>61405225</b> 028 103 483 C 028 103 483 G  028 103 532 A x3	<b>61401014</b> 044 103 609 D	<b>61405121</b> 028 129 717 D	<b>61401021x4</b> 026 129 589 A 028 129 589 B		<b>60107027x8</b> 7553637 <b>8x10,8/14,2x10</b>	<b>21204504</b> 85x105x12 LD  <b>21208042x2</b> 32x47x10 WD

■ : Delik - Çentik

■ : Hole - Notch

■ : Trou - Entaille

NOT: Katalogdaki Orijinal Kodlar Referans Amacıyla Kullanılmıştır.Lütfen COTECH Kodlarını Kullanınız.  
Original codes used for reference only.Please use COTECH codes for orders.

00



Silindir Kapak

Cylinder Head

01



Zylinderkopf

02



Joint de culasse

03



04



Ltr	MODEL	PS/KW	ENGINE/MOTOR		
0,8 796	<b>3 CYL ø68,5</b> MATIZ SPARK 03/05-->	52 PS / 38 KW 50 PS / 30 KW	F8CV		<p><b>61460105</b> 11141A78B01-00 1,30mm ø69,5</p>
1,4 1393	<b>4 CYL ø82</b> CHEVETTE 1976-->1977	85 PS / 45 KW	85		<p><b>61415205</b> 1,20mm ø83</p>
1,4 1393	<b>4 CYL ø77,9</b> AVEO (SOHC )	83 PS / 61KW	F14S3		<p><b>62447305</b> 5607408 1,40mm ø80,5</p>
1,4 1399	<b>4 CYL ø77,9</b> AVEO LACETTI NUBIRA OPTRA KALOS (DOCH 16 V ) 03/05-->01/09	94 PS / 69 KW	F14D3		<p><b>62450105</b> 96473400 1,20mm FIBER / FIBRE ø80</p>
1,6 1598	<b>4 CYL ø79</b> AVEO KALOS NUBIRA OPTRA LACETTI CRUZE ( DOCH16V ) 2003 -->2005	109 PS / 80 KW	F16D3 F16D4 A16DMS		<p><b>62450205</b> 96378802 1,20mm FIBER / FIBRE ø80</p>
1,6 1599	<b>4 CYL ø82</b> CHEVETTE 1976-->1987	85 PS / 45 KW	98		<p><b>61415205</b> 1,20mm ø83</p>

▲ : İçerikte Bulunmamaktadır...

▲ : Not included in the set

▲ : Non inclus dans la pochette

00: Motor Takım Keçesiz ve Subap Lastiksiz

00: Gasket Set Without oil seals Without Valve Stem Seal

01: Motor Takım Keçesiz - Subap Lastikli

01: Gasket set With Valve Stem Seal Without Oil Seals

02: Motor Full Takım Keçeli ve Subap Lastikli

02: Gasket Full Set With oil seals and Valve Stem Seals



00



Silindir Kapak  
Cylinder Head

01



Zylinderkopf

02



Joint de culasse

03



04



Ltr	MODEL	PS/KW	ENGINE/MOTOR		
1,6 1598	<b>4 CYL ø77,9</b> AVEO LACETTI NUBIRA OPTRA KALOS (DOCH 16 V)	03/05-->01/09 94 PS / 69 KW	F16D3		<p><b>62450105</b> 96473400 1,20mm FIBER / FIBRE ø80</p>
2,0 1998	<b>4 CYL ø86</b> VIVANT EPICA REZZO TACUMA EVANDA (DOCH 16 V)	2000-->2007 2003 01/05-->12/06 09/2000 08/02-->2006 122 PS / 89 KW 131 PS / 96 KW	T20SED X20SED		<p><b>62447605</b> 5607449 1,40mm ø87,5</p>

▲ : İçerikte Bulunmamaktadır...

▲ : Not included in the set

▲ : Non inclus dans la pochette

00: Motor Takım Keçesiz ve Subap Lastiksiz







00: Gasket Set Without oil seals Without Valve Stem Seal

01: Motor Takım Keçesiz - Subap Lastikli

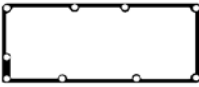
01: Gasket set With Valve Stem Seal Without Oil Seals

02: Motor Full Takım Keçeli ve Subap Lastikli

02: Gasket Full Set With oil seals and Valve Stem Seals

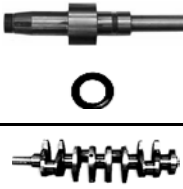
<p>Subap Kapak Valve Cover Gasket Zylinderkopfhaube Couvre-culbut.</p> 	<p>Karter Oil Pan Ölwanne Carter d'huile</p> 	<p>Emme Manifold Intake Manifold Ansaug Admission</p> 	<p>Egzoz Manifold Exhaust Manifold Auspuffkrümmer Collecteur D'echappement</p> 	<p>Eksoz Boğaz Exhaust Pipe Auspuff Kehle</p> 	<p>Supap Keçesi Valve Stem Seal Ventilschaft Queue de soupape</p> 	

■ : Delik - Çentik

■ : Hole - Notch

■ : Trou - Entaille

NOT: Katalogdaki Orijinal Kodlar Referans Amacıyla Kullanılmıştır.Lütfen COTECH Kodlarını Kullanınız.  
Original codes used for reference only.Please use COTECH codes for orders.

00



Silindir Kapak

Cylinder Head

01



Zylinderkopf

02



Joint de culasse

03



04



Ltr	MODEL	PS/KW	ENGINE/MOTOR		
1,5 1468	4 CYL ø75,5 COLT PREMIER ( SOCH )	84 PS / 63 KW	G15B		<p><b>61500305</b> MD016163 1,40mm</p> <p><b>61500306</b> MD016163 2,00mm ø76,5</p>
1,5 1468	4 CYL ø75,5 COLT 12V ( SOCH )	90 PS / 66 KW	4G15		<p><b>61415405</b> MD323473 1,40mm ø76,5</p>
2,3 2346	4 CYL ø91 PICK-UP RAM 50 TD PICK-UP POWER RAM 50 TD ( SOCH ) 1983-->1985	68 PS / 50 KW	4D55T	<p><b>61450001</b> MD050092</p> <p><b>61450002</b> MD050092</p>	<p><b>61450005</b> MD050545 1,80mm</p> <p>ø92,5</p>

▲ : İçerikte Bulunmamaktadır...

▲ : Not included in the set

▲ : Non inclus dans la pochette

00: Motor Takım Keçesiz ve Subap Lastiksiz









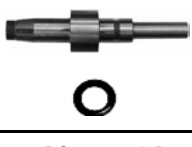
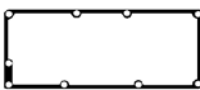

00: Gasket Set Without oil seals Without Valve Stem Seal

01: Motor Takım Keçesiz - Subap Lastikli

01: Gasket set With Valve Stem Seal Without Oil Seals

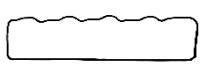
02: Motor Full Takım Keçeli ve Subap Lastikli

02: Gasket Full Set With oil seals and Valve Stem Seals

Subap Kapak Valve Cover Gasket Zylinderkopfhaube Couvre-culbut.	Karter Oil Pan Ölwanne Carter d'huile	Emme Manifold Intake Manifold Ansaug Admission	Egzoz Manifold Exhaust Manifold Auspuffkrümmer Collecteur D'echappement	Eksoz Boğaz Exhaust Pipe Auspuff Kehle	Supap Keçesi Valve Stem Seal Ventilschaft Queue de soupape	
						
						<b>21201013</b> 35x50x8 RD
<b>61450025</b> MD050312	<b>61450013</b> MD149392	<b>61450021</b> MD050482			<b>61450026x8</b> 8x13x9x13	<b>21201023</b> 44x60x7 RD
						<b>21201035</b> 80x96x9 LD
						<b>21201004</b> 25x35x6
						<b>21201001</b> 17x28x7

■ : Delik - Çentik

■ : Hole - Notch

■ : Trou - Entaille

NOT: Katalogdaki Orijinal Kodlar Referans Amacıyla Kullanılmıştır.Lütfen COTECH Kodlarını Kullanınız.  
Original codes used for reference only.Please use COTECH codes for orders.

00



01



02



03



04



Silindir Kapak  
Cylinder Head  
Zylinderkopf  
Joint de culasse

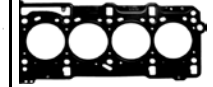

Ltr	MODEL	PS/KW	ENGINE/MOTOR		
1,0 954	4 CYL ø70 LNA 10 07/84->10 /86 VISA 10 C 15	45 PS / 33 KW	108C	61216002 198,57	 61216005 0203.84 1,20mm Loc ø16mm 61216006 0203.22 1,40mm ø74
1,0 954	4 CYL ø70 AX10 07/86-->12/98 AX10 07/92->12/98 AX10 07/92->12/98 C15E 10/84->12/97 SAXO 05/98-> SAXO 1996-> SAXO 05/1996->	45PS / 33KW 50PS / 37KW 50PS / 37KW 45PS / 33KW 45PS / 33KW 45PS / 33KW 45PS / 33KW	C1A (TU9) CDZ (TU9M) CDY (TU9M) C1A (TU9) CDY (TU9L) C1A (TU9M) CDZ (TU9L)	61221002 Motor Full Takım Gasket Full Set 61221003 0197.H8+0209.89 61209004 0197.H9	 61221005 0209.89 1,30mm 1 61221006 0209.90 1,50mm 2 ø73,5
1,1 1124	4 CYL ø72 BERLINGO 07/96-> SAXO 05/96-> ZX 07/96->08/97 INJECTION	60PS / 44KW 60PS / 44KW 60PS / 44KW	HDY (TU1M+) HDZ(TU1M+) TU1M+	61221002 Motor Full Takım Gasket Full Set 61221003 0197.H8+0209.89 61209004 0197.H9	 61221005 0209.89 1,30mm 1 61221006 0209.90 1,50mm 2 ø73,5
1,1 1124	4 CYL ø72 AX 11 1986->1997 AX 11 4x4 06/94->07/92 BX 11 10/86->06/92 C15 E 07/88->12/96 ZX 07/91->06/95	55PS / 40KW 55PS / 40KW 55PS / 40KW 55PS / 40KW 55PS / 40KW 55PS / 40KW	H1B (TU1CLC ) HDZ (TU1M ) H1A (TU1 ) H1A (TU1 ) H1A (TU1 ) TU1MZ	61209002 Motor Full Takım Gasket Full Set 61209003 0197.H8+0209.CJ 61209004 0197.H9	 61209005 0209.CJ 1,30mm 1 61209006 0209.W6 - W7 1,50 mm 2 ø76

▲ : İçerikte Bulunmamaktadır...

▲ : Not included in the set

▲ : Non inclus dans la pochette

00: Motor Takım Keçesiz ve Subap Lastiksiz











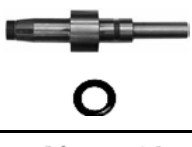
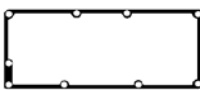





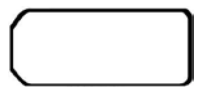





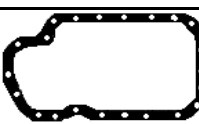

00: Gasket Set Without oil seals Without Valve Stem Seal

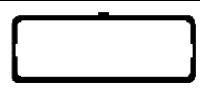
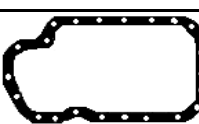
01: Motor Takım Keçesiz - Subap Lastikli

01: Gasket set With Valve Stem Seal Without Oil Seals

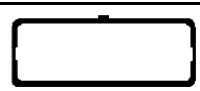
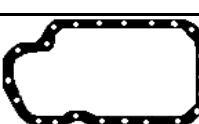
02: Motor Full Takım Keçeli ve Subap Lastikli

02: Gasket Full Set With oil seals and Valve Stem Seals

Subap Kapak Valve Cover Gasket Zylinderkopfhaube Couvre-culbut.	Karter Oil Pan Ölwanne Carter d'huile	Emme Manifold Intake Manifold Ansaug Admission	Egzoz Manifold Exhaust Manifold Auspuffkrümmer Collecteur D'echappement	Eksoz Boğaz Exhaust Pipe Auspuff Kehle	Supap Keçesi Valve Stem Seal Ventilschaft Queue de soupape	
						
 61201525 0249.39	 61201013 0304.46	 61201018 0384.54	 61201020 0349.16	 61205017 7700657683	 60107027x8 956,22 8x10.8/14.2x10	21201013 35x50x8 WD  21201033 78x100x10 LD
 61209025 0249.54	 61209013 0304.304	 61209019x2	 61209020x2 0349,A6	 61209017 1709.15	 60116026x8 0956.19 7x9,8/13.2x10	21201062 36x50x7 RD  21201021 42x66x6 RD  21204504 85x105x8 LD
 61209025 0249.54	 61209013 0304.304	 61209019x2	 61209020x2 0349,A6	 61209017 1709.15	 60116026x8 0956.19 7x9,8/13.2x10	21201062 36x50x7 RD  21201021 42x66x6 RD  21204504 85x105x8 LD
 61209025 0249.54	 61209013 0304.304	 61209019x2	 61209020x2 0349,A6	 61209017 1709.15	 60116026x8 0956.19 7x9,8/13.2x10	21201062 36x50x7 RD  21201021 42x66x6 RD  21204504 85x105x8 LD

■ : Delik - Çentik

■ : Hole - Notch

■ : Trou - Entaille

NOT: Katalogdaki Orjinal Kodlar Referans Amacıyla Kullanılmıştır.Lütfen COTECH Kodlarını Kullanınız.  
Original codes used for reference only.Please use COTECH codes for orders.

00



Silindir Kapak  
Cylinder Head

01



Zylinderkopf

02



Joint de culasse

03



04

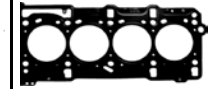

Ltr	MODEL	PS/KW	ENGINE/MOTOR			
1,1 1124	<b>4 CYL ø72</b> BERLINGO C2 C3 SAXO	07/96--> 09/03--> 02/02--> 05/96-->	60PS / 44 KW	HFX ( TU1JP )		<p><b>61222005</b> 0209.Y0 1,30mm 1 </p> <p><b>61222006</b> 0209.Y1 1,50mm 2 </p> <p><b>ø74</b></p>
1,1 1118	<b>4 CYL ø74</b> C15 E	10/84->10/96	48PS / 35KW	E1A (E1)		<p><b>61208005</b> 0209.H9 1,20mm <b>ø77</b></p>
1,3 1294	<b>4 CYL ø75</b> AX 13 SPORT	04/87-->12/88	95PS / 70KW	M4A	<p><b>61209002</b> Motor Full Takım Gasket Full Set</p> <p><b>61209003</b> 0197.H8+0209.CJ</p> <p><b>61209004</b> 0197.H9</p>	<p><b>61209005</b> 0209.CJ 1,30mm 1 </p> <p><b>61209006</b> 0209.W6 - W7 1,50 mm 2 </p> <p><b>ø76</b></p>
1,4 1360	<b>4 CYL ø75</b> VISA GT BX 14 C15 VISA	07/82-->04/85 04/83-->02/93	72PS / 53KW 67PS / 49 KW 75PS / 55 KW	150A 150B 150C 150D 150F	<p><b>61201002</b> 0197.77</p>	<p><b>61201005</b> 0209.A6 1,30mm Loc 14mm <b>ø76</b></p>
1,4 1360	<b>4 CYL ø75</b> C2 C3 C4 16 V	06/06--> 12/03--> 11/04-->	88PS / 65KW	KFU (ET3J4)		<p><b>62190005</b> 0209.CH 0209.FL 1,40mm <b>ø76</b></p>

▲ : İçerikte Bulunmamaktadır...

▲ : Not included in the set

▲ : Non inclus dans la pochette

00: Motor Takım Keçesiz ve Subap Lastiksiz











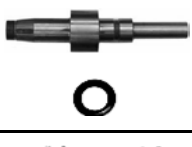
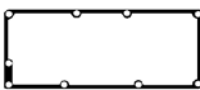







00: Gasket Set Without oil seals Without Valve Stem Seal

01: Motor Takım Keçesiz - Subap Lastikli

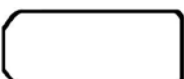
01: Gasket set With Valve Stem Seal Without Oil Seals

02: Motor Full Takım Keçeli ve Subap Lastikli

02: Gasket Full Set With oil seals and Valve Stem Seals

Subap Kapak Valve Cover Gasket Zylinderkopfhaube Couvre-culbut.	Karter Oil Pan Ölwanne Carter d'huile	Emme Manifold Intake Manifold Ansaug Admission	Egzoz Manifold Exhaust Manifold Auspuffkrümmer Collecteur D'echappement	Eksoz Boğaz Exhaust Pipe Auspuff Kehle	Supap Keçesi Valve Stem Seal Ventilschaft Queue de soupape	
						
						<b>21201062</b> 36x50x7 RD
<b>61209025</b> 0249.54	<b>61209013</b> 0304.304	<b>61209019x2</b>	<b>61209020x2</b> 0349,A6	<b>61209017</b> 1709.15	<b>60116026x8</b> 0956.19 7x9,8/13.2x10	<b>21201021</b> 42x66x6 RD
						<b>21204504</b> 85x105x8 LD
						<b>21201013</b> 35x50x8 WD
<b>61201525</b> 0249.39	<b>61201013</b> 0304.46	<b>61201018</b> 0384.54	<b>61201020</b> 0349.16	<b>61205017</b> 7700657683	<b>60107027x8</b> 956,22 8x10.8/14.2x10	<b>21201033</b> 78x100x10 LD

■ : Delik - Çentik

■ : Hole - Notch

■ : Trou - Entaille

NOT: Katalogdaki Orijinal Kodlar Referans Amacıyla Kullanılmıştır.Lütfen COTECH Kodlarını Kullanınız.  
Original codes used for reference only.Please use COTECH codes for orders.

00



01



02



03









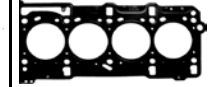

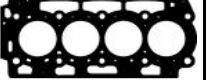

04



Silindir Kapak  
Cylinder Head  
Zylinderkopf  
Joint de culasse



Ltr	MODEL	PS/KW	ENGINE/MOTOR		
1,4 1398	<b>4 CYL ø74</b> C1 HDI 06/05--> C2 HDI 09/03--> C3 HDI 02/02--> C3 Pluriel HDI 04/04--> XSARA HDI 01/03-->08/05 Nemo HDI 02/08-->	68PS / 50KW 54PS / 40KW	DV4D DV4TD 8HX(DV4TD)	<b>61706002</b> Motor Full Takım Gasket Full Set  <b>61706003</b> Motor Üst Takım Gasket Head Set  <b>61706004</b> Motor Alt Takım Conversion Set	 <b>61706005</b> 0209.AH 1,45mm 5  <b>61706006</b> 0209.AG 1,40mm 4  <b>61706007</b> 0209.AE 1,30mm 3  <b>61706008</b> 0209.AC 1,25mm 2  <b>61706009</b> 0209.AF 1,35mm 1  MLS ø75
1,4 1360	<b>4 CYL ø75</b> BERLINGO 03/91--> SAXO VTS XSARA ZX C2 02/02--> C3 C3 Pluriel AX 04/83-->10/97 AX 14 BX 14 C15 ZX	75PS / 55KW 73PS / 53KW 85PS / 62 KW 54PS / 40 KW	KFW (TU3JP) KFX (TU3JP) TU3JP KFV (TU3JP) KAY (TU3CP) KAZ KDX (TU3M/Z) KDY (TU3FM) KDY (TU3M) K1B K1F K1G K1H (TU3A) K2A K2B K2D K3A	<b>61209002</b> Motor Full Takım Gasket Full Set <b>61209003</b> 0197.H8+0209.CJ <b>61209004</b> 0197.H9	 <b>61209005</b> 0209.CJ 1,30mm 1  <b>61209006</b> 0209.W6 - W7 1,50 mm 2  ø76

▲ : İçerikte Bulunmamaktadır...

▲ : Not included in the set

▲ : Non inclus dans la pochette

00: Motor Takım Keçesiz ve Subap Lastiksiz











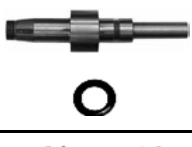
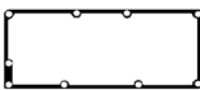





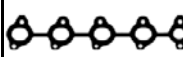

00: Gasket Set Without oil seals Without Valve Stem Seal

01: Motor Takım Keçesiz - Subap Lastikli

01: Gasket set With Valve Stem Seal Without Oil Seals

02: Motor Full Takım Keçeli ve Subap Lastikli

02: Gasket Full Set With oil seals and Valve Stem Seals

Subap Kapak Valve Cover Gasket Zylinderkopfhaube Couvre-culbut.	Karter Oil Pan Ölwanne Carter d'huile	Emme Manifold Intake Manifold Ansaug Admission	Egzoz Manifold Exhaust Manifold Auspuffkrümmer Collecteur D'echappement	Eksoz Boğaz Exhaust Pipe Auspuff Kehle	Supap Keçesi Valve Stem Seal Ventilschaft Queue de soupape	
						
						<b>21204017</b> 27x47x7 RD
<b>61706025</b> 0249.C1 0249.F8 1 148 101	<b>62427465</b>	<b>61706019x4</b> 0348.R2 0348.T8	<b>61706020</b> 0349.J8 0349.J7		<b>61706027x8</b> 0956.50 5,5x9,5x22,9x17,5	<b>21204018</b> 40x55x6,4 LD <b>21204019</b> 85x105x8,8 RD
						<b>21201062</b> 36x50x7 RD
<b>61209025</b> 0249.54	<b>61209013</b> 0304.304	<b>61209019x2</b>	<b>61209020x2</b> 0349,A6	<b>61209017</b> 1709.15	<b>60116026x8</b> 0956.19 7x9,8/13.2x10	<b>21201021</b> 42x66x6 RD <b>21204504</b> 85x105x8 LD

■ : Delik - Çentik

■ : Hole - Notch

■ : Trou - Entaille

NOT: Katalogdaki Orijinal Kodlar Referans Amacıyla Kullanılmıştır.Lütfen COTECH Kodlarını Kullanınız.  
Original codes used for reference only.Please use COTECH codes for orders.

00  
01  
02  
03  
04



Silindir Kapak  
Cylinder Head  
Zylinderkopf  
Joint de culasse

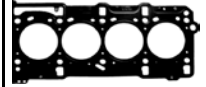

Ltr	MODEL	PS/KW	ENGINE/MOTOR		
1,4 1360	4 CYL ø75 AX AX 14 BX14 C 15 ZX 09/1986-->06/1997	85PS / 62 KW 55PS / 40KW	KDZ (TU3M/Z) KAY (TU3CP) K1B K1F K1G K1H (TU3A) K2A K2B K3A	61209002 Motor Full Takım Gasket Full Set 61209003 0197.H8+0209.CJ 61209004 0197.H9	 61209005 0209.CJ 1,30mm 1 61209006 0209.W6 - W7 1,50 mm 2 ø76
1,6 1560	4 CYL ø75 BERLINGO HDI BERLINGO HDI 75 BERLINGO HDI 90 C2 HDI C3 HDI C3 HDI 16V C4 C4 HDI C4 HDI 110 FAP C4 HDI 90 C5 HDI XSARA PICASSO HDI 05/04--> 11/04-->	109PS / 80 KW 90PS / 66 KW	DV6ATED4 DV6B DV6TED4 9HT (DV6BTED4) 9HT (DV6BUTED4) 9HX (DV6ATED4) 9HY (DV6TED4) 9HZ (DV6TED4)	61707002 Motor Full Takım Gasket Full Set 61707003 Motor Üst Takım Gasket Head Set 61707004 Motor Alt Takım Conversion Set	 61707005 0209.CG 1,45mm 5 61707006 0209.CF 1,40mm 4 61707007 0209.CC 1,30mm 3 61707008 0209.CA 1,25mm 2 61707009 0209.CE 1,35mm 1 MLS ø76
1,6 1587	4 CYL ø78,5 BERLINGO BERLINGO 16V C2 C3 Pluriel C3 16V C4 C4 16V XSARA PICASSO 16V XSARA 16V C2 VTS 09/00--> 01/05-->	110PS / 81KW 90PS / 66 KW 122PS / 90 KW	NFR (TU5JP4B) NFU (TU5JP4) NFS (TU5JP4S)		 62200005 0209.1E MLS ø79,5

▲ : İçerikte Bulunmamaktadır...

▲ : Not included in the set

▲ : Non inclus dans la pochette

00: Motor Takım Keçesiz ve Subap Lastiksiz











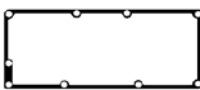







00: Gasket Set Without oil seals Without Valve Stem Seal

01: Motor Takım Keçesiz - Subap Lastikli

01: Gasket set With Valve Stem Seal Without Oil Seals

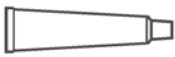
02: Motor Full Takım Keçeli ve Subap Lastikli

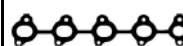
02: Gasket Full Set With oil seals and Valve Stem Seals

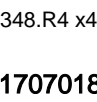
Subap Kapak Valve Cover Gasket Zylinderkopfhaube Couvre-culbut.	Karter Oil Pan Ölwanne Carter d'huile	Emme Manifold Intake Manifold Ansaug Admission	Egzoz Manifold Exhaust Manifold Auspuffkrümmer Collecteur D'echappement	Eksoz Boğaz Exhaust Pipe Auspuff Kehle	Supap Keçesi Valve Stem Seal Ventilschaft Queue de soupape	
						
						<b>21201062</b> 36x50x7 RD
<b>61209025</b> 0249.54	<b>61209013</b> 0304.304	<b>61209019x2</b>	<b>61209020x2</b> 0349,A6	<b>61209017</b> 1709.15	<b>60116026x8</b> 0956.19 7x9,8/13.2x10	<b>21201021</b> 42x66x6 RD
						<b>21204504</b> 85x105x8 LD
						<b>21204017</b> 27x47x7 RD
<b>61707025</b> 0249.C2	<b>62427465</b>		<b>61706021</b> 0349.J8 0349.J7 0349.N0 1 148 115		<b>61707026x16</b> 0956.51 5,5x9,5x18,1x14	<b>21204018</b> 40x55x6,4 LD
						<b>21204019</b> 85x105x8,8 RD
		<b>61707018</b> 0348.R5+0348.R4				

■ : Delik - Çentik

■ : Hole - Notch

■ : Trou - Entaille

NOT: Katalogdaki Orijinal Kodlar Referans Amacıyla Kullanılmıştır.Lütfen COTECH Kodlarını Kullanınız.  
Original codes used for reference only.Please use COTECH codes for orders.

00



01



02



03



04



Silindir Kapak  
Cylinder Head  
Zylinderkopf  
Joint de culasse

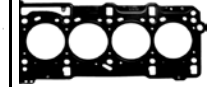

Ltr	MODEL	PS/KW	ENGINE/MOTOR			
1,6 1580	<b>4 CYL ø83</b> BX BX16 ZX VISA 16 GTI	10/82-->12/94 01/87-->10/97	88 PS / 65 KW 72 PS / 53 KW 116 PS / 85 KW 87 PS / 64 KW	BAY (XU5CP) BAZ (XU5CP) BDY (XU5M) BDZ (XU5M) B1A (XU51C/K) B1E (XU51C) B6D XU52C 171A 171B 171C 171D 180Z	<b>61207002</b> 0197.89+0209.E1  <b>61207003</b> 0197.H6+0209.E1  <b>62130002</b> 0197.89+0209.L3  <b>62130003</b> 0197.H6+0209.L3	 <b>61207005</b> 0209.E1 1,30mm 1  <b>61207006</b> 0209.L8 1,50mm 2  <b>62130005</b> 0209.L3 1,50mm  <b>ø84,5</b>
1,6 1580	<b>4 CYL ø83</b> XANTIA ZX	03/91-->01/98	88 PS / 65 KW	BFZ (XU5JP)	<b>61233002</b> 0197.G4+0209.E1	 <b>61207005</b> 0209.E1 1,30mm 1  <b>61207006</b> 0209.L8 1,50mm 2  <b>ø84,5</b>
1,8 1769	<b>4 CYL ø80</b> BERLINGO D BX 18 D C15 D VISA 17 D XSARA D ZX D	04/84-->	60 PS / 44 KW 58 PS / 43 KW	A9A (XUD7) 161 (XUD7) 161A (XUD7)	<b>61204002</b> 0197.H5   <b>61204003</b> 0197.H4 	 <b>61203009</b> 0209.S0 1,36 mm. 1 <b>61203008</b> 0209.S1 1,40 mm. 2 <b>61203007</b> 0209.S2 1,44 mm. 3 <b>61203006</b> 0209.S3 1,48 mm. 4 <b>61203005</b> 0209.S4 1,53 mm. 5  <b>ø82</b>

▲ : İçerikte Bulunmamaktadır...

▲ : Not included in the set

▲ : Non inclus dans la pochette

00: Motor Takım Keçesiz ve Subap Lastiksiz











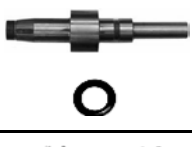
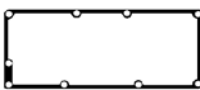













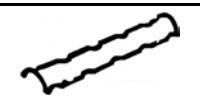
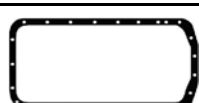

00: Gasket Set Without oil seals Without Valve Stem Seal

01: Motor Takım Keçesiz - Subap Lastikli

01: Gasket set With Valve Stem Seal Without Oil Seals

02: Motor Full Takım Keçeli ve Subap Lastikli

02: Gasket Full Set With oil seals and Valve Stem Seals

Subap Kapak Valve Cover Gasket Zylinderkopfhaube Couvre-culbut.	Karter Oil Pan Ölwanne Carter d'huile	Emme Manifold Intake Manifold Ansaug Admission	Egzoz Manifold Exhaust Manifold Auspuffkrümmer Collecteur D'echappement	Eksoz Boğaz Exhaust Pipe Auspuff Kehle	Supap Keçesi Valve Stem Seal Ventilschaft Queue de soupape	
						
 <b>61207525</b> 0249.48 91508054	 <b>61203013</b> 0304.34 93502226  <b>61203014</b> 93501565	 <b>61203018x2</b> 91508659. BX->1984  <b>61207018</b> 951299280  <b>61207019</b> 0348.76	 <b>61207020x4</b> 0349.70 91505500  <b>61205019</b> 1721.01 7810024000	 <b>61207017</b> 1710.39 91511460	 <b>60107027x8</b> 0956.22 8x10,8/14,2x10	<b>21201062</b> 36x50x7 RD <b>21201019</b> 42x62x8 RD <b>21201040</b> 90x110x10 LD
 <b>61233025</b> 0249.71	 <b>61203013</b> 0304.34 93502226.	 <b>61233018x4</b> 0348.E6 + 0348F6	 <b>61233020x4</b> 1723.63		 <b>60107027x8</b> 0956.22 8x10,8/14,2x10	<b>21201062</b> 36x50x7 RD <b>21201019</b> 42x62x8 RD <b>21201040</b> 90x110x10 LD
 <b>61203525</b> 0249.46 0249.91 93501444	 <b>61203013</b> 0304.34 93502226.  <b>61203014</b> 93501565	 <b>61203020x2</b> 9456044080  <b>61203018</b> 9456043980	 <b>61205019</b> 1721.01 7810024000  <b>61203120x2</b> 0349.78		 <b>60107027x8</b> 0956.22 8x10,8/14,2x10	<b>21201062</b> 36x50x7 RD <b>21201019</b> 42x62x8 RD <b>21201040</b> 90x110x10 LD

■ : Delik - Çentik

■ : Hole - Notch

■ : Trou - Entaille

NOT: Katalogdaki Orjinal Kodlar Referans Amacıyla Kullanılmıştır.Lütfen COTECH Kodlarını Kullanınız.  
Original codes used for reference only.Please use COTECH codes for orders.

00



01



02



03



04



Silindir Kapak  
Cylinder Head  
Zylinderkopf  
Joint de culasse



Ltr	MODEL	PS/KW	ENGINE/MOTOR		
1,8 1761	4 CYL ø83 XANTIA XSARA ZX 07/92-->09/00	101 PS / 74 KW	LFZ (XU7JP)	61233002 0197.G4+0209.E1	<p>61207005 0209.E1 1,30mm 1 </p> <p>61207006 0209.L8 1,50mm 2 </p> <p>ø84,5</p>
1,8 1761	4 CYL ø83 XANTIA 16V XSARA PICASSO 16V XSARA 16V ZX ZX 16V 06/95-->	115 PS / 85 KW 110 PS / 81 KW	LFY (XU7JP4)		<p>62220005 0209.Q3 1,20mm 1 </p> <p>62220006 0209.V4 1,40mm 2 </p> <p>62220007 1,60mm 3 </p> <p>ø84</p>
1,8 1769	4 CYL ø 84 C 25 07/87->02/94	69 PS / 51 KW	169 (XM7T)	61210001 0197.L1 0197.15	<p>61210005 0209.F8 ø86,7</p>
1,9 1,905	4 CYL ø83 BX 19 BX 19 GTI ZX 06/88-->12/94 07/86-->12/94 12/87-->06/97	109 PS / 80 KW 102 PS / 75 KW 120 PS / 88 KW 95 PS / 70 KW 122 PS / 90 KW	DDZ (XU9M) DFZ (XU9J1) DKZ (XU9JA) D2C (XU92C) D2F D2A (XU92C) D2C (XU92C) D6A (XU9J2) 159A D6E (XU9JA)	61207002 0197.89+0209.E1  61207003 0197.H6+0209.E1	<p>61207005 0209.E1 1,30mm 1 </p> <p>61207006 0209.L8 1,50mm 2 </p> <p>ø84,5</p>

▲ : İçerikte Bulunmamaktadır...

▲ : Not included in the set

▲ : Non inclus dans la pochette

00: Motor Takım Keçesiz ve Subap Lastiksiz











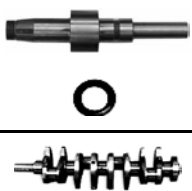
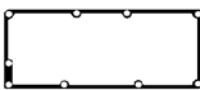











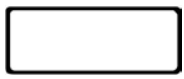



00: Gasket Set Without oil seals Without Valve Stem Seal

01: Motor Takım Keçesiz - Subap Lastikli

01: Gasket set With Valve Stem Seal Without Oil Seals

02: Motor Full Takım Keçeli ve Subap Lastikli

02: Gasket Full Set With oil seals and Valve Stem Seals

Subap Kapak Valve Cover Gasket Zylinderkopfhaube Couvre-culbut.	Karter Oil Pan Ölwanne Carter d'huile	Emme Manifold Intake Manifold Ansaug Admission	Egzoz Manifold Exhaust Manifold Auspuffkrümmer Collecteur D'echappement	Eksoz Boğaz Exhaust Pipe Auspuff Kehle	Supap Keçesi Valve Stem Seal Ventilschaft Queue de soupape	
						
 <b>61233025</b> 0249.71	 <b>61203013</b> 0304.34 93502226.	 <b>61233018x2</b> 0348.E6 + 0348F6	 <b>61233020x4</b> 1723.63		 <b>60107027x8</b> 0956.22 <b>8x10,8/14,2x10</b>	<b>21201019</b> 42x62x8 RD <b>21201040</b> 90x110x10 LD <b>21201062</b> 36x50x7 RD
 <b>61210525</b> 0249.14	 <b>61210013</b> 0304.44	 <b>61211016</b> 0348.33	 <b>61210020</b> 0349.03		 <b>60107027x8</b> 0956.22 <b>8x10,8/14,2x10</b>	
 <b>61207525</b> 0249.48 91508054	 <b>61203013</b> 0304.34 93502226  <b>61203014</b> 93501565	 <b>61203018x2</b> 91508659. BX->1984  <b>61207018</b> 951299280  <b>61207019</b> 0348.76	 <b>61207020x4</b> 0349.70 91505500  <b>61205019</b> 1721.01 7810024000	 <b>61207017</b> 1710.39 91511460	 <b>60107027x8</b> 0956.22 <b>8x10,8/14,2x10</b>	<b>21201019</b> 42x62x8 RD <b>21201040</b> 90x110x10 LD <b>21201062</b> 36x50x7 RD

■ : Delik - Çentik

■ : Hole - Notch

■ : Trou - Entaille

















NOT: Katalogdaki Orjinal Kodlar Referans Amacıyla Kullanılmıştır.Lütfen COTECH Kodlarını Kullanınız.  
Original codes used for reference only.Please use COTECH codes for orders.

00  
01  
02  
03  
04



Silindir Kapak  
Cylinder Head  
Zylinderkopf  
Joint de culasse



Ltr	MODEL	PS/KW	ENGINE/MOTOR		
1,9 1905	<b>4 CYL ø83</b> BERLINGO D 09/83-->12/94 BX 19 D C25 C25 Bus D C25 D JUMPER Bus D JUMPER D JUMPY D XANTIA D XSARA D ZX D DIESEL	70 PS / 51 KW 64 PS / 47 KW 68 PS / 50 KW	DJY (XUD9A) DJZ (XUD9Y) D9B (XUD9A/L) D9B (XUD9A/U) DHY (XUD9TE/Y) D9A (XUD9) 162 (XUD9) 162 (XUD9) DJZ (XUD9) D9B (XUD9) 169B(XUD0) XUD9A 169B(XUD0) 169B(XUD0)	<b>61204002</b> 0197.H5  <b>61204003</b> 0197.H4 	 <b>61204009</b> 0209.S5 1,36 mm 1  <b>61204008</b> 0209.S6 1,40 mm 2  <b>61204007</b> 0209.S7 1,44 mm 3  <b>61204006</b> 0209.S8 1,48 mm 4  <b>61204005</b> 0209.S9 1,53 mm 5  ø 84
1,9 1868	<b>4 CYL ø82,2</b> BERLINGO D JUMPY D XSARA D	70 PS / 51 KW	DW8B WJY (DW8B) WJZ (DW8)	<b>62173002</b> 0197.X6 	 <b>62173005</b> 0209.1C 1,47mm <b>62173006</b> 0209.X4 1,42mm 5  <b>62173007</b> 0209.X3 1,38mm 4  <b>62173008</b> 0209.X2 1,34mm 3  <b>62173009</b> 0209.X1 1,30mm 2  <b>62173010</b> 0209.X0 1,26mm 1  MLS ø84
2,0 1971	<b>4 CYL ø 88</b> C25 09/81-->03/94 C25 Bus	79 PS / 58 KW 84 PS / 62 KW	170A (XN1T) 170B (XN1T) 170C (XN1T)	<b>61211001</b> 9400197139	 <b>61211005</b> 0209.46 1,20mm <b>61211006</b> 1,80mm ø90











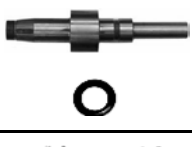
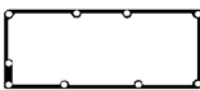





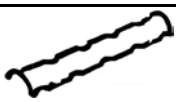



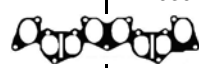



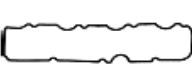

▲ : İçerikte Bulunmamaktadır...

▲ : Not included in the set

▲ : Non inclus dans la pochette

00: Motor Takım Keçesiz ve Subap Lastiksiz  
01: Motor Takım Keçesiz - Subap Lastikli  
02: Motor Full Takım Keçeli ve Subap Lastikli  
029

00: Gasket Set Without oil seals Without Valve Stem Seal  
01: Gasket set With Valve Stem Seal Without Oil Seals  
02: Gasket Full Set With oil seals and Valve Stem Seals

Subap Kapak Valve Cover Gasket Zylinderkopfhaube Couvre-culbut.	Karter Oil Pan Ölwanne Carter d'huile	Emme Manifold Intake Manifold Ansaug Admission	Egzoz Manifold Exhaust Manifold Auspuffkrümmer Collecteur D'echappement	Eksoz Boğaz Exhaust Pipe Auspuff Kehle	Supap Keçesi Valve Stem Seal Ventilschaft Queue de soupape	
						
 <b>61203525</b> 0249.46 0249.91	 <b>61203013</b> 0304.34  <b>61203014</b> 93501565	 <b>61203116x2</b> 0348.99  <b>61203018x2</b> 91508659  <b>61203021</b> 0348.JO	 <b>61205019</b> 1721.01 7810024000  <b>61203120x2</b> 0349.47 93010402		 <b>60107027x8</b> 0956.22 8x10,8/14,2x10	<b>21201011x2</b> 35x50x8 WD <b>21201019</b> 42x62x8 RD <b>21201040</b> 90x110x7 LD
 <b>62173025</b> 0249.95	 <b>61203013</b> 0304.34	 <b>62173018x2</b> 0348.N2	 <b>62173021x2</b> 0349.H7		 <b>60107027x8</b> 0956.22 8x10,8/14,2x10	<b>21208023</b> 35x50x8 RD <b>21201019</b> 42x62x8 RD <b>21201040</b> 90x110x10 LD
 <b>61210525</b> 0249.14	 <b>61210013</b> 0322.10 0304.11	 <b>61211016</b> 0348.33  <b>61211015</b> 0348.21	 <b>61210020</b> 0349.03  <b>61205017</b> 1710.09		 <b>60107027x8</b> 0956.22 8x10,8/14,2x10	

■ : Delik - Çentik

■ : Hole - Notch

■ : Trou - Entaille

NOT: Katalogdaki Orijinal Kodlar Referans Amacıyla Kullanılmıştır.Lütfen COTECH Kodlarını Kullanınız.  
Original codes used for reference only.Please use COTECH codes for orders.

00



01



02



03



04



Silindir Kapak  
Cylinder Head  
Zylinderkopf  
Joint de culasse



Ltr	MODEL	PS/KW	ENGINE/MOTOR		
2,0 1998	<b>4 CYL ø86</b> EVASION 16V 05/98-->04/00 XANTIA 16V 06/95-->04/03 XM 16V 05/94-->10/00 XSARA 16V 07/98-->09/00	132 PS / 97 KW	RFV (XU10J4R)		 <b>62170005</b> 0209.N6 1,35 mm 1  <b>62170006</b> 0209.T9 1,50mm 2  <b>ø87</b>
2,5 2500	<b>4 CYL ø93</b> CX 25 D 02/78-->02/94 CX 25 TRI CX 2500 D C25 Bus D C25 D	136 PS / 100KW 73 PS / 54 KW	CRD93L (U25-661) M25-629 M25-659 M25-660	<b>61215003</b> 0197K1	 <b>61215005</b> 0209.L5 1,40mm <b>ø95,5</b>
2,5 2500	<b>4 CYL ø93</b> CX 25 TD 04/83-->02/94 CX 2500 TD C25 Bus TD C25 DT	120 PS / 88 KW 95 PS / 75 KW	CRD93LS (U25-673) M25-648 M25-669	<b>61215103</b> 0197K1 TD	 <b>61215105</b> 0209.L6 1,40mm <b>ø95,5</b>
2,8 2798	<b>4 CYL ø94.4</b> JUMPER HDI 09/04-->04/02 JUMPER HDI 146 PS / 107 KW JUMPER 09/00-->06/06 87 PS / 64 KW	128 PS / 94 KW 146 PS / 107 KW 87 PS / 64 KW	F28TDCR 8140.43N 8140.43S	<b>60139100</b> 0197.Z4 0197.Y9 0197.Y2	 <b>60139005</b> 0209.OF 1,50mm  <b>60139006</b> 0209.OE 1,40mm  <b>60139007</b> 0209.OC 1,30mm <b>ø96</b>

▲ : İçerikte Bulunmamaktadır...

▲ : Not included in the set

▲ : Non inclus dans la pochette

00: Motor Takım Keçesiz ve Subap Lastiksiz











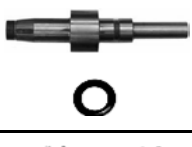
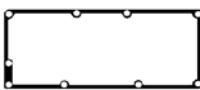







00: Gasket Set Without oil seals Without Valve Stem Seal

01: Motor Takım Keçesiz - Subap Lastikli

01: Gasket set With Valve Stem Seal Without Oil Seals

02: Motor Full Takım Keçeli ve Subap Lastikli

02: Gasket Full Set With oil seals and Valve Stem Seals

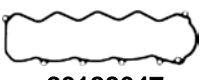
Subap Kapak Valve Cover Gasket Zylinderkopfhaube Couvre-culbut.	Karter Oil Pan Ölwanne Carter d'huile	Emme Manifold Intake Manifold Ansaug Admission	Egzoz Manifold Exhaust Manifold Auspuffkrümmer Collecteur D'echappement	Eksoz Boğaz Exhaust Pipe Auspuff Kehle	Supap Keçesi Valve Stem Seal Ventilschaft Queue de soupape	
						
						
<b>61215025</b> 5 450 155		<b>61215019x4</b> 0348.H0	<b>61215021x4</b> 0349.F0	<b>61215017</b> 95494600		
						
<b>61215025</b> 5 450 155		<b>61215019x4</b> 0348.H0	<b>61215021x4</b> 0349.F0	<b>61215017</b> 95494600		
						
<b>60138045</b> 0249.AO	<b>60138068</b> 500327440	<b>60146019x4</b> 98425767	<b>60147021x4</b> 98434020			
						
<b>60138047</b> 0249.C3						

■ : Delik - Çentik

■ : Hole - Notch

■ : Trou - Entaille

NOT: Katalogdaki Orijinal Kodlar Referans Amacıyla Kullanılmıştır.Lütfen COTECH Kodlarını Kullanınız.  
Original codes used for reference only.Please use COTECH codes for orders.

00



Silindir Kapak  
Cylinder Head

01



Zylinderkopf

02



Joint de culasse

03



04



Ltr	MODEL	PS/KW	ENGINE/MOTOR		
1,2 1149	4 CYL ø69 LOGAN 16V 2007-->	75 PS / 55 KW	D4DHIFLEX	60108703 77 01 475 822	 60108605 8200062273 MLS ø70
1,4 1390	4 CYL ø79,5 LOGAN SANDERO 09/04-->	75 PS / 55 KW 72 PS / 53 KW	K7J 710 K7J 714	60108902 Motor Full Takım Gasket Full Set 60108903 60 01 548 043  60149004 Motor Alt Takım Conversion Set	 60108905 82 00 296 969 1,20mm FIBER / FIBRE  60108906 82 00 296 969 MLS ø80,5
1,5 1461	4 CYL ø76 LOGAN DCI 09/05-->	65 PS / 48 KW	K9K 790	62456902 Motor Full Takım Gasket Full Set 62457003 77 01 476 729  62457104 Motor Alt Takım Conversion Set	 62457005 82 00 351 353 0,70mm  62457006 82 00 351 353 0,82mm MLS ø77,5
1,5 1461	4 CYL ø76 LOGAN DCI SANDERO DCI 01/06--> 09/07-->	68 PS / 50 KW 86 PS / 63 KW	K9K 792 K9K 796	62457002 Motor Full Takım Gasket Full Set  62457003 77 01 476 729  62457004 Motor Alt Takım Conversion Set	 62457005 82 00 351 353 0,70mm  62457006 82 00 351 353 0,82mm MLS ø77,5

▲ : İçerikte Bulunmamaktadır...

▲ : Not included in the set

▲ : Non inclus dans la pochette

00: Motor Takım Keçesiz ve Subap Lastiksiz











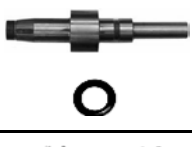
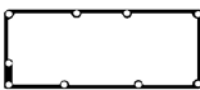





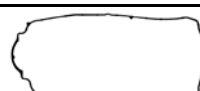



00: Gasket Set Without oil seals Without Valve Stem Seal

01: Motor Takım Keçesiz - Subap Lastikli

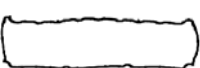
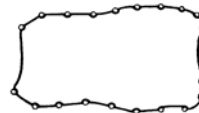
01: Gasket set With Valve Stem Seal Without Oil Seals

02: Motor Full Takım Keçeli ve Subap Lastikli

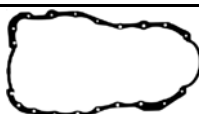
02: Gasket Full Set With oil seals and Valve Stem Seals

Subap Kapak Valve Cover Gasket Zylinderkopfhaube Couvre-culbut.	Karter Oil Pan Ölwanne Carter d'huile	Emme Manifold Intake Manifold Ansaug Admission	Egzoz Manifold Exhaust Manifold Auspuffkrümmer Collecteur D'echappement	Eksoz Boğaz Exhaust Pipe Auspuff Kehle	Supap Keçesi Valve Stem Seal Ventilschaft Queue de soupape	
						
 <b>60108725</b> 77 01 059 314		 <b>60108618</b> 77 01 473 007	 <b>60108621</b> 77 00 115 971		 <b>60108726x16</b> 82 00 171 215 5,5x8,3x11,5x8	<b>21204701</b> 28x47x8 RD
 <b>60116527</b> 77 01 471 719	 <b>62457165</b> 77 00 273 486	 <b>60108918x4</b> 77 01 471 932	 <b>60108921</b> 8200191371		 <b>60116026x8</b> 77 00 103 872 7x9,8/13.2x10	<b>21208003</b> 30x42x7 RD <b>21208001</b> 35x47x7 RD <b>21208012</b> 80x100x8 LD
 <b>62457125</b> 82 00 317 650	 <b>62457165</b> 77 00 273 486		 <b>62457021</b> 82 00 414 346		 <b>62457144x8</b> 77 00 109 840 6x8,8x12,2x9,7	<b>21204024</b> 28x42x5 RD <b>21204025</b> 35x47x7 RD <b>21204033</b> 80x100x9 LD
 <b>62457125</b> 82 00 317 650	 <b>62457065</b> 82 00 379 654		 <b>62457021</b> 82 00 414 346		 <b>62457144x8</b> 77 00 109 840 6x8,8x12,2x9,7	<b>21204024</b> 28x42x5 RD <b>21204025</b> 35x47x7 RD <b>21204033</b> 80x100x9 LD

■ : Delik - Çentik

■ : Hole - Notch

■ : Trou - Entaille

NOT: Katalogdaki Orijinal Kodlar Referans Amacıyla Kullanılmıştır.Lütfen COTECH Kodlarını Kullanınız.  
Original codes used for reference only.Please use COTECH codes for orders.

**DACIA**

00



Silindir Kapak

Cylinder Head

01



Zylinderkopf

02



Joint de culasse

03



04



Ltr	MODEL	PS/KW	ENGINE/MOTOR		
1,6 1598	<b>4 CYL ø79,5</b> LOGAN 09/04--> SANDERO 06/08-->	105 PS / 77 KW 84 PS / 62 KW 87 PS / 62 KW	K7M 690 K7M 710 K7M 718 K7M 732	<b>60108902</b> Motor Full Takım Gasket Full Set  <b>60108903</b> 60 01 548 043  <b>60149004</b> Motor Alt Takım Conversion Set	 <b>60108905</b> 82 00 296 969 1,20mm FIBER / FIBRE  <b>60108906</b> 82 00 296 969 MLS ø80,5
1,6 1598	<b>4 CYL ø79,5</b> LOGAN 16V 02/06-->	105 PS / 77 KW	K4M 690 K4M 694	<b>62456602</b> Motor Full Takım Gasket Full Set  <b>62456603</b> 77 01 471 886  <b>62457204</b> Alt Takım Conversion Set	 <b>62457205</b> 77 00 112 739 MLS ø80,5

▲ : İçerikte Bulunmamaktadır...

▲ : Not included in the set

▲ : Non inclus dans la pochette

00: Motor Takım Keçesiz ve Subap Lastiksiz











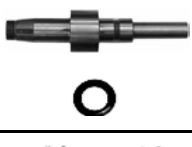
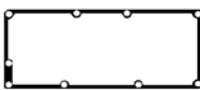



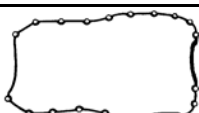

00: Gasket Set Without oil seals Without Valve Stem Seal

01: Motor Takım Keçesiz - Subap Lastikli

01: Gasket set With Valve Stem Seal Without Oil Seals

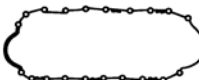
02: Motor Full Takım Keçeli ve Subap Lastikli

02: Gasket Full Set With oil seals and Valve Stem Seals

Subap Kapak Valve Cover Gasket Zylinderkopfhaube Couvre-culbut.	Karter Oil Pan Ölwanne Carter d'huile	Emme Manifold Intake Manifold Ansaug Admission	Egzoz Manifold Exhaust Manifold Auspuffkrümmer Collecteur D'echappement	Eksoz Boğaz Exhaust Pipe Auspuff Kehle	Supap Keçesi Valve Stem Seal Ventilschaft Queue de soupape	
						
						<b>21208003</b> 30x42x7 RD
<b>60116527</b> 77 01 471 719	<b>62457165</b> 77 00 273 486	<b>60108918x4</b> 77 01 471 932	<b>60108921</b> 8200191371		<b>60116026x8</b> 77 00 103 872 <b>7x9,8/13.2x10</b>	<b>21208001</b> 35x47x7 RD
						<b>21208012</b> 80x100x8 LD
						<b>21204024x2</b> 28x42x5 RD
	<b>62457265</b> 77 00 103 687	<b>62457418x4</b> 82 00 275 057	<b>62457222</b> 82 00 365 915		<b>62457244x16</b> 77 00 103 938 <b>5,5x11x28x16,4</b>	<b>21204005</b> 35x47x7 RD
						<b>21204009</b> 80x100x8 LD
		<b>62457219</b> 77 00 105 852				

■ : Delik - Çentik

■ : Hole - Notch

■ : Trou - Entaille

NOT: Katalogdaki Orijinal Kodlar Referans Amacıyla Kullanılmıştır.Lütfen COTECH Kodlarını Kullanınız.  
Original codes used for reference only.Please use COTECH codes for orders.

00



Silindir Kapak  
Cylinder Head  
Zylinderkopf  
Joint de culasse

01



02



03



04

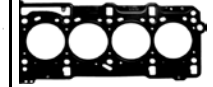

Ltr	MODEL	PS/KW	ENGINE/MOTOR		
0,8	3 CYL ø68,5 MATIZ TICO SPARK (SOHC ) 01/96-->12/00	52 PS / 38 KW 48 PS / 35 KW	F8CV F8CV		 <b>61460105</b> 11141A78B01-00 1,30mm ø69,5
1,4 1349	4 CYL ø77,6 LANOS 05/97-->	75 PS / 55 KW	A13DM A14SMS A13SMS	<b>62447103</b> 1606730	 <b>62447205</b> 607449 1,80mm ø79,5
1,4 1393	4 CYL ø77,9 KALOS AVEO (SOHC ) 1102-->12/04	83 PS / 61KW	F14S3		 <b>62447305</b> 5607408-607988 1,40mm ø80,5
1,4 1399	4 CYL ø77,9 KALOS OPTRA LACETTI ( DOCH16V ) 10/03-->12/05	94 PS / 69 KW	F14D3 F14D5		 <b>62450205</b> 96378802 1,20mm FIBER / FIBRE ø80
1,4 1399	4 CYL ø77,9 AVEO LACETTI NUBIRA OPTRA KALOS (DOCH 16 V ) 03/05-->12/07	94 PS / 69 KW	F14D3		 <b>62450105</b> 96473400 1,20mm FIBER / FIBRE ø80
1,5 1498	4 CYL ø76,5 ESPERO CIELO NEXIA ( DOCH 16V ) 02/95-->06/99	90 PS / 6 KW	A15MF		 <b>61504005</b> 96391435 1,40mm  <b>61504006</b> 96391435 2,00mm ø78

▲ : İçerikte Bulunmamaktadır...

▲ : Not included in the set

▲ : Non inclus dans la pochette

00: Motor Takım Keçesiz ve Subap Lastiksiz









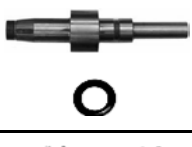
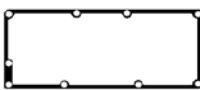

00: Gasket Set Without oil seals Without Valve Stem Seal

01: Motor Takım Keçesiz - Subap Lastikli

01: Gasket set With Valve Stem Seal Without Oil Seals

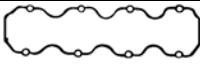
02: Motor Full Takım Keçeli ve Subap Lastikli

02: Gasket Full Set With oil seals and Valve Stem Seals

Subap Kapak Valve Cover Gasket Zylinderkopfhaube Couvre-culbut.	Karter Oil Pan Ölwanne Carter d'huile	Emme Manifold Intake Manifold Ansaug Admission	Egzoz Manifold Exhaust Manifold Auspuffkrümmer Collecteur D'echappement	Eksoz Boğaz Exhaust Pipe Auspuff Kehle	Supap Keçesi Valve Stem Seal Ventilschaft Queue de soupape	
						
						
<b>62447236</b> 638 260 Kauçuk Rubber		<b>62447319</b> 850 607	<b>62447221</b> 850 615		<b>62447227x8</b> 642527 7x11,1/16x10	<b>21201014</b> 35x48x7 RD

■ : Delik - Çentik

■ : Hole - Notch

■ : Trou - Entaille

NOT: Katalogdaki Orijinal Kodlar Referans Amacıyla Kullanılmıştır.Lütfen COTECH Kodlarını Kullanınız.  
Original codes used for reference only.Please use COTECH codes for orders.

00



01



02



03



04



Silindir Kapak  
Cylinder Head  
Zylinderkopf  
Joint de culasse



Ltr	MODEL	PS/KW	ENGINE/MOTOR		
1,5 1498	4 CYL ø77,6 LACETTI 04/97--> LANOS NUBIRA	110 PS / 81 KW 86 PS / 63 KW	A15DMS A15SMS	62447103 1606730	 62447205 607449 1,80mm ø79,5
1,5 1498	4 CYL ø79 NEXIA 07/94-->08/97 ESPERO CIELO LEMANS	78 PS / 57 KW 60 PS / 44 KW	G15MF 16SV	62447302 Motor Full Takım Gasket Full Set 62447303 1606673+1606689 62447204 1606728+1606686	 62447305 5607408-607988 1,40mm ø80,5
1,6 1598	4 CYL ø79 AVEO 07/03-->03/05 KALOS NUBIRA OPTRA LACETTI ( DOCH 16V )	109 PS / 80 KW	F16D3		 62450205 96378802 1,20mm FIBER / FIBRE ø80
1,8 1796	4 CYL ø84,8 ESPERO 02/95-->07/03 LACETTI 08/92-->08/95 LEGANZA SUPER SALOON PRINCE ARANOS (SOHC )	95 PS / 70 KW 90 PS / 60 KW 101 PS / 70 KW	C18LE S 18 NV	62447502 Motor Full Takım Gasket Full Set 62447503 1606666 62447504 1606663	 62447505 607986 1,40mm ø86,3
1,8 1799	4 CYL ø81,6 LACETTI 16 V 07/03--> NUBIRA 16 V	122 PS / 90 KW	T18SED	62448603 1606914	 62448605 608809 1,40mm ø83

▲ : İçerikte Bulunmamaktadır...

▲ : Not included in the set

▲ : Non inclus dans la pochette

00: Motor Takım Keçesiz ve Subap Lastiksiz











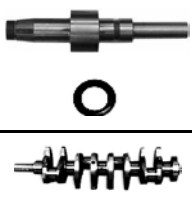
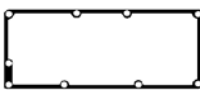





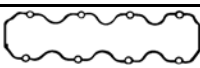



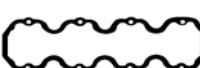



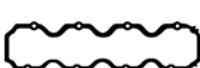
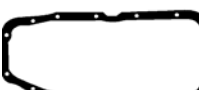
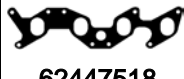

00: Gasket Set Without oil seals Without Valve Stem Seal

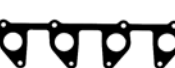
01: Motor Takım Keçesiz - Subap Lastikli

01: Gasket set With Valve Stem Seal Without Oil Seals

02: Motor Full Takım Keçeli ve Subap Lastikli

02: Gasket Full Set With oil seals and Valve Stem Seals

Subap Kapak Valve Cover Gasket Zylinderkopfhaube Couvre-culbut.	Karter Oil Pan Ölwanne Carter d'huile	Emme Manifold Intake Manifold Ansaug Admission	Egzoz Manifold Exhaust Manifold Auspuffkrümmer Collecteur D'echappement	Eksoz Boğaz Exhaust Pipe Auspuff Kehle	Supap Keçesi Valve Stem Seal Ventilschaft Queue de soupape	
						
 <b>62447236</b> 638 260 Kauçuk Rubber		 <b>62447319</b> 850 607	 <b>62447221</b> 850 615		 <b>62447227x8</b> 642527 7x11,1/16x10	<b>21201014</b> 35x48x7 RD
 <b>62447235</b> 638727	 <b>62447265</b> 652577	 <b>62447219</b> 850634	 <b>62447221</b> 850 615	 <b>62447517</b> 854933	 <b>62447227x8</b> 642527 7x11,1/16x10	<b>21201014</b> 35x48x7 RD <b>21208007</b> 26x42x8 RD <b>21208013</b> 80x98x10 LD
 <b>62447534</b> 638192	 <b>62447564</b> 652587	 <b>62447518</b> 850600  <b>62447719</b> 850601	 <b>62447521</b> 850645	 <b>62447517</b> 854933	 <b>62447227x8</b> 642527 7x11,1/16x10	<b>21201014</b> 35x48x7 RD <b>21208020</b> 31x50x8 RD <b>21208019</b> 90x104x11 LD
 <b>62447625</b> 607647		 <b>62447619</b> 850655	 <b>62447621</b> 850656	 <b>62447517</b> 854933	 <b>62447426x16</b> 6x8,8x12,2x9,7	<b>21201014</b> 35x48x7 RD 2x

■ : Delik - Çentik

■ : Hole - Notch

■ : Trou - Entaille

NOT: Katalogdaki Orjinal Kodlar Referans Amacıyla Kullanılmıştır.Lütfen COTECH Kodlarını Kullanınız.  
Original codes used for reference only.Please use COTECH codes for orders.

00



Silindir Kapak

Cylinder Head

01



Zylinderkopf

02



Joint de culasse

03



04



Ltr	MODEL	PS/KW	ENGINE/MOTOR		
2,0 1998	<b>4 CYL ø86</b> ESPERO 10/93-->06/99 LEGANZA LEMANS RACER PRINCE MAGNUS COMPACT ARANOS NUBIRA II (SOHC)	110 PS / 81 KW 105 PS / 77 KW	C20LE C20NE	<b>62447700</b>  <b>62447702</b> Motor Full Takım Gasket Full Set <b>62447703</b> 1606664  <b>62447504</b> 1606663	  <b>62447705</b> 607987 1,30mm  <b>ø87,5</b>
2,0 1998	<b>4 CYL ø86</b> LEGANZA 16 V 05/97--> NUBIRA II 16 V 07/00--> LACETTI 16 V MAGNUS 16 V REZZO 16 V (DOHC)	126 PS / 93 KW 133 PS / 98 KW 121 PS / 89 KW	T20SED X 20 SED Z20L X22SED	<b>62447603</b> 1606770	  <b>62447605</b> 5607449 1,30mm  <b>ø87,5</b>

▲ : İçerikte Bulunmamaktadır...

▲ : Not included in the set

▲ : Non inclus dans la pochette

00: Motor Takım Keçesiz ve Subap Lastiksiz













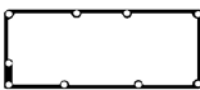



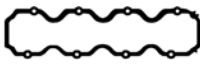

00: Gasket Set Without oil seals Without Valve Stem Seal

01: Motor Takım Keçesiz - Subap Lastikli

01: Gasket set With Valve Stem Seal Without Oil Seals

02: Motor Full Takım Keçeli ve Subap Lastikli

02: Gasket Full Set With oil seals and Valve Stem Seals

Subap Kapak Valve Cover Gasket Zylinderkopfhaube Couvre-culbut.	Karter Oil Pan Ölwanne Carter d'huile	Emme Manifold Intake Manifold Ansaug Admission	Egzoz Manifold Exhaust Manifold Auspuffkrümmer Collecteur D'echappement	Eksoz Boğaz Exhaust Pipe Auspuff Kehle	Supap Keçesi Valve Stem Seal Ventilschaft Queue de soupape	 
						
 <b>62447534</b> 638192	 <b>62447564</b> 652587	 <b>62447719</b> 850601	 <b>62447521</b> 850645	 <b>42447517</b> 854933	 <b>62447227x8</b> 642527 <b>7x11,1/16x10</b>	<b>21201014</b> 35x48x7 RD
 <b>62447625</b> 607647		 <b>62447619</b> 850655	 <b>62447621</b> 850656		 <b>62447426x16</b> 642533 <b>6x8.8x12.2x9.7</b>	<b>21208020</b> 31x50x8 RD
						<b>21208019</b> 90x104x11 LD

■ : Delik - Çentik

■ : Hole - Notch

■ : Trou - Entaille

NOT: Katalogdaki Orijinal Kodlar Referans Amacıyla Kullanılmıştır.Lütfen COTECH Kodlarını Kullanınız.  
Original codes used for reference only.Please use COTECH codes for orders.

00



Silindir Kapak

Cylinder Head

01



Zylinderkopf

02



Joint de culasse

03



04



Ltr	MODEL	PS/KW	ENGINE/MOTOR	
1,0 993	<b>3 CYL ø76</b> CHARADE 03/87-->12/92	52 PS / 38 KW	CB12 CB23 CB37 CBT50	 <b>61460005</b> 11115-87714 1,80mm ø77,5
1,6 1587	<b>4 CYL ø80,5</b> DELTA TAFT 09/72-->02/85	67 PS / 49 KW	12R	 <b>61411505</b> 11115-31020 1,80mm <b>61411506</b> 11115-31020 2,0mm ø83
1,8 1812	<b>4 CYL ø86</b> DELTA WIDE 02/85-->	88 PS / 65 KW	2Y	 <b>61411605</b> 11115-71010 1,80mm <b>61411606</b> 11115-71010 2,0mm ø88
2,0 1998	<b>4 CYL ø86</b> DELTA WIDE ROCKY RUGGER TAFT 02/85-->04/93	88 PS / 65 KW	3Y	 <b>61411605</b> 11115-71010 1,80mm <b>61411606</b> 11115-71010 2,0mm ø88
2,2 2237	<b>4 CYL ø91</b> ROCKY 05/93-->06/01	88 PS / 65 KW	4Y	 <b>61411105</b> 11115-73010 1,60mm <b>61411106</b> 11115-73010 2,00mm ø93

▲ : İçerikte Bulunmamaktadır...

▲ : Not included in the set

▲ : Non inclus dans la pochette

00: Motor Takım Keçesiz ve Subap Lastiksiz







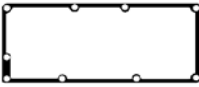

00: Gasket Set Without oil seals Without Valve Stem Seal

01: Motor Takım Keçesiz - Subap Lastikli

01: Gasket set With Valve Stem Seal Without Oil Seals

02: Motor Full Takım Keçeli ve Subap Lastikli

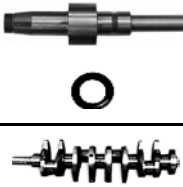
02: Gasket Full Set With oil seals and Valve Stem Seals

<p>Subap Kapak Valve Cover Gasket Zylinderkopfhaube Couvre-culbut.</p> 	<p>Karter Oil Pan Ölwanne Carter d'huile</p> 	<p>Emme Manifold Intake Manifold Ansaug Admission</p> 	<p>Egzoz Manifold Exhaust Manifold Auspuffkrümmer Collecteur D'echappement</p> 	<p>Eksoz Boğaz Exhaust Pipe Auspuff Kehle</p> 	<p>Supap Keçesi Valve Stem Seal Ventilschaft Queue de soupape</p> 	
		 <p>61415720 17172-71010</p>				
		 <p>61415720 17172-71010</p>				

■ : Delik - Çentik

■ : Hole - Notch

■ : Trou - Entaille

NOT: Katalogdaki Orijinal Kodlar Referans Amacıyla Kullanılmıştır.Lütfen COTECH Kodlarını Kullanınız.  
Original codes used for reference only.Please use COTECH codes for orders.

00



Silindir Kapak  
Cylinder Head

01



Zylinderkopf

02



Joint de culasse

03



04

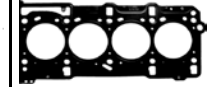

Ltr	MODEL	PS/KW	ENGINE/MOTOR		
0,8 767	<b>4 CYL ø62</b> 600 D 10/60-->02/70 600 E 600 T 770 S 10/60-->08/68  2 Serie Furgoneta	23 PS / 17 KW  25 PS / 18 KW	100 D.000  100 D.000	<b>63113002</b> 588041+4387608  <b>63113000</b> 588041	 <b>63113005</b> 4387608 1,20mm  <b>63113006</b> 4064640 1,80mm ø64
0,8 843	<b>4 CYL ø65</b> 850 07/64-->10/72 850 VAN 03/68-->10/72  Furgoneta Special T Familiare Van	35 PS / 25 KW 48 PS / 35 KW	100 G.000 100 G.000	<b>60313002</b> 5880412 5881112  <b>60313000</b> 5880412 5881112	 <b>60313005</b> 7745836 1,20mm  <b>60313006</b> 7539220 1,80mm ø66
0,9 903	<b>4 CYL ø65</b> 850 02/68-->12/72 900 E 01/78-->01/86 900 T 01/78-->01/86  Panorama Pulmino Spider Sport Coupe T Familiare	32 PS / 24 KW 52 PS / 38 KW 35 PS / 26 KW	100 G.000 100 G.000 100 G.000	<b>60313002</b> 5880412 5881112  <b>60313000</b> 5880412 5881112	 <b>60313005</b> 7745836 1,20mm  <b>60313006</b> 7539220 1,80mm ø66
0,9 903	<b>4 CYL ø65</b> 127 ESPECIAL 1974--> PANDA 34 10/1980-->06/1994 PANDA 35 10/1980-->06/1994 PANDA 4x2 10/1980-->06/1994 UNO 45 1988--> PANDA 10/80-->06/94	34 PS / 25 KW 45 PS / 33 KW	146 A.000 146 A.048 100 CL3.000		 <b>60313005</b> 7745836 1,20mm  <b>60313006</b> 7539220 1,80mm ø66

▲ : İçerikte Bulunmamaktadır...

▲ : Not included in the set

▲ : Non inclus dans la pochette

00: Motor Takım Keçesiz ve Subap Lastiksiz











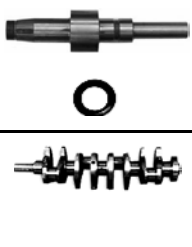
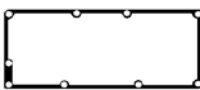



00: Gasket Set Without oil seals Without Valve Stem Seal

01: Motor Takım Keçesiz - Subap Lastikli

01: Gasket set With Valve Stem Seal Without Oil Seals

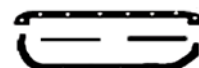
02: Motor Full Takım Keçeli ve Subap Lastikli

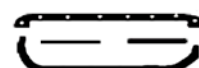
02: Gasket Full Set With oil seals and Valve Stem Seals

Subap Kapak Valve Cover Gasket Zylinderkopfhaube Couvre-culbut.	Karter Oil Pan Ölwanne Carter d'huile	Emme Manifold Intake Manifold Ansaug Admission	Egzoz Manifold Exhaust Manifold Auspuffkrümmer Collecteur D'echappement	Eksoz Boğaz Exhaust Pipe Auspuff Kehle	Supap Keçesi Valve Stem Seal Ventilschaft Queue de soupape	
						
 <b>60313034</b> 4145587	 <b>60313013</b> 5882343	 <b>60313020</b> 4127971				<b>21201064</b> 42x56x7 LD <b>21201065</b> 64x80x8 RD
 <b>60313034</b> 4145587	 <b>60313013</b> 5882343	 <b>60313020</b> 4127971				<b>21201064</b> 42x56x7 LD <b>21201065</b> 64x80x8 RD
 <b>60313034</b> 4145587	 <b>60313013</b> 5882343	 <b>60313020</b> 4127971				<b>21201064</b> 42x56x7 LD <b>21201065</b> 64x80x8 RD

■ : Delik - Çentik

■ : Hole - Notch

■ : Trou - Entaille

NOT: Katalogdaki Orijinal Kodlar Referans Amacıyla Kullanılmıştır.Lütfen COTECH Kodlarını Kullanınız.  
Original codes used for reference only.Please use COTECH codes for orders.

00



Silindir Kapak  
Cylinder Head

01



Zylinderkopf

02



Joint de culasse

03



04



Ltr	MODEL	PS/KW	ENGINE/MOTOR		
1,0 999	<b>4 CYL ø70</b> PANDA 01/86-->12/92 PANDA 1000 05/86-->03/95 PANDA 45 05/86-->03/95 UNO 45 05/86-->03/95  45 Fire SPI	45 PS / 33 KW 50 PS / 37 KW 45 PS / 33 KW	156 A2.000 156 A2.100 156 A2.146 141 C2.000 156 A3.000 156 A3.100 156 A2.246 156.A2.048 146.A2.166 146.D8.000	<b>60340102</b> 5892376  <b>60340100</b> 5892376  <b>60340103</b> 5882345	 <b>60340005</b> 7640784 1,80mm <b>ø71,5</b>
1,0 1049	<b>4 CYL ø76</b> 127 09/71-->02/82 127 09/79-->02/82 FIORINO RITMO STRADA 60 No:475521-->	70 PS / 51 KW 60 PS / 44 KW	127 A1.000 127 A6.000 127 A.000	<b>63114002</b> 5891802 5891843  <b>63114000</b> 5891802 5891843	 <b>63114005</b> 5960967 1,20mm  <b>63114006</b> 5960968 1,80mm <b>ø77</b>
1,0 1049	<b>4 CYL ø76</b> 127 09/71-->02/82 127 09/79-->02/82 FIORINO RITMO STRADA 60 No:475520 <--	70 PS / 51 KW 60 PS / 44 KW	127 A1.000 127 A6.000 127 A.000	<b>63114102</b> 5882059  <b>63114100</b> 5882059	 <b>63114005</b> 5960967 1,20mm  <b>63114006</b> 5960968 1,80mm <b>ø77</b>
1,1 1108	<b>4 CYL ø70</b> TIPO 01/89-->09/99 UNO 01/89-->09/99 PANDA 10/94-->01/98 PUNTO 55 01/93-->09/99 CINQUENTO 10/94-->01/98 SEICENTO 01/95-->	54 PS / 40 KW 49 PS / 36 KW	160 A3.000 176 A6.000 176 B2.000 156 C.046 146 C3.000 156 B2.000 178 B9.033	<b>60340002</b> 5893658  <b>60340001</b> 5893658  <b>60340003</b> 5888218	 <b>60340005</b> 7640784 1,80mm <b>ø71,5</b>

▲ : İçerikte Bulunmamaktadır...

▲ : Not included in the set

▲ : Non inclus dans la pochette

00: Motor Takım Keçesiz ve Subap Lastiksiz











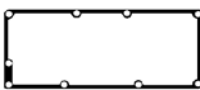





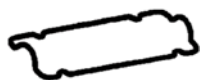



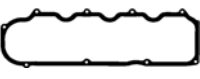

00: Gasket Set Without oil seals Without Valve Stem Seal

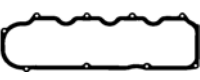
01: Motor Takım Keçesiz - Subap Lastikli

01: Gasket set With Valve Stem Seal Without Oil Seals

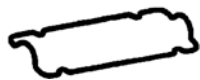
02: Motor Full Takım Keçeli ve Subap Lastikli

02: Gasket Full Set With oil seals and Valve Stem Seals

Subap Kapak Valve Cover Gasket Zylinderkopfhaube Couvre-culbut.	Karter Oil Pan Ölwanne Carter d'huile	Emme Manifold Intake Manifold Ansaug Admission	Egzoz Manifold Exhaust Manifold Auspuffkrümmer Collecteur D'echappement	Eksoz Boğaz Exhaust Pipe Auspuff Kehle	Supap Keçesi Valve Stem Seal Ventilschaft Queue de soupape	
						
 <b>60340025</b> 7688450		 <b>60340119</b> 7597583	 <b>60340120x4</b> 7579740		 <b>60116026x8</b> 5930415 <b>7x9,8/13.2x10</b>	<b>21208003</b> 30x42x7 RD <b>21201072</b> 23x35x7 RD <b>21201053</b> 70x88x8 LD
 <b>63114034</b> 4323710	 <b>63114013</b> 4249510	 <b>63114020x2</b> 4398359			 <b>60107027x8</b> 7553637 <b>8x10,8x14,2x10</b>	<b>21201006</b> 30x52x7 RD <b>21201017</b> 40x56x7 RD <b>21201063</b> 70x85x8 LD
 <b>63114034</b> 4323710	 <b>63114013</b> 4249510	 <b>63114020x2</b> 4398359			 <b>60107027x8</b> 7553637 <b>8x10,8x14,2x10</b>	<b>21201006</b> 30x52x7 RD <b>21201017</b> 40x56x7 RD <b>21201030</b> 64x80x8 LD
 <b>60340025</b> 7688450		 <b>60340019</b> 46426046 46754320	 <b>60340020x2</b> 7749711		 <b>60116026x8</b> 5930415 <b>7x9,8/13.2x10</b>	<b>21208003</b> 30x42x7 RD <b>21201072</b> 23x35x7 RD <b>21201053</b> 70x88x8 LD

■ : Delik - Çentik

■ : Hole - Notch

■ : Trou - Entaille

NOT: Katalogdaki Orjinal Kodlar Referans Amacıyla Kullanılmıştır.Lütfen COTECH Kodlarını Kullanınız.  
Original codes used for reference only.Please use COTECH codes for orders.

FIAT

00



01



02



03



04



Silindir Kapak  
Cylinder Head  
Zylinderkopf  
Joint de culasse



Ltr	MODEL	PS/KW	ENGINE/MOTOR		
1,1 1108	<b>4 CYL ø70</b> PANDA 02/95-->09/03 PANDA 4x2 09/03--> PANDA 4x4 09/03--> SEICENTO 01/98-->01/10	54 PS / 40 KW	187 A1.000	60340402 71716869 60340401 71716869 60340403 71718390	 60340005 7640784 1,80mm ø71,5
1,1 1108	<b>4 CYL ø70</b> PANDA 02/95-->07/04 PALIO TIPO 01/88-->10/91 UNO 60 04/89-->12/92 Fire SPI	50 PS / 37 KW 54 PS / 40 KW 56 PS / 41 KW 57 PS / 42 KW	145 C.046 176 B2.000 178 B9.033 160 A.3000	60340102 5892376 60340100 5892376 60340103 5882345	 60340005 7640784 1,80mm ø71,5
1,1 1116	<b>4 CYL ø80</b> 128 03/69-->12/84 RITMO 60 1978-->1982 STRADA 1979-->1982 60 L-CL Pick-Up Todos Tipos Motor All Engine Types Tous Types de Moteur	55 PS / 40 KW 60 PS / 44 KW 45 PS / 33 KW	128 A 138 A.000 128 AC5.000 128 A.048	60306002 5881135 60306000 5881135	 60306005 4387618 1,20mm ø81
1,1 1116	<b>4 CYL ø80</b> 128 03/69-->12/84 RITMO 60 1978-->1982 STRADA 1979-->1982 60 L-CL Pick-Up Todos Tipos Motor All Engine Types Tous Types de Moteur	55 PS / 40 KW 60 PS / 44 KW 45 PS / 33 KW	128 A 138 A.000 128 AC5.000 128 A.048	60306102 60306100	 60306006 4406740 1,80mm ø81
1,2 1197	<b>4 CYL ø73</b> 124 02/73-->07/75 Berlina	65 PS / 48 KW	124 A.000	60301002 5880424	 60301005 4387614 1,20mm ø78











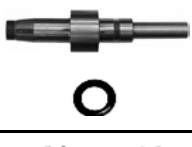
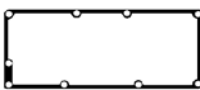





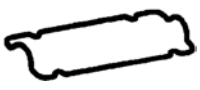
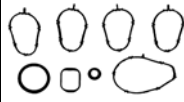





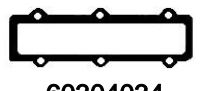

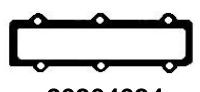

▲ : İçerikte Bulunmamaktadır...

▲ : Not included in the set

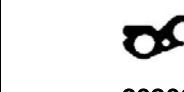
▲ : Non inclus dans la pochette

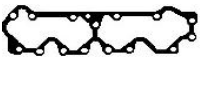
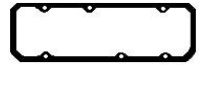
00: Motor Takım Keçesiz ve Subap Lastiksiz  
01: Motor Takım Keçesiz - Subap Lastikli  
02: Motor Full Takım Keçeli ve Subap Lastikli  
049

00: Gasket Set Without oil seals Without Valve Stem Seal  
01: Gasket set With Valve Stem Seal Without Oil Seals  
02: Gasket Full Set With oil seals and Valve Stem Seals

Subap Kapak Valve Cover Gasket Zylinderkopfhaube Couvre-culbut.	Karter Oil Pan Ölwanne Carter d'huile	Emme Manifold Intake Manifold Ansaug Admission	Egzoz Manifold Exhaust Manifold Auspuffkrümmer Collecteur D'échappement	Eksoz Boğaz Exhaust Pipe Auspuff Kehle	Supap Keçesi Valve Stem Seal Ventilschaft Queue de soupape	
						
 <b>60340025</b> 7688450		 <b>60340418</b> 71716684	 <b>60340020x2</b> 7749711		 <b>60116026x8</b> 5930415 7x9,8/13.2x10	<b>21208003</b> 30x42x7 RD
 <b>60340025</b> 7688450		 <b>60340119</b> 7597583	 <b>60340120x4</b> 7579740		 <b>60116026x8</b> 5930415 7x9,8/13.2x10	<b>21208041</b> 74x88x8 LD
 <b>60304034</b> 4448677	 <b>60306013</b> 4179038	 <b>60306020x2</b> 4309031		 <b>60301018</b> 4147260	 <b>60107027x8</b> 7553637 8x10,8x14,2x10	<b>21201072</b> 23x35x7 RD
 <b>60304035</b> 7784728						<b>21208003</b> 30x42x7 RD
 <b>60304034</b> 4448677	 <b>60306013</b> 4179038	 <b>60306020x2</b> 4309031		 <b>60301018</b> 4147260	 <b>60107027x8</b> 7553637 8x10,8x14,2x10	<b>21201072</b> 23x35x7 RD
 <b>60304035</b> 7784728						<b>21201053</b> 70x88x8 LD
 <b>60301034</b> 4130541	 <b>60301013</b> 4129756	 <b>60301020x2</b> 4177631		 <b>60301018</b> 4147260	 <b>60107027x8</b> 7553637 8x10,8x14,2x10	<b>21201006</b> 30x52x7 RD
						<b>21201017</b> 40x56x7 RD
						<b>21201030</b> 64x80x8 LD
						<b>21201066</b> 70x90x10 RD

■ : Delik - Çentik

■ : Hole - Notch

■ : Trou - Entaille

NOT: Katalogdaki Orjinal Kodlar Referans Amacıyla Kullanılmıştır.Lütfen COTECH Kodlarını Kullanınız.  
Original codes used for reference only.Please use COTECH codes for orders.

FIAT

00



Silindir Kapak  
Cylinder Head

01



Zylinderkopf

02



Joint de culasse

03



04



Ltr	MODEL	PS/KW	ENGINE/MOTOR		
1,2 1242	<b>4 CYL ø70,8</b> PUNTO 60 01/94-->09/99 PUNTO SELECT/ 01/94-->09/99 PUNTO 75 11/93--> PALIO 75 01/94-->09/99 SIENA 04/96--> PUNTO 60 CABRIO	58 PS / 43 KW 73 PS / 54 KW 75 PS / 55 KW 60 PS / 44 KW	176 A7.000 176 A8.000 176 B1.000 176 A7.000 176 B4.000	<b>60340202</b> 5893660  <b>60340201</b> 5893660  <b>60340203</b> 5893663 5893661	 <b>60340005</b> 7640784 1,80mm <b>ø71,5</b>
1,2 1242	<b>4 CYL ø70,8</b> PUNTO 16V 1997-->1999 MAREA 16V 1999--> PUNTO CABRIO 16 V BRAVA 12/98-->10/00 BRAVO 12/98-->10/00 STILO 02/02--> Active Dynamic	86 PS / 63 KW 82 PS / 60 KW	182 B2.000 176 B9.000 182 A2.000		 <b>62427907</b> 46434596 1,80mm <b>ø72</b>
1,2 1242	<b>4 CYL ø70,8</b> BRAVA 16V 10/00-->10/01 BRAVO 16V 10/00-->10/01 IDEA 16V 09/99--> PUNTO 16V 10/97-->09/99 STILO 16V 09/99-->	80 PS / 59 KW 82 PS / 60 KW	188 A5.000 176 B9.000	<b>60340302</b> 71716871	 <b>62427907</b> 46434596 1,80mm <b>ø72</b>
1,2 1242	<b>4 CYL ø70,8</b> PUNTO 09/99--> DOBLO 03/01--> PANDA 09/03--> STRADA 10/99-->03/03	60 PS / 44 KW 65 PS / 48 KW	188 A4.000 223 A5.000	<b>60340402</b> 71716869 71728827  <b>60340401</b> 71716869 71728827  <b>60340403</b> 71718390	 <b>60340005</b> 7640784 1,80mm <b>ø71,5</b>

▲ : İçerikte Bulunmamaktadır...

▲ : Not included in the set

▲ : Non inclus dans la pochette

00: Motor Takım Keçesiz ve Subap Lastiksiz











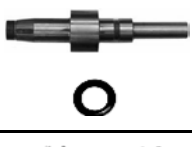
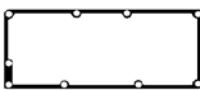







00: Gasket Set Without oil seals Without Valve Stem Seal

01: Motor Takım Keçesiz - Subap Lastikli

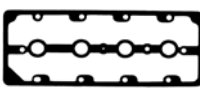
01: Gasket set With Valve Stem Seal Without Oil Seals

02: Motor Full Takım Keçeli ve Subap Lastikli

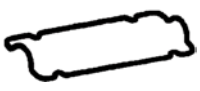
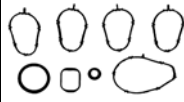
02: Gasket Full Set With oil seals and Valve Stem Seals

Subap Kapak Valve Cover Gasket Zylinderkopfhaube Couvre-culbut.	Karter Oil Pan Ölwanne Carter d'huile	Emme Manifold Intake Manifold Ansaug Admission	Egzoz Manifold Exhaust Manifold Auspuffkrümmer Collecteur D'echappement	Eksoz Boğaz Exhaust Pipe Auspuff Kehle	Supap Keçesi Valve Stem Seal Ventilschaft Queue de soupape	
						
 <b>60340025</b> 7688450		 <b>60340019</b> 46426046 46754320  <b>60340018</b> 46432735	 <b>60340020x2</b> 7749711	 <b>60340017</b> 7706480	 <b>60116026x8</b> 5930415 <b>7x9,8/13.2x10</b>	<b>21208003</b> 30x42x7 RD <b>21201072</b> 23x35x7 RD <b>21204081</b> 74x88x8 LD
 <b>62427925</b> 55194045		 <b>62427918</b> 71729223	 <b>62427921</b> 7749710		 <b>62427426x16</b> 46470334 <b>6x8,8x11,7x9,5</b>	<b>21208048</b> 27x37x7 RD <b>21208049</b> 40x55x7 RD
 <b>60340025</b> 7688450		 <b>60340418</b> 71716684	 <b>60340020x2</b> 7749711		 <b>60116026x8</b> 5930415 <b>7x9,8/13.2x10</b>	<b>21208003</b> 30x42x7 RD <b>21201072</b> 23x35x7 RD <b>21208041</b> 74x88x8 LD

■ : Delik - Çentik

■ : Hole - Notch

■ : Trou - Entaille

NOT: Katalogdaki Orijinal Kodlar Referans Amacıyla Kullanılmıştır.Lütfen COTECH Kodlarını Kullanınız.  
Original codes used for reference only.Please use COTECH codes for orders.

00



01



02



03



04



Silindir Kapak  
Cylinder Head  
Zylinderkopf  
Joint de culasse



Ltr	MODEL	PS/KW	ENGINE/MOTOR		
1,2 1242	<b>4 CYL ø70,8</b> PALIO 06/98--> PUNTO 03/94-->09/99 PUNTO 03/94-->09/99 PUNTO 11/99--> PUNTO 60 08/95--> PUNTO 75 04/96--> SIENA 04/96--> CABRIO 05/95-->06/00 Fire SPI Inyección	73 PS / 54 KW 60 PS / 44 KW 60 PS / 44 KW 73 PS / 54 KW 60 PS / 44 KW 73 PS / 53 KW 73 PS / 53 KW 60 PS / 44 KW	178 E2.000 176 B1.000 176 B4.000 176 A8.000 176 B4.000 178 B5.000 176 B5.000 176 B4.000	<b>60340202</b> 5893660  <b>60340201</b> 5893660  <b>60340203</b> 5893663 5893661	 <b>60340005</b> 7640784 1,80mm <b>ø71,5</b>
1,2 1242	<b>4 CYL ø70,8</b> PALIO 02/02--> SIENA 02/02--> BRAVA 10/00-->10/01 BRAVO 10/00-->10/01 IDEA 09/99--> PUNTO 09/99--> STILO 09/99-->	80 PS / 59 KW 80 PS / 59 KW 80 PS / 59 KW 80 PS / 59 KW 80 PS / 59 KW 80 PS / 59 KW 80 PS / 59 KW	178 D7.055 178 D7.055 188 A5.000 188 A5.000 188 A5.000 188 A5.000 188 A5.000	<b>62427902</b> Motor Full Takım Gasket Full Set  <b>62427903</b> 71739160	 <b>62427905</b> 55197283 MLS <b>ø72</b>
1,2 1242	<b>4 CYL ø70,8</b> PANDA 10/07--> PANDA (169) PUNTO / GRANDE PUNTO PUNTO EVO 500 500 C	69 PS / 51 KW	169 A.4000	<b>62428002</b> Motor Full Takım Gasket Full Set  <b>62428003</b> 71740655  <b>62428004</b> 71728839	 <b>62428005</b> 55183371 MLS <b>ø72</b>
1,3 125	<b>4 CYL ø72</b> 1961-->1966			<b>63110002</b> Motor Full Takım Gasket Full Set  <b>63110000</b>	 <b>63110005</b> 1,20mm  <b>63110006</b> 1,80mm <b>ø76</b>

▲ : İçerikte Bulunmamaktadır...

▲ : Not included in the set

▲ : Non inclus dans la pochette

00: Motor Takım Keçesiz ve Subap Lastiksiz











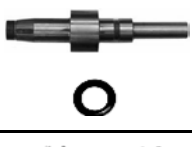
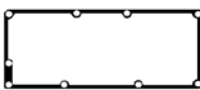





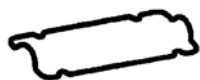





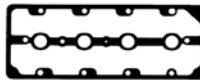
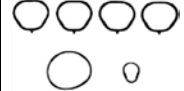

00: Gasket Set Without oil seals Without Valve Stem Seal

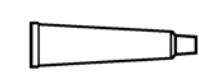
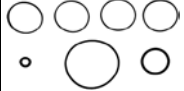
01: Motor Takım Keçesiz - Subap Lastikli

01: Gasket set With Valve Stem Seal Without Oil Seals

02: Motor Full Takım Keçeli ve Subap Lastikli

02: Gasket Full Set With oil seals and Valve Stem Seals

Subap Kapak Valve Cover Gasket Zylinderkopfhaube Couvre-culbut.	Karter Oil Pan Ölwanne Carter d'huile	Emme Manifold Intake Manifold Ansaug Admission	Egzoz Manifold Exhaust Manifold Auspuffkrümmer Collecteur D'echappement	Eksoz Boğaz Exhaust Pipe Auspuff Kehle	Supap Keçesi Valve Stem Seal Ventilschaft Queue de soupape	
						
 <b>60340025</b> 7688450		 <b>60340019</b> 46426046 46754320  <b>60340018</b> 46432735	 <b>60340020x2</b> 7749711	 <b>60340017</b> 7706480	 <b>60116026x8</b> 5930415 <b>7x9,8/13.2x10</b>	<b>21208003</b> 30x42x7 RD <b>21201072</b> 23x35x7 RD <b>21204081</b> 74x88x8 LD
 <b>62427925</b> 55194045		 <b>62427918</b> 71729223	 <b>62427921</b> 46526271		 <b>62427426x16</b> 46470334 <b>6x8,8x11,7x9,5</b>	<b>21208048</b> 27x37x7 RD <b>21208049</b> 40x55x7
 <b>62428025</b> 71740678	 <b>62427465</b>	 <b>62428019</b> 77363787	 <b>62428020</b> 55199355		 <b>62428027x8</b> 55190344 <b>5x7,8/11x8</b>	<b>21208049</b> 40x55x7 <b>21208048</b> 27x37x7 RD <b>21208050</b> 74x88x8 LD
 <b>60305034</b> 4027732	 <b>60305013</b> 902072	 <b>60305018x2</b> 4086677	 <b>60305020</b> 4072291	 <b>60305017</b> 4061096		<b>21201070</b> 45x62x8 <b>21201071</b> 80x100x10

■ : Delik - Çentik

■ : Hole - Notch

■ : Trou - Entaille

NOT: Katalogdaki Orijinal Kodlar Referans Amacıyla Kullanılmıştır.Lütfen COTECH Kodlarını Kullanınız.  
Original codes used for reference only.Please use COTECH codes for orders.

00



01



02



03









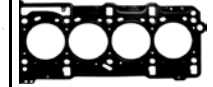

04



Silindir Kapak  
Cylinder Head  
Zylinderkopf  
Joint de culasse



Ltr	MODEL	PS/KW	ENGINE/MOTOR		
1,3 1242	<b>4 CYL ø69,6</b> DOBLO 06/03--> DOBLO D DOBLO JTD 16V FIORINO GRANDE PUNTO D GRANDE PUNTO (199) IDEA JTD PALIO PANDA PANDA JTD PUNTO PUNTO EVO PUNTO JTD 16V SIENA 500 500 C DOBLO 10/05--> DOBLO D GRANDE PUNTO D IDEA LINEA PUNTO / GRANDE PUNTO PUNTO EVO STRADA	75 PS / 55 KW 69 PS / 51 KW              90 PS / 66 KW 84 PS / 62 KW	169 A1.000 188 A9.000 199 A2.000              199 A3.000 223 A9.000	<b>62427402</b> Motor Full Takım Gasket Full Set     <b>62427403</b> 71729499 71744288    <b>62427404</b> 71736913 71744287  	 <b>62427505</b> 55209070 <b>0,72mm</b>  <b>62427506</b> 55209071 0,82mm 1   <b>62427507</b> 55209072 0,92mm 2  <b>MLS</b> <b>ø70,5</b>
1,3 1290	<b>4 CYL ø86,4</b> 128 09/71-->02/76 128 08/74-->12/81 128 12/74-->10/82 128 06/75->12/79 1,3 RITMO 01/78-->09/82 1301 RITMO 01/81-->09/82 RITMO 1978--> STRADA 01/78-->09/82 STRADA 01/81-->09/82	67 PS / 49 KW 60 PS / 44 KW 73 PS / 54 KW 65 PS / 48 KW 65 PS / 48 KW 75 PS / 55 KW 65 PS / 48 KW 65 PS / 48 KW 75 PS / 55 KW	128 A1. 128 A1. 128 A1.000 128 AC.000 138 A1.000 138 A3.000 128 A5.000 138 A1.000 138 A3.000	<b>60307002</b> 5881127  <b>60307000</b> 5881127	 <b>60307005</b> 4448401 1,20mm  <b>60307006</b> 4420365 5891281 1,80mm <b>ø87,5</b>

▲ : İçerikte Bulunmamaktadır...

▲ : Not included in the set

▲ : Non inclus dans la pochette

00: Motor Takım Keçesiz ve Subap Lastiksiz











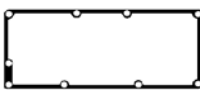

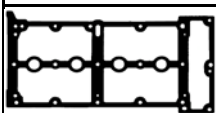
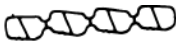

00: Gasket Set Without oil seals Without Valve Stem Seal

01: Motor Takım Keçesiz - Subap Lastikli

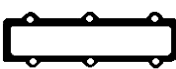
01: Gasket set With Valve Stem Seal Without Oil Seals

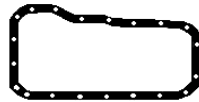
02: Motor Full Takım Keçeli ve Subap Lastikli

02: Gasket Full Set With oil seals and Valve Stem Seals

Subap Kapak Valve Cover Gasket Zylinderkopfhaube Couvre-culbut.	Karter Oil Pan Ölwanne Carter d'huile	Emme Manifold Intake Manifold Ansaug Admission	Egzoz Manifold Exhaust Manifold Auspuffkrümmer Collecteur D'echappement	Eksoz Boğaz Exhaust Pipe Auspuff Kehle	Supap Keçesi Valve Stem Seal Ventilschaft Queue de soupape	
						
 <b>62427425</b> 56 07 842		 <b>62427417</b> 58 50 674	 <b>62427421</b> 849 219		 <b>62427426x16</b> 1 547 971 6x8,8x11,7x9,5	<b>21204023</b> 40x52x7 RD <b>21204034</b> 78X100X9 RD
 <b>60304034</b> 4448677  <b>60304035</b> 7784728	 <b>60306013</b> 4179038	 <b>60306020x2</b> 4309031		 <b>60301018</b> 4147260	 <b>60107027x8</b> 7553637 8x10,8x14,2x10	<b>21201006</b> 30x52x7 RD <b>21201017</b> 40x56x7 RD <b>21201030</b> 64x80x8 LD

■ : Delik - Çentik

■ : Hole - Notch

■ : Trou - Entaille

NOT: Katalogdaki Orijinal Kodlar Referans Amacıyla Kullanılmıştır.Lütfen COTECH Kodlarını Kullanınız.  
Original codes used for reference only.Please use COTECH codes for orders.

00



Silindir Kapak

Cylinder Head

01



Zylinderkopf

02



Joint de culasse

03



04



Ltr	MODEL	PS/KW	ENGINE/MOTOR		
1,3 1290	<b>4 CYL ø86,4</b> 128 09/71-->02/76 128 08/74-->12/81 128 12/74-->10/82 128 06/75->12/79 1,3 RITMO 01/78-->09/82 1301 RITMO 01/81-->09/82 RITMO 1978--> STRADA 01/78-->09/82 STRADA 01/81-->09/82  65 L-CL Pick-Up Todos Tipos Motor All Engine Types Tous Types de Moteur	67 PS / 49 KW 60 PS / 44 KW 73 PS / 54 KW 65 PS / 48 KW 65 PS / 48 KW 75 PS / 55 KW 65 PS / 48 KW 65 PS / 48 KW 75 PS / 55 KW	128 A1. 128 A1. 128 A1.000 128 AC.000 138 A1.000 138 A3.000 128 A5.000 138 A1.000 138 A3.000	60307102+ 60307006  60307100+ 60307006	 <b>60307005</b> 4448401 1,20mm  <b>60307006</b> 4420365 5891281 1,80mm <b>ø87,5</b>
1,3 1301	<b>4 CYL ø86,4</b> REGATA 09/83-->07/89 REGATA 09/83-->07/89 RITMO 09/83-->07/89 RITMO 09/83-->07/89 RITMO 1982-->1986 UNO 05/85-->08/89 UNO 05/85-->08/89  70 S 85 S Automático Automatic S/SX/ELX	65 PS / 48 KW 65 PS / 48 KW 65 PS / 48 KW 65 PS / 48 KW 82 PS / 60 KW 65 PS / 48 KW 65 PS / 48 KW	149 A3.000 149 A7.000 149 A3.000 149 A7.000 138 B2.000 149 A7.000 149 A3.000	62426202 5882782  62426201 5882782	 <b>62426105</b> 7679380 1,80mm <b>ø87</b>
1,3 1297	<b>4 CYL ø76</b> 131 10/74-->12/81  C - L - S Mirafiori	54 PS / 50 KW 55 PS / 40 KW 78 PS / 57 KW	131 A6.000 131 B.000	60302002 5880442  60302001 5880442	 <b>60302005</b> 7387620 1,20mm  <b>60302006</b> 7387620 1,80mm <b>ø78</b>

▲ : İçerikte Bulunmamaktadır...

▲ : Not included in the set

▲ : Non inclus dans la pochette

00: Motor Takım Keçesiz ve Subap Lastiksiz











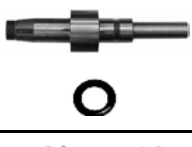
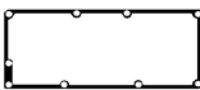





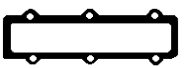



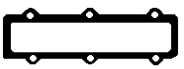

00: Gasket Set Without oil seals Without Valve Stem Seal

01: Motor Takım Keçesiz - Subap Lastikli

01: Gasket set With Valve Stem Seal Without Oil Seals

02: Motor Full Takım Keçeli ve Subap Lastikli

02: Gasket Full Set With oil seals and Valve Stem Seals

Subap Kapak Valve Cover Gasket Zylinderkopfhaube Couvre-culbut.	Karter Oil Pan Ölwanne Carter d'huile	Emme Manifold Intake Manifold Ansaug Admission	Egzoz Manifold Exhaust Manifold Auspuffkrümmer Collecteur D'echappement	Eksoz Boğaz Exhaust Pipe Auspuff Kehle	Supap Keçesi Valve Stem Seal Ventilschaft Queue de soupape	
						
 <b>60304034</b> 4448677	 <b>60306013</b> 4179038	 <b>60306020x2</b> 4309031		 <b>60301018</b> 4147260	 <b>60107027x8</b> 7553637 8x10,8x14,2x10	<b>21201006</b> 30x52x7 RD
 <b>60304035</b> 7784728						<b>21201017</b> 40x56x7 RD
						<b>21201030</b> 64x80x8 LD
 <b>60304034</b> 4448677	 <b>60306013</b> 4179038	 <b>60306020x2</b> 4309031		 <b>60301018</b> 4147260	 <b>60107027x8</b> 7553637 8x10,8x14,2x10	<b>21201006</b> 30x52x7 RD
 <b>60304035</b> 7784728						<b>21201017</b> 40x56x7 RD
						<b>21201030</b> 64x80x8 LD
 <b>60301034</b> 4130541	 <b>60303013</b> 4331606	 <b>60302020x2</b> 4336357		 <b>60301018</b> 4147260	 <b>60107027x8</b> 7553637 8x10,8x14,2x10	<b>21201006</b> 30x52x7 RD
						<b>21201017</b> 40x56x7 RD
						<b>21201066</b> 70x90x10 LD

■ : Delik - Çentik

■ : Hole - Notch

■ : Trou - Entaille

NOT: Katalogdaki Orijinal Kodlar Referans Amacıyla Kullanılmıştır.Lütfen COTECH Kodlarını Kullanınız.  
Original codes used for reference only.Please use COTECH codes for orders.

00



Silindir Kapak

Cylinder Head

01



Zylinderkopf

02



Joint de culasse

03



04

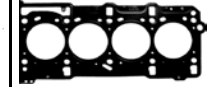

Ltr	MODEL	PS/KW	ENGINE/MOTOR		
1,4 1372	<b>4 CYL ø80,5</b> TIPO 05/1989-->04/1995 TIPO 07/1987-->12/1989 TIPO 07/1987-->12/1989 TIPO 05/1989-->04/1995 UNO 09/1989-->12/1993 UNO 09/1989-->12/1993 UNO 1989-->1993 TEMPRA 10/89-->05/95 TEMPRA 1990-->1993 TEMPRA 10/92-->08/96 TEMPRA 10/92-->08/96 FIORINO 10/89-->05/95 FIORINO 10/89-->05/95 PALIO 04/96--> PALIO 04/96--> SIENA 04/96--> SIENA 04/96-->  Furgoneta i.e. S.W.	69 PS / 51 KW 71 PS / 52 KW 71 PS / 52 KW 78 PS / 57 KW 70 PS / 51 KW 72 PS / 53 KW 72 PS / 53 KW 69 PS / 51 KW 72 PS / 53 KW 69 PS / 51 KW 69 PS / 51 KW 69 PS / 51 KW 67 PS / 49 KW 67 PS / 49 KW 69 PS / 51 KW 69 PS / 51 KW 69 PS / 51 KW 69 PS / 51 KW	836 A4.000 160 A1.048 160 A1.000 160 A1.046 160 A1.046 146 C1.000 146 C1.0000 160 A1.046 159 A2.000 160 A1.046 836 A4.000 146 C5.000 146 D5.000 178 B2.000 178 B2.016 178 B2.000 178 B2.016	<b>60314002</b> 5892410  <b>60314001</b> 5892410  <b>60314003</b> 5888262	 <b>60314005</b> 7666858 1,80mm <b>ø81</b>
1,4 1368	<b>4 CYL ø72</b> IDEA 01/04-->04/06 STILO 01/04-->04/06 PANDA 10/06--> 500 500 C	90 PS / 66 KW 90 PS / 66 KW 100 PS / 74 KW	192 B2.000 843 A1.000 169 A3.000		 <b>62427905</b> 55197283 MLS <b>ø72</b>
1,4 1368	<b>4 CYL ø72</b> DOBLO 10/05--> FIORINO GRANDE PUNTO IDEA LINEA PANDA PUNTO / GRANDE PUNTO PUNTO EVO QUBO	78 PS / 57 KW 77 PS / 57 KW	350 A1.000	<b>62428002</b> Motor Full Takım Gasket Full Set  <b>62428003</b> 71740655  <b>62428004</b> 71728839	 <b>62428005</b> 55183371 MLS <b>ø72</b>

▲ : İçerikte Bulunmamaktadır...

▲ : Not included in the set

▲ : Non inclus dans la pochette

00: Motor Takım Keçesiz ve Subap Lastiksiz











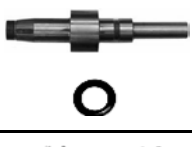
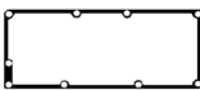



00: Gasket Set Without oil seals Without Valve Stem Seal

01: Motor Takım Keçesiz - Subap Lastikli

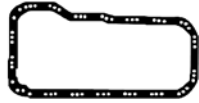
01: Gasket set With Valve Stem Seal Without Oil Seals

02: Motor Full Takım Keçeli ve Subap Lastikli

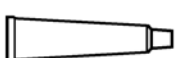
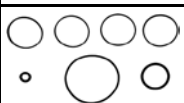
02: Gasket Full Set With oil seals and Valve Stem Seals

Subap Kapak Valve Cover Gasket Zylinderkopfhaube Couvre-culbut.	Karter Oil Pan Ölwanne Carter d'huile	Emme Manifold Intake Manifold Ansaug Admission	Egzoz Manifold Exhaust Manifold Auspuffkrümmer Collecteur D'echappement	Eksoz Boğaz Exhaust Pipe Auspuff Kehle	Supap Keçesi Valve Stem Seal Ventilschaft Queue de soupape	
						
 <b>60304034</b> 7797034	 <b>60304013</b> 7554363 76663366	 <b>60304020</b> 7772495			 <b>60107027x8</b> 7553637 8x10,8/14,2x10	<b>21201006x2</b> 30x52x7 RD
 <b>60304035</b> 7784728						<b>21201017</b> 40x56x7 RD <b>21201030</b> 64x80x8 LD
 <b>62428025</b> 71740678	 <b>62427465</b>	 <b>62428019</b> 77363787	 <b>62428020</b> 55199355		 <b>62428027x8</b> 55190344 5x7,8/11x8	<b>21208049</b> 40x55x7 <b>21208048</b> 27x37x7 RD <b>21208050</b> 74x88x8 LD

■ : Delik - Çentik

■ : Hole - Notch

■ : Trou - Entaille

NOT: Katalogdaki Orjinal Kodlar Referans Amacıyla Kullanılmıştır.Lütfen COTECH Kodlarını Kullanınız.  
Original codes used for reference only.Please use COTECH codes for orders.

00



Silindir Kapak  
Cylinder Head

01



Zylinderkopf

02



Joint de culasse

03



04

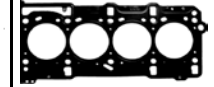

Ltr	MODEL	PS/KW	ENGINE/MOTOR		
1,4 1438	<b>4 CYL ø80</b> 124 01/66-->10/72 124 SPECIAL T 124 SPORT 124 COUPE	90 PS / 66 KW	124 AC.000 124 B2.000	<b>60312002</b> 5880432 <b>60312000</b> 5880432	 <b>60312005</b> 4387612 1,40mm <b>60312006</b> 4315064 1,80mm <b>ø81</b>
1,4 1367	<b>4 CYL ø78</b> 131 MIRAFIORI 1984--> L / CL			<b>63116002</b> <b>63116000</b>	 <b>63116005</b> 4434953 1,60mm <b>ø80</b>
1,4 1438	<b>4 CYL ø80</b> 124 12/68-->12/72 124 01/73-->07/75 Special	70 PS / 51 KW 75 PS / 55 KW	124 B2.000 124 B2.000	<b>63115002</b> 5880430 <b>63115000</b> 5880430	 <b>63115005</b> 4387613 1,40mm <b>63115006</b> 4137856 1,80mm <b>ø81</b>
1,5 1498	<b>4 CYL ø86,4</b> FIORINO 01/78-->10/82 RITMO 01/78-->10/82 STRADA 01/78-->10/82 75 C-CL Furgoneta Pick-Up S75	75 PS / 55 KW	138 B 18 A4	<b>60307002</b> 5881127 <b>60307000</b> 5881127	 <b>60307005</b> 4448401 1,20mm <b>60307006</b> 4420365 5891281 1,80mm <b>ø87,5</b>

▲ : İçerikte Bulunmamaktadır...

▲ : Not included in the set

▲ : Non inclus dans la pochette

00: Motor Takım Keçesiz ve Subap Lastiksiz











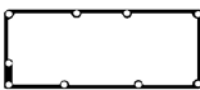







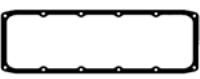

00: Gasket Set Without oil seals Without Valve Stem Seal

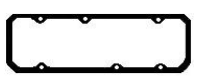
01: Motor Takım Keçesiz - Subap Lastikli

01: Gasket set With Valve Stem Seal Without Oil Seals

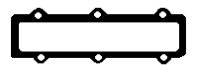
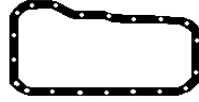
02: Motor Full Takım Keçeli ve Subap Lastikli

02: Gasket Full Set With oil seals and Valve Stem Seals

Subap Kapak Valve Cover Gasket Zylinderkopfhaube Couvre-culbut.	Karter Oil Pan Ölwanne Carter d'huile	Emme Manifold Intake Manifold Ansaug Admission	Egzoz Manifold Exhaust Manifold Auspuffkrümmer Collecteur D'echappement	Eksoz Boğaz Exhaust Pipe Auspuff Kehle	Supap Keçesi Valve Stem Seal Ventilschaft Queue de soupape	
						
60308035x2 4388512	60301013 4129756	60308018 4194060	60308020 4177112 7709259	60308017 4166914	60107027x8 7553637 8x10,8/14,2x10	21201006x2 30x52x7 RD
						21201017 40x56x7 RD
60308034x2 4158646						21201066 70x90x10 LD
						21201006 30x52x7 RD
63111035 5996632	60303013 4331606	63111020 4462674		60301018 4147260		21201017 40x56x7 LD
						21201066 70x90x10 RD
						21201017 40x56x7 LD
60301034 4130541	60301013 4129756	60301020x2 4177631		60301018 4147260	60107027x8 7553637 8x10,8x14,2x10	21201066 70x90x10 RD
						21201006x2 30x52x7 RD
40304034 4448677	60306013 4179038	60306020x2 4309031		60301018 4147260	60107027x8 7553637 8x10,8x14,2x10	21201017 40x56x7 RD
						21201030 64x80x8 LD
60304035 7784728						

■ : Delik - Çentik

■ : Hole - Notch

■ : Trou - Entaille

NOT: Katalogdaki Orjinal Kodlar Referans Amacıyla Kullanılmıştır.Lütfen COTECH Kodlarını Kullanınız.  
Original codes used for reference only.Please use COTECH codes for orders.

00



Silindir Kapak  
Cylinder Head

01



Zylinderkopf

02



Joint de culasse

03



04



Ltr	MODEL	PS/KW	ENGINE/MOTOR		
1,5 1481	<b>4 CYL ø77</b> 1500 L 1500 C	07/62-->03/69 10/63-->12/70	102 PS / 75 KW 72 PS / 53 KW	115 000	<b>60305000</b> 900980 <b>60305005</b> 4056553 1,40mm <b>60305006</b> 4113043 ø78,5
1,5	<b>4 CYL 125</b>				<b>63112000</b> <b>63112005</b> 1,20mm <b>63112006</b> 1,80mm ø81
1,6 1585	<b>4 CYL ø84</b> 131 MIRAFIORI CL 1600	1982-->			<b>63111002</b> <b>63111000</b> <b>63111005</b> 5891304 1,70mm ø85
1,6 1581	<b>4 CYL ø86,4</b> TEMPRA TEMPRA TEMPRA TIPO TIPO TIPO FIORINO FIORINO STRADA SCUDO PALIO Furgoneta i.e. Pick-Up S.W. S/SX/ELX	06/92-->08/96 06/92-->08/96 1990-->1993 1989-->1995 10/92-->04/95 10/92-->04/95 10/93-->12/97 10/93-->12/97 06/99--> 02/96--> 1996-->1997	75 PS / 55 KW 75 PS / 55 KW 84 PS / 62 KW 84 PS / 62 KW 75 PS / 55 KW 75 PS / 55 KW 75 PS / 55 KW 75 PS / 55 KW 75 PS / 55 KW 79 PS / 58 KW 82 PS / 60 KW	159 A3.048 835 C1.000 M202PA.15.0 M202PA.15.0 159 A3.048 835 C1.000 146 C.6000 146 D.6000 1580 MPI 220 A2.000 178 B3.000	<b>60304002</b> 5890649 <b>60304001</b> <b>60304003</b> 5888319 <b>60304005</b> 46414567 1,80mm ø87

▲ : İçerikte Bulunmamaktadır...

▲ : Not included in the set

▲ : Non inclus dans la pochette

00: Motor Takım Keçesiz ve Subap Lastiksiz











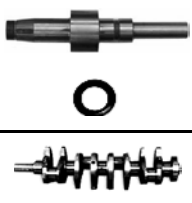
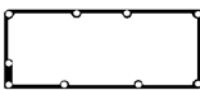













00: Gasket Set Without oil seals Without Valve Stem Seal

01: Motor Takım Keçesiz - Subap Lastikli

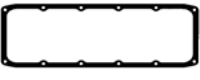
01: Gasket set With Valve Stem Seal Without Oil Seals

02: Motor Full Takım Keçeli ve Subap Lastikli

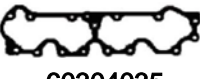
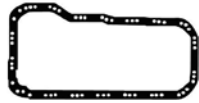
02: Gasket Full Set With oil seals and Valve Stem Seals

Subap Kapak Valve Cover Gasket Zylinderkopfhaube Couvre-culbut.	Karter Oil Pan Ölwanne Carter d'huile	Emme Manifold Intake Manifold Ansaug Admission	Egzoz Manifold Exhaust Manifold Auspuffkrümmer Collecteur D'echappement	Eksoz Boğaz Exhaust Pipe Auspuff Kehle	Supap Keçesi Valve Stem Seal Ventilschaft Queue de soupape	
						
 60305034 4027732	 60305013 902072	 60305016x2 4086669  60305018x2 4086677	 60305020 4072291	 60305017 4061096		
 60305034 4027732	 60305013 902072	 60305016x2 4086669  60305018x2 4086677	 60305020 4072291	 60305017 4061096		
 63111035 5996632	 60303013 4331606	 63111020 4462674		 60301018 4147260		21201006 30x52x7 RD 21201017 40x56x7 LD 21201066 70x90x10 RD
 60304034 7797034  60304035 7784728	 60304013 7554363 7663366	 60304020 7772495			 60107027x8 0956.22 8x10,8/14,2x10	21201006x2 30x52x7 RD 21201017 40x56x7 RD 21201030 64x80x8 LD

■ : Delik - Çentik

■ : Hole - Notch

■ : Trou - Entaille

NOT: Katalogdaki Orjinal Kodlar Referans Amacıyla Kullanılmıştır.Lütfen COTECH Kodlarını Kullanınız.  
Original codes used for reference only.Please use COTECH codes for orders.

00



01



02



03



04



Silindir Kapak  
Cylinder Head  
Zylinderkopf  
Joint de culasse

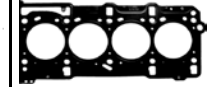

Ltr	MODEL	PS/KW	ENGINE/MOTOR		
1,6 1581	<b>4 CYL ø86,4</b> MAREA 09/99--> MAREA 09/99--> MAREA 09/99--> BRAVA 10/95-->10/01 BRAVO 09/99--> MULTIPLA 04/99--> MULTIPLA 04/99--> MULTIPLA 04/99--> MULTIPLA 04/96--> MULTIPLA 04/99--> PALIO 04/96--> PALIO 04/96--> PALIO 04/96--> SCUDO 1995--> SIENA 09/98--> SIENA 16 V	103 PS / 76 KW 103 PS / 76 KW 103 PS / 76 KW 90 PS / 66 KW 90 PS / 66 KW 103 PS / 76 KW 103 PS / 76 KW 103 PS / 76 KW 103 PS / 76 KW 95 PS / 70 KW 100 PS / 74 KW 95 PS / 67 KW 103 PS / 76 KW 103 PS / 76 KW 92 PS / 68 KW 103 PS / 76 KW	182 A4.000 185 A3.000 182 B5.098 182 A6.000 182 A6.000 186 A4.000 182 A4.000 186 A3.000 186 A4.000 186 A3.000 178 B3.000 182 A4.000 182 A6.000 182 178 D2.011 178 C7.098	<b>62423402</b> 71713032 5895664  <b>62423403</b> 5895663 71713031	 <b>62423405</b> 46410960 1,80mm <b>ø87</b>
1,6 1585	<b>4 CYL ø84</b> 131 MIRAFIORI 10/74-->09/81 242/15 10/75-->07/82  C-L-S	75 PS / 55 KW 63 PS / 46 KW	131 A1.000 124 B3.000	<b>60303002</b> 5880444 5880442  <b>60303000</b> 5880444 5880442	 <b>60303005</b> 5891273 1,60mm <b>ø85</b>
1,6 1585	<b>4 CYL ø84</b> 131 03/1973-->03/1982 131 01/1978-->06/1985 131 01/1978-->06/1985 132 01/1976-->12/1982 132 03/1977-->12/1981 Argento 04/1981-->12/1985 Argento 04/1981-->12/1985 Ritmo 05/1981-->12/1982 Berlina  131 -->1982 132 01/78-->05/82 REGATA 100 RITMO STRADA 131 SUPERMIRAFIORI  Sport Super	98 PS / 72 KW 85 PS / 63 KW 97 PS / 71 KW 98 PS / 72 KW 90 PS / 66 KW 98 PS / 72 KW 90 PS / 66 KW 105 PS / 77 KW  98 PS / 72 KW 118 PS / 86 KW	131 B1.000 131 C2.000 131 C3.000 132 C.000 132 C6.000 132 D.000 132 A 138 AR.000  TC 2ACT	<b>60309002</b> 5880452  <b>60309000</b> 5880452	 <b>60309005</b> 4387624 1,40mm  <b>60309006</b> 5951675 1,80mm <b>ø85</b>

▲ : İçerikte Bulunmamaktadır...

▲ : Not included in the set

▲ : Non inclus dans la pochette

00: Motor Takım Keçesiz ve Subap Lastiksiz











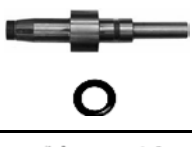
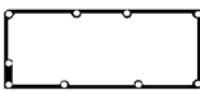













00: Gasket Set Without oil seals Without Valve Stem Seal

01: Motor Takım Keçesiz - Subap Lastikli

01: Gasket set With Valve Stem Seal Without Oil Seals

02: Motor Full Takım Keçeli ve Subap Lastikli

02: Gasket Full Set With oil seals and Valve Stem Seals

Subap Kapak Valve Cover Gasket Zylinderkopfhaube Couvre-culbut.	Karter Oil Pan Ölwanne Carter d'huile	Emme Manifold Intake Manifold Ansaug Admission	Egzoz Manifold Exhaust Manifold Auspuffkrümmer Collecteur D'echappement	Eksoz Boğaz Exhaust Pipe Auspuff Kehle	Supap Keçesi Valve Stem Seal Ventilschaft Queue de soupape	
						
 62423434x2 7773831 46467203	 60304013 7554363 7663366	 62423419 46410505  62423415x4 46402220	 62423420 46412116		 62423427x16 7581344 7x9.8x13,2x10	21201006x2 30x52x7 RD 21201017 40x56x7 RD 21201030 64x80x8 LD
 60301034 4130541	 60303013 4331606	 60302020x2 4336357		 60301018 4147260	 60107027x8 7553637 8x10,8/14,2x10	21201006 30x52x7 RD 21201017 40x56x7 LD 21201066 70x90x10 RD
 60308035x2 4388512  60308034x2 4158646	 60303013 4331606	 60308018 4194060	 60308020 4177112 7709259	 60308017 4166914	 60107027x8 7553637 8x10,8/14,2x10	21201006x2 30x52x7 RD 21201017 40x56x7 RD 21201066 70x90x10 LD

■ : Delik - Çentik

■ : Hole - Notch

■ : Trou - Entaille

NOT: Katalogdaki Orijinal Kodlar Referans Amacıyla Kullanılmıştır.Lütfen COTECH Kodlarını Kullanınız.  
Original codes used for reference only.Please use COTECH codes for orders.

00



Silindir Kapak  
Cylinder Head

01



Zylinderkopf

02



Joint de culasse

03



04

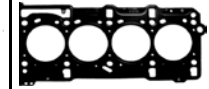

Ltr	MODEL	PS/KW	ENGINE/MOTOR		
1,6 1585	<b>4 CYL ø84</b> REGATA 12/87-->12/90 REGATA 01/87-->12/90 RITMO 02/88-->05/91 TIPO 02/88-->05/91	99 PS / 73 KW 99 PS / 73 KW 90 PS / 66 KW 90 PS / 66 KW	2 ACT M402AA.16.0 M402AA.16.0 149 C2.046		
				<b>60330005</b> 4314165 7604264 1,80mm ø85	
1,6 1592	<b>4 CYL ø80</b> 124 01/69-->12/75 124 01/69-->12/75 124 01/73-->07/75 124 11/69-->08/73 131 -->1976 132 -->1976 Special T Spider Sport Coupe	108 PS / 80 KW 104 PS / 76 KW 95 PS / 70 KW 100 PS / 74 KW 98 PS / 72 KW 98 PS / 72 KW	132 AC.000 132 AC.000 132AC 132 AC.000 828 828	<b>60308002</b> 5880448 <b>60308000</b> 5880448	
				<b>60308005</b> 4263871 1,20mm <b>60308006</b> 4263871 1,80mm ø82	
1,6 1596	<b>4 CYL ø80</b> MAREA 09/00-->08/02 PALIO 02/01--> ALBEA 11/00--> STILO 10/01-->08/08	103 PS / 76 KW 103 PS / 76 KW 103 PS / 76 KW 103 PS / 76 KW	182 B6.000 182 B6.000 182 B6.000 182 B6.000		
				<b>61506005</b> 55187650 46752127 1,80mm ø81	
1,6 1598	<b>4 CYL ø79,5</b> DOBLO 02/10--> LINEA 06/09--> IDEA 05/08--> IDEA 05/08--> BRAVO 09/08--> JTD 16 V	101 PS / 74 KW 105 PS / 77 KW 120 PS / 88 KW 120 PS / 88 KW 105 PS / 77 KW	263 A3.000 198 A3.000 198 A3.000 350 A2.000 198 A3.000 198 A1.000 198 A2.000	<b>62427602</b> Motor Full Takım Gasket Full Set  <b>62427603</b> 71769851  <b>62427604</b> 71749743	
				<b>62427605</b> 55221093 0,82mm <b>62427606</b> 55221094 0,92mm 1 <b>62427607</b> 55221095 1,02mm 2 MLS ø80,5	

▲ : İçerikte Bulunmamaktadır...

▲ : Not included in the set

▲ : Non inclus dans la pochette

00: Motor Takım Keçesiz ve Subap Lastiksiz











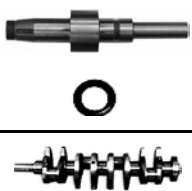
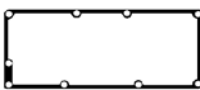







00: Gasket Set Without oil seals Without Valve Stem Seal

01: Motor Takım Keçesiz - Subap Lastikli

01: Gasket set With Valve Stem Seal Without Oil Seals

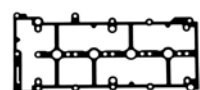
02: Motor Full Takım Keçeli ve Subap Lastikli

02: Gasket Full Set With oil seals and Valve Stem Seals

Subap Kapak Valve Cover Gasket Zylinderkopfhaube Couvre-culbut.	Karter Oil Pan Ölwanne Carter d'huile	Emme Manifold Intake Manifold Ansaug Admission	Egzoz Manifold Exhaust Manifold Auspuffkrümmer Collecteur D'echappement	Eksoz Boğaz Exhaust Pipe Auspuff Kehle	Supap Keçesi Valve Stem Seal Ventilschaft Queue de soupape	
						
 60308035x2 4388512  60308034x2 4158646	 60301013 4129756	 60308018 4194060	 60308020 4177112 7709259	 60308017 4166914	 60107027x8 7553637 8x10,8/14,2x10	21201006x2 30x52x7 RD 21201017 40x56x7 RD 21201066 70x90x10 LD
 62427625 55205111		 62427618 71754211	 62427621 55210879		 62427626x16 55183812 5x10x23,4x15,5	21201100 31x41x7 RD 21201101 30x45x7 RD

■ : Delik - Çentik

■ : Hole - Notch

■ : Trou - Entaille

NOT: Katalogdaki Orjinal Kodlar Referans Amacıyla Kullanılmıştır.Lütfen COTECH Kodlarını Kullanınız.  
Original codes used for reference only.Please use COTECH codes for orders.

FIAT

00



01



02



03







04



Silindir Kapak  
Cylinder Head  
Zylinderkopf  
Joint de culasse



Ltr	MODEL	PS/KW	ENGINE/MOTOR			
1,6 1598	<b>4 CYL ø75</b> SCUDO JTD 16 V	01/07-->	90 PS / 66 KW	9HU	<p><b>61707002</b> Motor Full Takım Gasket Full Set</p>  <p><b>61707003</b> Motor Üst Takım Gasket Head Set</p>  <p><b>61707004</b> Motor Alt Takım Conversion Set</p>	 <p><b>61707005</b> 0209.CG 1,45mm 5</p> <p><b>61707006</b> 0209.CF 1,40mm 4</p> <p><b>61707007</b> 0209.CC 1,30mm 3</p> <p><b>61707008</b> 0209.CA 1,25mm 2</p> <p><b>61707009</b> 0209.CE 1,35mm 1 MLS ø76</p>
1,6 1608	<b>4 CYL ø80</b> 124 124 124 124 125 Special Sport Coupe Speyder	06/67-->10/72 06/67-->10/72 06/67-->10/72 06/67-->10/72 06/68-->12/72	90 PS / 66 KW 90 PS / 66 KW 90 PS / 66 KW 90 PS / 66 KW 100 PS / 74 KW	124 AC.000 125A 125B 125C 125C	<p><b>60312002</b> 5880432</p> <p><b>60312000</b> 5880432</p>  <p><b>60312005</b> 4387612 1,40mm</p> <p><b>60312006</b> 4315064 1,80mm ø81</p>	

▲ : İçerikte Bulunmamaktadır...

▲ : Not included in the set

▲ : Non inclus dans la pochette

00: Motor Takım Keçesiz ve Subap Lastiksiz











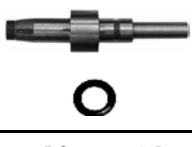
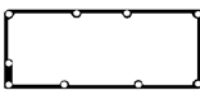





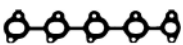

00: Gasket Set Without oil seals Without Valve Stem Seal

01: Motor Takım Keçesiz - Subap Lastikli

01: Gasket set With Valve Stem Seal Without Oil Seals

02: Motor Full Takım Keçeli ve Subap Lastikli

02: Gasket Full Set With oil seals and Valve Stem Seals

Subap Kapak Valve Cover Gasket Zylinderkopfhaube Couvre-culbut.	Karter Oil Pan Ölwanne Carter d'huile	Emme Manifold Intake Manifold Ansaug Admission	Egzoz Manifold Exhaust Manifold Auspuffkrümmer Collecteur D'echappement	Eksoz Boğaz Exhaust Pipe Auspuff Kehle	Supap Keçesi Valve Stem Seal Ventilschaft Queue de soupape	
						
 <b>61707025</b> 0249.C2	 <b>62427465</b>	 0348.R5 x4  0348.R4 x4 <b>61707018</b> 0348.R5+0348.R4 SET	 <b>61706021</b> 0349.J8 0349.J7 0349.N0 1 148 115		 <b>61707026x16</b> 0956.51 <b>5,5x9,5x18,1x14</b>	<b>21204017</b> 27x47x7 RD <b>21204018</b> 40x55x6,4 LD <b>21204019</b> 85x105x8,8 RD
 <b>60308035x2</b> 4388512  <b>60308034x2</b> 4158646	 <b>60301013</b> 4129756	 <b>60308018</b> 4194060	 <b>60308020</b> 4177112 7709259	 <b>60308017</b> 4166914	 <b>60107027x8</b> 7553637 <b>8x10,8/14,2x10</b>	<b>21201006x2</b> 30x52x7 RD <b>21201017</b> 40x56x7 RD <b>21201066</b> 70x90x10 LD









■ : Delik - Çentik

■ : Hole - Notch

■ : Trou - Entaille

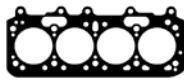
NOT: Katalogdaki Orijinal Kodlar Referans Amacıyla Kullanılmıştır.Lütfen COTECH Kodlarını Kullanınız.  
Original codes used for reference only.Please use COTECH codes for orders.



Ltr	MODEL	PS/KW	ENGINE/MOTOR		
1,7 1697	<b>4 CYL ø82,6</b> REGATA 05/85-->03/89 RITMO 05/85-->12/87 RITMO 05/85-->12/87 TIPO 07/86-->08/89 UNO 07/80-->08/89 DUNA 01/87-->12/91 FIORINO 05/85-->03/89	60 PS / 44 KW 60 PS / 44 KW 60 PS / 44 KW 60 PS / 44 KW 60 PS / 44 KW 60 PS / 44 KW 60 PS / 44 KW	149 B3.000 149 B3.000 138 C.000 149 B3.000 149 B3.000 149 B3.000 149 B3.000	<b>62423502</b> 5882358  <b>62423602</b> 5882358+5962713	 <b>62423505</b> 5962713 1,95mm 2  <b>62423506</b> 5962712 1,80mm 1  <b>62423507</b> 5962711 1,65mm ø83
1,7 1697	<b>4 CYL ø82,6</b> FIORINO 11/96-->05/01 FIORINO TD PALIO 01/94--> PALIO TD PUNTO TD SIENA STRADA TD PUNTO D 04/94-->02/00 STILO UNO  Diesel Pick-Up Turbo Diesel	63 PS / 46 KW 57 PS / 42 KW 72 PS / 53 KW 69 PS / 51 KW   57 PS / 42 KW	146 D7.000 149 B4.046 176 A3.000 176 A5.000   176 B3.000 178 C9.000	 <b>62426605</b> 46431642 1,95mm 2  <b>62426606</b> 46431640 1,80mm 1  <b>62426607</b> 7630180 1,65mm FIBER / FIBRE ø83,5	
1,8 1756	<b>4 CYL ø84</b> TEMPRA 03/92-->08/96 TIPO 10/90-->06/93 TIPO 10/90-->06/93 TIPO 03/93-->04/95 TEMPRA 08/93-->04/96 TIPO 03/93-->04/95 TIPO 03/93-->04/95 TEMPRA 08/93-->04/96	105 PS / 77 KW 105 PS / 77 KW 105 PS / 77 KW 90 PS / 60 KW 90 PS / 60 KW 97 PS / 71 KW 90 PS / 60 KW 97 PS / 71 KW	159 A4.046 159 A4.046 159 A4.000 836 C4.000 835 C4.000 836 A5.000 836 A6.000 836 A5.000	<b>62424001</b> 5893330  <b>62424005</b> 7660966 1,80mm ø85	

▲ : İçerikte Bulunmamaktadır...

▲ : Not included in the set

▲ : Non inclus dans la pochette

00: Motor Takım Keçesiz ve Subap Lastiksiz











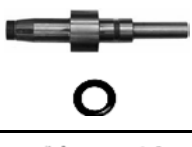
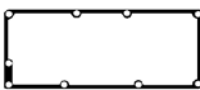

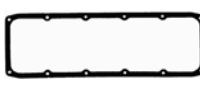

00: Gasket Set Without oil seals Without Valve Stem Seal

01: Motor Takım Keçesiz - Subap Lastikli

01: Gasket set With Valve Stem Seal Without Oil Seals

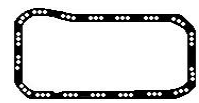
02: Motor Full Takım Keçeli ve Subap Lastikli

02: Gasket Full Set With oil seals and Valve Stem Seals

Subap Kapak Valve Cover Gasket Zylinderkopfhaube Couvre-culbut.	Karter Oil Pan Ölwanne Carter d'huile	Emme Manifold Intake Manifold Ansaug Admission	Egzoz Manifold Exhaust Manifold Auspuffkrümmer Collecteur D'echappement	Eksoz Boğaz Exhaust Pipe Auspuff Kehle	Supap Keçesi Valve Stem Seal Ventilschaft Queue de soupape	
						
						<b>21201006</b> 30x52x7 RD
<b>63111035</b> 4394109 7702774	<b>62423513</b> 7647596 7647596	<b>62423520</b> 4436580 7765454			<b>60107027x8</b> 7553637 8x10,8/14,2x10	<b>21208056</b> 30x43x8 RD
						<b>21201066</b> 70x90x10 LD
						
<b>60330034x2</b> 7660565	<b>62424013</b> 7646248	<b>60330019</b> 7700197	<b>60308020</b> 4368925		<b>60107027x8</b> 7553637 8x10,8/14,2x10	
						
<b>60331035x2</b> 7684064						

■ : Delik - Çentik

■ : Hole - Notch

■ : Trou - Entaille

NOT: Katalogdaki Orijinal Kodlar Referans Amacıyla Kullanılmıştır.Lütfen COTECH Kodlarını Kullanınız.  
Original codes used for reference only.Please use COTECH codes for orders.

00



01



02



03



04



Silindir Kapak  
Cylinder Head  
Zylinderkopf  
Joint de culasse



Ltr	MODEL	PS/KW	ENGINE/MOTOR		
1,8 1762	<b>4 CYL ø83</b> ULYSSE 05/97-->08/02 ULYSSE 05/97-->08/02	99 PS / 73 KW 99 PS / 73 KW	LFW XU7J	<b>61233002</b> 0197.G4+0209.E1	 <b>61207005</b> 0209.E1 1,30mm 1 <b>61207006</b> 0209.L8 1,50mm 2 <b>ø84,5</b>
1,8 1796	<b>4 CYL ø84</b> DUCATO 01/86-->10/88	67 PS / 49 KW	169 B 280/A14 280.A14.169B	<b>61210001</b> 0197.L1 0197.15	 <b>61210005</b> 0209.F8 <b>ø86,7</b>
1,8 1756	<b>4 CYL ø84</b> 124 01/73-->05/82 132 01/78-->05/82	114 PS / 84 KW 60 PS / 44 KW	132 A7.000 2ACT	<b>60309002</b> 5880452  <b>60309000</b> 5880452	 <b>60309005</b> 4387624 1,40mm <b>60309006</b> 5951675 1,80mm <b>ø85</b>
1,9 1905	<b>4 CYL ø83</b> DUCATO 04/98-->04/02 DUCATO 04/98-->04/02 SCUDO 04/98-->04/02 SCUDO 02/96-->	69 PS / 51 KW 69 PS / 51 KW 69 PS / 51 KW 69 PS / 51 KW	DJY D9B DHX(XUD9TF/L) D9B	<b>61204002</b> 95602514   <b>61204003</b> 95602513 	 <b>61204009</b> 0209.S5 1,36 mm 1 <b>61204008</b> 0209.S6 1,40 mm 2 <b>61204007</b> 0209.S7 1,44 mm 3 <b>61204006</b> 0209.S8 1,48 mm 4 <b>61204005</b> 0209.S9 1,53 mm 5 <b>ø 84</b>

▲ : İçerikte Bulunmamaktadır...

▲ : Not included in the set

▲ : Non inclus dans la pochette

00: Motor Takım Keçesiz ve Subap Lastiksiz











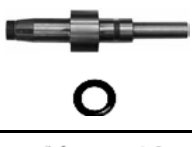
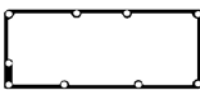















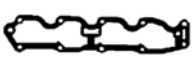





00: Gasket Set Without oil seals Without Valve Stem Seal

01: Motor Takım Keçesiz - Subap Lastikli

01: Gasket set With Valve Stem Seal Without Oil Seals

02: Motor Full Takım Keçeli ve Subap Lastikli

02: Gasket Full Set With oil seals and Valve Stem Seals

Subap Kapak Valve Cover Gasket Zylinderkopfhaube Couvre-culbut.	Karter Oil Pan Ölwanne Carter d'huile	Emme Manifold Intake Manifold Ansaug Admission	Egzoz Manifold Exhaust Manifold Auspuffkrümmer Collecteur D'échappement	Eksoz Boğaz Exhaust Pipe Auspuff Kehle	Supap Keçesi Valve Stem Seal Ventilschaft Queue de soupape	
						
 <b>61233025</b> 0249.71	 <b>61203013</b> 0304.34 93502226.	 <b>61233018x4</b> 0348.E6 + 0348F6	 <b>61233020x4</b> 1723.63		 <b>60107027x8</b> 0956.22 <b>8x10,8/14,2x10</b>	<b>21201062</b> 36x50x7 RD
 <b>61210525</b> 0249.14	 <b>61210013</b> 0304.44	 <b>61211016</b> 0348.33	 <b>61210020</b> 0349.03		 <b>60107027x8</b> 0956.22 <b>8x10,8/14,2x10</b>	
 <b>60308035x2</b> 4388512	 <b>60303013</b> 4331606	 <b>60308018</b> 4194060	 <b>60308020</b> 4177112 7709259	 <b>60308017</b> 4166914	 <b>60107027x8</b> 7553637 <b>8x10,8/14,2x10</b>	<b>21201006x2</b> 30x52x7 RD
 <b>60308034x2</b> 4158646						<b>21201017</b> 40x56x7 RD
 <b>61203525</b> 9350144480 0249.91	 <b>61203013</b> 96042653	 <b>61203116x2</b> 0348.99	 <b>61205019</b> 1721.01 7810024000		 <b>60107027x8</b> 7553637 <b>8x10,8/14,2x10</b>	<b>21201011x2</b> 35x50x8 WD
	 <b>61203014</b> 93501565	 <b>61203018x2</b> 91508659	 <b>61203120x2</b> 0349.47 93010402			<b>21201019</b> 42x62x8 RD
		 <b>61203021</b> 961004880				<b>21201040</b> 90x110x7 LD

■ : Delik - Çentik

■ : Hole - Notch

■ : Trou - Entaille

NOT: Katalogdaki Orijinal Kodlar Referans Amacıyla Kullanılmıştır.Lütfen COTECH Kodlarını Kullanınız.  
Original codes used for reference only.Please use COTECH codes for orders.

00



01



02



03



04



Silindir Kapak  
Cylinder Head  
Zylinderkopf  
Joint de culasse



Ltr	MODEL	PS/KW	ENGINE/MOTOR		
1,9 1910	<b>4 CYL ø82</b> BRAVA JTD 09/96--> BRAVO JTD DOBLO JTD MAREA TD PALIO PUNTO JTD STRADA JTD BRAVO 01/01--> DOBLO DOBLO D DOBLO JTD IDEA JTD MAREA JTD MULTIPLA MULTIPLA JTD PUNTO JTD STILO STILO D STILO JTD PUNTO JTD 02/00--> DOBLO JTD 10/01-->	100 PS / 74 KW 80 PS / 59 KW  120 PS / 88 KW 80 PS / 59 KW  86 PS / 63 KW 105 PS / 77 KW 100 PS / 74 KW	182 B9.000 188 A2.000  186 A6.000 186 A8.000 186 A9.000 188 B2.000 192 A1.000 192 A3.000 192 A8.000 192 A9.000 192 B5.000 223 A7.000 937 A7.000 188 A7.000 223 B1.000 223 B2.000	62427802 71718123 71716050  62427803 71716051  62427704 71730213	 <b>62427805</b> 46749904 0,82mm ø83 <b>62427806</b> 46749905 0,92mm 1 <b>M</b> ø83 <b>62427807</b> 46749906 1,02mm 2 <b>M</b> MLS ø83
1,9 1929	<b>4 CYL ø82,6</b> REGATA 04/84-->07/89 REGATA 04/84-->07/89 DUCATO 01/88-->08/90 MARENGO 1987-->1989 TALENTO 03/89-->03/94 TEMPRA 1990--> DUNA UNO Diesel Furgoneta S/SX/ELX Turbo Diesel	65 PS / 48 KW 65 PS / 48 KW 71 PS / 52 KW 70 PS / 51 KW 71 PS / 52 KW	149 A1.000 M705BA.19.0 149 B1.000 149 B1.000 149 B1.000 149 A1.000	62423502 5882358   62423602 5882358+5962713	 <b>62423505</b> 5962713 1,95mm 2 <b>M</b> <b>62423506</b> 5962712 1,80mm 1 <b>M</b> <b>62423507</b> 5962711 1,65mm ø83
1,9 1929	<b>4 CYL ø82,6</b> REGATA TD 06/86-->07/89 REGATA TD 1986-->1990 RITMO TD STRADA TD	80 PS / 59 KW 80 PS / 59 KW	831 D1.000 M707AT.19.0		 <b>62423505</b> 5962713 1,95mm 2 <b>M</b> <b>62423506</b> 5962712 1,80mm 1 <b>M</b> <b>62423507</b> 5962711 1,65mm ø83

▲ : İçerikte Bulunmamaktadır...

▲ : Not included in the set

▲ : Non inclus dans la pochette

00: Motor Takım Keçesiz ve Subap Lastiksiz











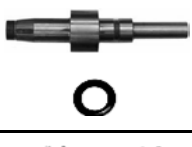
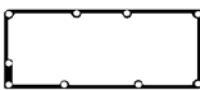

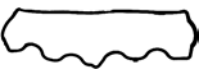

00: Gasket Set Without oil seals Without Valve Stem Seal

01: Motor Takım Keçesiz - Subap Lastikli

01: Gasket set With Valve Stem Seal Without Oil Seals

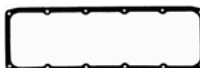
02: Motor Full Takım Keçeli ve Subap Lastikli

02: Gasket Full Set With oil seals and Valve Stem Seals

Subap Kapak Valve Cover Gasket Zylinderkopfhaube Couvre-culbut.	Karter Oil Pan Ölwanne Carter d'huile	Emme Manifold Intake Manifold Ansaug Admission	Egzoz Manifold Exhaust Manifold Auspuffkrümmer Collecteur D'echappement	Eksoz Boğaz Exhaust Pipe Auspuff Kehle	Supap Keçesi Valve Stem Seal Ventilschaft Queue de soupape	
						
 <b>62427825</b> 55197598		 <b>62427820</b> 71738458	 <b>62427821</b> 46467747		 <b>60107027x8</b> 60504110 <b>8x10,8/14,2x10</b>	<b>21208003</b> 30x42x7 RD
						<b>21201100</b> 31x41x7 RD
 <b>63111035</b> 4394109 7702774	 <b>62423513</b> 7647596 7647596	 <b>62423520</b> 4436580 7765454			 <b>60107027x8</b> 7553637 <b>8x10,8/14,2x10</b>	<b>21201006</b> 30x52x7 RD
						<b>21208056</b> 30x43x8 RD
						<b>21201066</b> 70x90x10 LD

■ : Delik - Çentik

■ : Hole - Notch

■ : Trou - Entaille

NOT: Katalogdaki Orjinal Kodlar Referans Amacıyla Kullanılmıştır.Lütfen COTECH Kodlarını Kullanınız.  
Original codes used for reference only.Please use COTECH codes for orders.

FIAT

00



01



02



03



04



Silindir Kapak  
Cylinder Head  
Zylinderkopf  
Joint de culasse

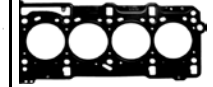

Ltr	MODEL	PS/KW	ENGINE/MOTOR		
1,9 1868	4 CYL ø82,2 SCUDO 04/98-->	69 PS / 51 KW	WJY (DW8B) WJY (DW8)	62173002 0197.X6	<p><b>62173005</b> 0209.1C 1,47mm</p> <p><b>62173006</b> 0209.X4 1,42mm 5</p> <p><b>62173007</b> 0209.X3 1,38mm 4</p> <p><b>62173008</b> 0209.X2 1,34mm 3</p> <p><b>62173009</b> 0209.X1 1,30mm 2</p> <p><b>62173010</b> 0209.X0 1,26mm 1</p> <p>MLS ø84</p>
1,9 1910	4 CYL ø82 DOBLO D 09/99--> PALIO PALIO D PUNTO D PUNTO DS  SIENA STRADA D	63 PS / 46 KW 60 PS / 45 KW	188 A3.000 223 A6.000	62427702 71715698	<p><b>62427705</b> 46529117 0,82mm</p> <p><b>62427706</b> 46529118 0,92mm 1</p> <p><b>62427707</b> 46529119 1,02mm 2</p> <p>MLS ø83</p>
				62427703 71715699	
				62427704 71730213	

▲ : İçerikte Bulunmamaktadır...

▲ : Not included in the set

▲ : Non inclus dans la pochette

00: Motor Takım Keçesiz ve Subap Lastiksiz











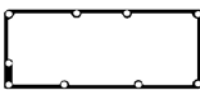





00: Gasket Set Without oil seals Without Valve Stem Seal

01: Motor Takım Keçesiz - Subap Lastikli

01: Gasket set With Valve Stem Seal Without Oil Seals

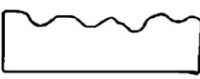
02: Motor Full Takım Keçeli ve Subap Lastikli

02: Gasket Full Set With oil seals and Valve Stem Seals

Subap Kapak Valve Cover Gasket Zylinderkopfhaube Couvre-culbut.	Karter Oil Pan Ölwanne Carter d'huile	Emme Manifold Intake Manifold Ansaug Admission	Egzoz Manifold Exhaust Manifold Auspuffkrümmer Collecteur D'echappement	Eksoz Boğaz Exhaust Pipe Auspuff Kehle	Supap Keçesi Valve Stem Seal Ventilschaft Queue de soupape	
						
						<b>21208023</b> 35x50x8 RD
<b>62173025</b> 0249.95	<b>61203013</b> 96042653	<b>62173018x2</b> 0348.N2	<b>62173021x2</b> 0349.H7		<b>60107027x8</b> 7553637 8x10,8/14,2x10	<b>21201019</b> 42x62x8 RD
		 46548450x4	 <b>62427721</b> 46467747		 <b>60107027x8</b> 7553637 8x10,8/14,2x10	<b>21201005</b> 30x42x7 RD
<b>62427725</b> 46552748		 46548459x4 <b>62427719x8</b>				<b>21201100</b> 31x41x7 RD

■ : Delik - Çentik

■ : Hole - Notch

■ : Trou - Entaille

NOT: Katalogdaki Orjinal Kodlar Referans Amacıyla Kullanılmıştır.Lütfen COTECH Kodlarını Kullanınız.  
Original codes used for reference only.Please use COTECH codes for orders.

00



Silindir Kapak  
Cylinder Head  
Zylinderkopf  
Joint de culasse

01



02



03



04

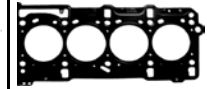

Ltr	MODEL	PS/KW	ENGINE/MOTOR			
1,9 1929	<b>4 CYL ø82,6</b> BRAVA 10/95-->10/01 BRAVO 10/95-->10/01 DUCATO TD 06/90-->04/95 DUCATO TD 03/89-->03/94 TEMPRA TD 05/1990-->08/1996 TEMPRA TD 07/91-->08/96 TIPO TD 09/90-->04/95 DUCATO TD 04/93-->	65 PS / 48 KW 65 PS / 48 KW 90 PS / 66 KW 82 PS / 60 KW 90 PS / 66 KW 65 PS / 48 KW 90 PS / 66 KW 82 PS / 60 KW	160 A7.000 160 A7.000 280 A1.000 280 A1.000 160 A6.000 160 A7.000 160 D1.000 160 A6.000 160 A7.000 160 B.0646 160 A.0646 230 A3.000 230 A4.000			 <b>62426605</b> 46431642 1,95mm 2 <b>▲</b> <b>62426606</b> 46431640 1,80mm 1 <b>▲</b> <b>62426607</b> 7630180 1,65mm FIBER / FIBRE <b>ø83,5</b>
2,0 1971	<b>4 CYL ø88</b> DUCATO 1981--> TALENTO 10/81-->02/89	75 PS / 55 KW 75 PS / 55 KW	280/B25/170B 170 C 170 D XM1T 170 B	<b>61211001</b> 9400197139	 <b>61211005</b> 0209.46 1,20mm <b>61211006</b> 0209.46 1,80mm <b>ø90</b>	
2,0 1995	<b>4 CYL ø84</b> 131 06/78-->01/82 131 06/78-->01/82 132 07/77-->06/81 ARGENTA 05/78-->07/82	115 PS / 85 KW 115 PS / 85 KW 112 PS / 82 KW 113 PS / 83 KW	131 B2.000 131 B2.000(TC) 132 C2.000 2000	<b>60309002</b> 5880452  <b>60309000</b> 5880452	 <b>60309005</b> 4387624 1,40mm <b>60309006</b> 5951675 1,80mm <b>ø85</b>	
2,0 1995	<b>4 CYL ø84</b> TIPO 06/90-->03/92 TEMPRA 10/90-->08/96 CROMA 03/87-->09/92	109 PS / 80 KW 113 PS / 83 KW 120 PS / 8 KW	159 A5.046 159 A6.046 154 C3.000	<b>62424001</b> 5893330	 <b>62424005</b> 7660966 1,80mm <b>ø85</b>	

▲ : İçerikte Bulunmamaktadır...

▲ : Not included in the set

▲ : Non inclus dans la pochette

00: Motor Takım Keçesiz ve Subap Lastiksiz











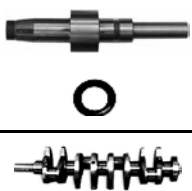
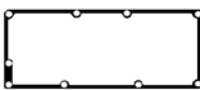





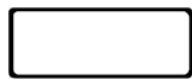







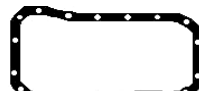

00: Gasket Set Without oil seals Without Valve Stem Seal

01: Motor Takım Keçesiz - Subap Lastikli

01: Gasket set With Valve Stem Seal Without Oil Seals

02: Motor Full Takım Keçeli ve Subap Lastikli

02: Gasket Full Set With oil seals and Valve Stem Seals

Subap Kapak Valve Cover Gasket Zylinderkopfhaube Couvre-culbut.	Karter Oil Pan Ölwanne Carter d'huile	Emme Manifold Intake Manifold Ansaug Admission	Egzoz Manifold Exhaust Manifold Auspuffkrümmer Collecteur D'echappement	Eksoz Boğaz Exhaust Pipe Auspuff Kehle	Supap Keçesi Valve Stem Seal Ventilschaft Queue de soupape	
						
 <b>61210525</b> 7910009723	 <b>61210013</b> 0322.10 0304.11	 <b>61211016</b> 7910018516  <b>61211015</b> 0348.21	 <b>61210020</b> 7910009720  <b>61205017</b> 1710.09  <b>61212019</b> 1710.19		 <b>60107027x8</b> 7553637 8x10,8/14,2x10	
 <b>60308035x2</b> 4388512  <b>60308034x2</b> 4158646	 <b>60303013</b> 4331606	 <b>60308018</b> 4194060	 <b>60308020</b> 4177112 7709259	 <b>60308017</b> 4166914	 <b>60107027x8</b> 7553637 8x10,8/14,2x10	<b>21201006x2</b> 30x52x7 RD <b>21201017</b> 40x56x7 RD <b>21201066</b> 70x90x10 LD
 <b>60330034x2</b> 7660565  <b>60331035x2</b> 7684064	 <b>62424013</b> 7646248	 <b>60330019</b> 7700197	 <b>60308020</b> 4368925		 <b>60107027x8</b> 7553637 8x10,8/14,2x10	

■ : Delik - Çentik

■ : Hole - Notch

■ : Trou - Entaille

NOT: Katalogdaki Orijinal Kodlar Referans Amacıyla Kullanılmıştır.Lütfen COTECH Kodlarını Kullanınız.  
Original codes used for reference only.Please use COTECH codes for orders.

00



Silindir Kapak

Cylinder Head

01



Zylinderkopf

02







Joint de culasse

03

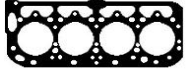

04



Ltr	MODEL	PS/KW	ENGINE/MOTOR		
2,5 2500	4 CYL ø93 DUCATO 01/82-->12/86	75 PS / 55 KW	U25/651	61215003 0197.K1	 <b>61215005</b> 0209.L5 1,40mm ø95,5
2,5 2500	4 CYL ø93 DUCATO 09/86-->05/94 DUCATO TD 03/94--> DUCATO DUCATO TDI	95 PS / 70 KW 116 PS / 85 KW 109 PS / 80 KW	8140.27 8140.47 8140.47R 8140.47R.2210 8140.47.3700 8142.27S/28		 <b>60138005</b> 98448817 1,50mm <b>60138006</b> 99461499 1,40mm ø95
2,5 2500	4 CYL ø93 DUCATO D 03/94-->04/02 CROMA D 01/82-->03/94 DUCATO D	84 PS / 62 KW 75 PS / 55 KW	8140.67 8144.67 8144.67.220		 <b>60147005</b> 98498291 1,80mm <b>60147006</b> 98492581 1,70mm ø95,2
2,8 2799	4 CYL ø94,4 DUCATO 01/96--> DUCATO TDI	122 PS / 90 KW	8140.23 8140.43	60139000 99477116	 <b>60139005</b> 99458402 1,50mm <b>60139006</b> 99460983 1,40mm <b>60139007</b> 99432353 1,30mm ø96

▲ : İçerikte Bulunmamaktadır...

▲ : Not included in the set

▲ : Non inclus dans la pochette

00: Motor Takım Keçesiz ve Subap Lastiksiz











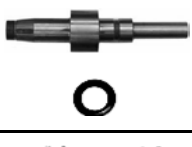
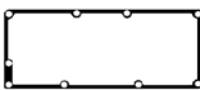





00: Gasket Set Without oil seals Without Valve Stem Seal

01: Motor Takım Keçesiz - Subap Lastikli

01: Gasket set With Valve Stem Seal Without Oil Seals

02: Motor Full Takım Keçeli ve Subap Lastikli

02: Gasket Full Set With oil seals and Valve Stem Seals

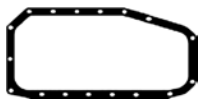
Subap Kapak Valve Cover Gasket Zylinderkopfhaube Couvre-culbut.	Karter Oil Pan Ölwanne Carter d'huile	Emme Manifold Intake Manifold Ansaug Admission	Egzoz Manifold Exhaust Manifold Auspuffkrümmer Collecteur D'echappement	Eksoz Boğaz Exhaust Pipe Auspuff Kehle	Supap Keçesi Valve Stem Seal Ventilschaft Queue de soupape	
						
 <b>61215025</b> 5893816		 <b>61215019x4</b> 5414228	 <b>61215021x4</b> 5452930	 <b>61215017</b> 95494600		
 <b>60138045</b> 500388382	 <b>60146066</b> 7301683	 <b>60146019x4</b> 98425767	 <b>60147021x4</b> 98434020			
 <b>60138047</b> 0249.C3	 <b>60138068</b> 500327440					

■ : Delik - Çentik

■ : Hole - Notch

■ : Trou - Entaille

NOT: Katalogdaki Orjinal Kodlar Referans Amacıyla Kullanılmıştır.Lütfen COTECH Kodlarını Kullanınız.  
Original codes used for reference only.Please use COTECH codes for orders.

FIAT

00



Silindir Kapak  
Cylinder Head

01



Zylinderkopf

02





Joint de culasse

03



04



Ltr	MODEL	PS/KW	ENGINE/MOTOR		
2,8 2799	4 CYL ø94,4 DUCATO DUCATO JTD 11/00-->	128 PS / 94 KW 126 PS / 93 KW	8140.43S	60139100 71713696 	 <b>60139005</b> 99458402 1,50mm <b>60139006</b> 99460983 1,40mm <b>60139007</b> 99432353 1,30mm ø96
2,8 2799	4 CYL ø94,4 DUCATO DUCATO D 02/98-->04/02	87 PS / 64 KW	8140.63		 <b>60147105</b> 500306172 1,80mm <b>60147106</b> 500306171 1,70mm <b>60147107</b> 500306170 1,60mm ø96

▲ : İçerikte Bulunmamaktadır...

▲ : Not included in the set

▲ : Non inclus dans la pochette

00: Motor Takım Keçesiz ve Subap Lastiksiz











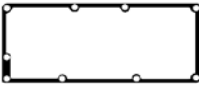

00: Gasket Set Without oil seals Without Valve Stem Seal

01: Motor Takım Keçesiz - Subap Lastikli

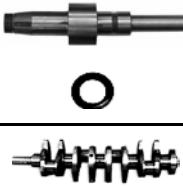
01: Gasket set With Valve Stem Seal Without Oil Seals

02: Motor Full Takım Keçeli ve Subap Lastikli

02: Gasket Full Set With oil seals and Valve Stem Seals

<p>Subap Kapak Valve Cover Gasket Zylinderkopfhaube Couvre-culbut.</p> 	<p>Karter Oil Pan Ölwanne Carter d'huile</p> 	<p>Emme Manifold Intake Manifold Ansaug Admission</p> 	<p>Egzoz Manifold Exhaust Manifold Auspuffkrümmer Collecteur D'echappement</p> 	<p>Eksoz Boğaz Exhaust Pipe Auspuff Kehle</p> 	<p>Supap Keçesi Valve Stem Seal Ventilschaft Queue de soupape</p> 	
 <p><b>60138045</b> 500388382</p>  <p><b>60138047</b> 500388381</p>	 <p><b>60138068</b> 98446492</p>	 <p><b>60146019x4</b> 98425767</p>	 <p><b>60147021x4</b> 98434020</p>			

■ : Delik - Çentik

■ : Hole - Notch

■ : Trou - Entaille

NOT: Katalogdaki Orijinal Kodlar Referans Amacıyla Kullanılmıştır.Lütfen COTECH Kodlarını Kullanınız.  
Original codes used for reference only.Please use COTECH codes for orders.

FORD

00



Silindir Kapak

Cylinder Head

01



Zylinderkopf

02











Joint de culasse

03



04



Ltr	MODEL	PS/KW	ENGINE/MOTOR		
1,3 1248	4 CYL ø69,6 KA TDCI 16V (DOCH) 10/08-->	75 PS / 55 KW	13DDOX FD4	<p><b>62427402</b> Motor Full Takım Gasket Full Set</p>   <p><b>62427403</b> 1 564 796</p>  <p><b>62427404</b> 1 564 795</p> 	 <p><b>62427505</b> 1 538 719 <b>0,72mm</b></p> <p><b>62427506</b> 1 538 721 0,82mm 1 </p> <p><b>62427507</b> 1 538 722 0,92mm 2 </p> <p><b>MLS</b> <b>ø70,5</b></p>
1,3 1323	4 CYL ø71 FESTIVA (SOCH) 1988-->1993	69 / PS / 51 KW	B3		 <p><b>61410605</b> B302-10-271 1,60mm</p> <p><b>61410606</b> B302-10-271 2,00mm</p> <p><b>ø74</b></p>

▲ : İçerikte Bulunmamaktadır...

▲ : Not included in the set

▲ : Non inclus dans la pochette

00: Motor Takım Keçesiz ve Subap Lastiksiz







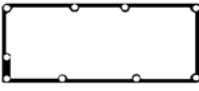

00: Gasket Set Without oil seals Without Valve Stem Seal

01: Motor Takım Keçesiz - Subap Lastikli

01: Gasket set With Valve Stem Seal Without Oil Seals

02: Motor Full Takım Keçeli ve Subap Lastikli

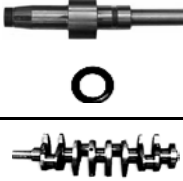
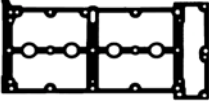
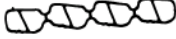
02: Gasket Full Set With oil seals and Valve Stem Seals

<p>Subap Kapak Valve Cover Gasket Zylinderkopfhaube Couvre-culbut.</p> 	<p>Karter Oil Pan Ölwanne Carter d'huile</p> 	<p>Emme Manifold Intake Manifold Ansaug Admission</p> 	<p>Egzoz Manifold Exhaust Manifold Auspuffkrümmer Collecteur D'echappement</p> 	<p>Eksoz Boğaz Exhaust Pipe Auspuff Kehle</p> 	<p>Supap Keçesi Valve Stem Seal Ventilschaft Queue de soupape</p> 	
 <p><b>62427425</b> 1 563 470</p>		 <p><b>62427417</b> 1 539 476</p>	 <p><b>62427421</b> 1 538 710</p>		 <p><b>62427426x16</b> 1 547 971 6x8,8x11,7x9,5</p>	<p><b>21204023</b> 40x52x7 RD</p> <p><b>21204034</b> 78X100X9 RD</p>

■ : Delik - Çentik

■ : Hole - Notch





■ : Trou - Entaille

NOT: Katalogdaki Orijinal Kodlar Referans Amacıyla Kullanılmıştır.Lütfen COTECH Kodlarını Kullanınız.  
Original codes used for reference only.Please use COTECH codes for orders.

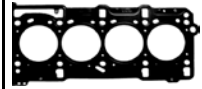

Silindir Kapak  
Cylinder Head  
Zylinderkopf  
Joint de culasse



Ltr	MODEL	PS/KW	ENGINE/MOTOR		
1,4 1398	4 CYL ø73,7 FIESTA TDCI 11/01--> FUSION TDCI	70 PS / 51 KW 68 PS / 50 KW	F6JA F6JB F6JD DURATORQ (14DS4X)	<p><b>61706002</b> Motor Full Takım Gasket Full Set</p>  <p><b>61706003</b> Motor Üst Takım Gasket Head Set</p>  <p><b>61706004</b> Motor Alt Takım Conversion Set</p>	<p><b>61706008</b> 1 146 049 1,25mm 2 ▲</p> <p><b>61706007</b> 1 146 050 1,30mm 3 ▲</p> <p><b>61706009</b> 1 146 051 1,35mm 1 ▲</p> <p><b>61706006</b> 1 146 052 1,40mm 4 ▲</p> <p><b>61706005</b> 1 146 053 1,45mm 5 ▲ MLS ø75</p>
1,6 1560	4 CYL ø75 C-MAX TDCI 10/03--> FIESTA TDCI FOCUS TDCI FUSION TDCI ( DOCH 16 V )	109 PS / 80 KW 75 PS / 55 KW	G8DA G8DB G8DC G8DD G8DE G8DF HHDA HHDB HHJA HHJB HHJC HHJD HHJE HHJF MTDA UBJA DURATORQ(16DDOX)	<p><b>61707002</b> Motor Full Takım Gasket Full Set</p>  <p><b>61707003</b> Motor Üst Takım Gasket Head Set</p>  <p><b>61707004</b> Motor Alt Takım Conversion Set</p>	<p><b>61707008</b> 1 229 877 1,25mm 2 ▲</p> <p><b>61707007</b> 1 229 878 1,30mm 3 ▲</p> <p><b>61707005</b> 1 229 879 1,35mm 1 ▲</p> <p><b>61707006</b> 1 229 880 1,40mm 4 ▲</p> <p><b>61707005</b> 1 229 881 1,45mm 5 ▲ MLS ø76</p>

▲ : İçerikte Bulunmamaktadır...

▲ : Not included in the set

▲ : Non inclus dans la pochette

00: Motor Takım Keçesiz ve Subap Lastiksiz











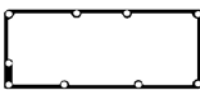



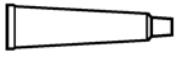

00: Gasket Set Without oil seals Without Valve Stem Seal

01: Motor Takım Keçesiz - Subap Lastikli

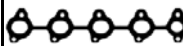
01: Gasket set With Valve Stem Seal Without Oil Seals

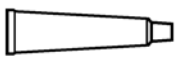
02: Motor Full Takım Keçeli ve Subap Lastikli

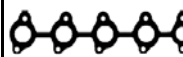
02: Gasket Full Set With oil seals and Valve Stem Seals

Subap Kapak Valve Cover Gasket Zylinderkopfhaube Couvre-culbut.	Karter Oil Pan Ölwanne Carter d'huile	Emme Manifold Intake Manifold Ansaug Admission	Egzoz Manifold Exhaust Manifold Auspuffkrümmer Collecteur D'echappement	Eksoz Boğaz Exhaust Pipe Auspuff Kehle	Supap Keçesi Valve Stem Seal Ventilschaft Queue de soupape	
						
						<b>2120417</b> 27x47x7 RD
<b>61706025</b> 1 148 101	<b>62427465</b>	<b>61706019x4</b> 1 148 106	<b>61706021</b> 1 148 115		<b>61706027x8</b> 5,5x9,5x22,9x17,5	<b>21204018</b> 40x55x6,4 RD
		 				<b>2120417</b> 27x47x7 RD
<b>61707025</b> 1 235 994	<b>62427465</b>	<b>1 254 376x4</b>  <b>1 254 375x4</b>  <b>61707018x8</b> SET	<b>61706021</b> 1 148 115		<b>61707026x16</b> 5,5x9,5x18,1x14	<b>21204018</b> 40x55x6,4 RD
						<b>21204019</b> 85x105x8,8 LD

■ : Delik - Çentik

■ : Hole - Notch

■ : Trou - Entaille

NOT: Katalogdaki Orjinal Kodlar Referans Amacıyla Kullanılmıştır.Lütfen COTECH Kodlarını Kullanınız.  
Original codes used for reference only.Please use COTECH codes for orders.

00



Silindir Kapak  
Cylinder Head

01



Zylinderkopf

02



Joint de culasse

03



04



Ltr	MODEL	PS/KW	ENGINE/MOTOR		
1,6 1596	4 CYL ø79 C-MAX 16 V FOCUS 16 V FIESTA 16 V FUSION 16 V ( DOCH )	10/03-->	100 PS / 74 KW HWDA ZETEC-S(16HDEZ) FYJA		 <b>62218205</b> 1 305 949 1,20mm FIBER / FIBRE ø80
1,6 1597	4 CYL ø82,7 KA STREET	05/03-->11/08	95 PS / 70 KW CDB CDC CDRA CDRB		 <b>61218105</b> 1 099 084 1,20mm FIBER / FIBRE ø83
1,8 1781	4 CYL ø81 BELINA DEL REY ESCORT PAMPA SCALA VERONA ROYALE VERSAILLES ( BRASIL )	1989-->1996	85 PS / 62 KW AP	<b>61408002</b> Motor Full Takım Gasket Full Set  <b>61408003</b> 027 198 012 L  <b>61402004</b> 037 198 011 C	 <b>61408005</b> 026 103 383K 1,75mm ø83
1,8 1796	4 CYL ø78 COURIER	1972-->1980	VB	<b>61420002</b> 8051-99-100	 <b>61420005</b> R201-10-271F 1,50mm  <b>61420006</b> R201-10-271F 2,00mm  ø80

▲ : İçerikte Bulunmamaktadır...

▲ : Not included in the set

▲ : Non inclus dans la pochette

00: Motor Takım Keçesiz ve Subap Lastiksiz











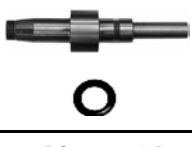
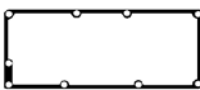







00: Gasket Set Without oil seals Without Valve Stem Seal

01: Motor Takım Keçesiz - Subap Lastikli

01: Gasket set With Valve Stem Seal Without Oil Seals

02: Motor Full Takım Keçeli ve Subap Lastikli

02: Gasket Full Set With oil seals and Valve Stem Seals

Subap Kapak Valve Cover Gasket Zylinderkopfhaube Couvre-culbut.	Karter Oil Pan Ölwanne Carter d'huile	Emme Manifold Intake Manifold Ansaug Admission	Egzoz Manifold Exhaust Manifold Auspuffkrümmer Collecteur D'echappement	Eksoz Boğaz Exhaust Pipe Auspuff Kehle	Supap Keçesi Valve Stem Seal Ventilschaft Queue de soupape	
						
						<b>21201075x3</b> 32x47x10 WD
<b>61401034</b> 026 198 025 A	<b>61401013</b> 028 103 609 A	<b>61401019</b> 026129717D	<b>61401021x4</b> 026 129 589 A	<b>61401017</b> 841 253 115 B	<b>60107027x8</b> 8x10,8x14,2x10	<b>21204504</b> 85X105X12 LD
						<b>21201026</b> 48x70x12 RD
<b>61420034</b> 022110235A	<b>61420013</b> 0221-10-431	<b>61420019</b> 038113111A	<b>61420020</b> 0221-13-462	<b>61420017</b> 802B-13-483		<b>21201205</b> 80x105x13 LD

■ : Delik - Çentik

■ : Hole - Notch

■ : Trou - Entaille

NOT: Katalogdaki Orijinal Kodlar Referans Amacıyla Kullanılmıştır.Lütfen COTECH Kodlarını Kullanınız.  
Original codes used for reference only.Please use COTECH codes for orders.

FORD

00



01



02



03







04



Silindir Kapak  
Cylinder Head  
Zylinderkopf  
Joint de culasse



Ltr	MODEL	PS/KW	ENGINE/MOTOR		
1,9 1896	4 CYL ø79,5 GALAXY TDI 03/95-->05/06	90 PS / 66 KW	1Z AFN AHU	<p><b>61405202</b> Motor Full Takım Gasket Full Set</p>   <p><b>61405203</b> 1 009 167</p>  <p><b>61405104</b> 1 004 926</p> 	<p><b>61405207</b> 1 079 766 1 005 254 1,45mm 1 ■</p> <p><b>61405206</b> 1 079 767 1 005 258 1,53mm 2 ■</p> <p><b>61405205</b> 1 079 768 1 005 261 1,61mm 3 ■</p> <p><b>MLS</b> ø81</p>
2,0 1984	4 CYL ø82,5 VERSAILLES ROYALE ESCORT VERONA ( BRASIL ) 1992-->1995		AP	<p><b>61408102</b></p>	<p><b>61408105</b> 048 103 383B 1,75mm ø83,5</p>
2,0 1999	4 CYL ø87,5 C-MAX 16 V FIESTA 16 V FOCUS 16 V GALAXY 16 V MONDEO 16 V S-MAX 16 V FUSION 16 V 03/04-->	150 PS / 110 KW 145 PS / 107 KW	AOBA AOBC AODA AODB AODE AOWA AOWB N4JB SYDA TBBA TBBB TBWA TBWB CJBA DURATEC-HE(20HDEA)		<p><b>61420405</b> 1 229 872 1,20mm FIBER / FIBRE ø89</p>

▲ : İçerikte Bulunmamaktadır...

▲ : Not included in the set

▲ : Non inclus dans la pochette

00: Motor Takım Keçesiz ve Subap Lastiksiz











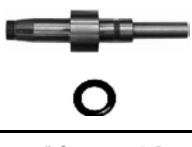
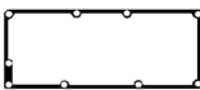





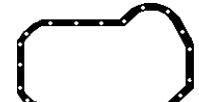

00: Gasket Set Without oil seals Without Valve Stem Seal

01: Motor Takım Keçesiz - Subap Lastikli

01: Gasket set With Valve Stem Seal Without Oil Seals

02: Motor Full Takım Keçeli ve Subap Lastikli

02: Gasket Full Set With oil seals and Valve Stem Seals

Subap Kapak Valve Cover Gasket Zylinderkopfhaube Couvre-culbut.	Karter Oil Pan Ölwanne Carter d'huile	Emme Manifold Intake Manifold Ansaug Admission	Egzoz Manifold Exhaust Manifold Auspuffkrümmer Collecteur D'echappement	Eksoz Boğaz Exhaust Pipe Auspuff Kehle	Supap Keçesi Valve Stem Seal Ventilschaft Queue de soupape	
						
 <b>61405225</b> 028 103 483 C 028 103 483 G	 <b>61401014</b> 1 033 121	 <b>61405121</b> 1 006 217	 <b>61401021x4</b> 026 129 589 A 028 129 589 B		 <b>60107027x8</b> 1 669 785 8x10,8/14,2x10	<b>21201075x3</b> 32x47x10 WD  <b>21204504</b> 85x105x12 LD
 <b>61401034</b> 026 198 025 A	 <b>61401013</b> 028 103 609 A	 <b>61401019</b> 026 129 717 D	 <b>61401021x4</b> 026 129 589 A 056 129 589 B	 <b>61408017</b> 841 253 115 B	 <b>60107027x8</b> 026 109 675 8x10,8/14,2x10	<b>21201075x3</b> 32x47x10 W  <b>21204504</b> 85x105x12 LD

■ : Delik - Çentik

■ : Hole - Notch

■ : Trou - Entaille

NOT: Katalogdaki Orjinal Kodlar Referans Amacıyla Kullanılmıştır.Lütfen COTECH Kodlarını Kullanınız.  
Original codes used for reference only.Please use COTECH codes for orders.

00



Silindir Kapak

Cylinder Head

01



Zylinderkopf

02



Joint de culasse

03



04

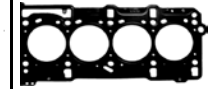

Ltr	MODEL	PS/KW	ENGINE/MOTOR		
2,1 2112	4 CYL ø90 GRANADA 08/77-->08/82 DIESEL	63PS / 47KW	GD21	61212002 0198.40	<p><b>61212005</b> 1 576 302 1,60mm</p> <p><b>61212006</b> 1 576 302 1,80mm</p> <p><b>ø94</b></p>
2,2 2184	4 CYL ø86 PROBE 12 V 08/88-->07/93 PROBE TURBO 12 V RANGER 12 V 03/99-->07/03	112 PS / 82 KW 147 PS / 108 KW	F2		<p><b>61420305</b> F202-10-271 1,40mm</p> <p><b>61420306</b> F202-10-271 1,80mm</p> <p><b>ø87,5</b></p>
2,2 2209	4 CYL ø92 RANGER 2WD	63 PS / 46 KW	S2		<p><b>41480005</b> 0527-10-271A <b>Ø 97</b></p>
2,3 2261	4 CYL ø87,5 MAVERICK 16V (DOCH) TRANSIT 03/04--> 04/06-->	150 PS / 110 KW 145 PS / 107 KW	GZ GZFA GZFC		<p><b>61420405</b> 1 229 872 1,20mm FIBER / FIBRE</p> <p><b>ø89</b></p>

▲ : İçerikte Bulunmamaktadır...

▲ : Not included in the set

▲ : Non inclus dans la pochette

00: Motor Takım Keçesiz ve Subap Lastiksiz











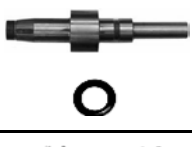
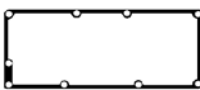

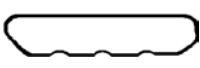

00: Gasket Set Without oil seals Without Valve Stem Seal

01: Motor Takım Keçesiz - Subap Lastikli

01: Gasket set With Valve Stem Seal Without Oil Seals

02: Motor Full Takım Keçeli ve Subap Lastikli

02: Gasket Full Set With oil seals and Valve Stem Seals

Subap Kapak Valve Cover Gasket Zylinderkopfhaube Couvre-culbut.	Karter Oil Pan Ölwanne Carter d'huile	Emme Manifold Intake Manifold Ansaug Admission	Egzoz Manifold Exhaust Manifold Auspuffkrümmer Collecteur D'echappement	Eksoz Boğaz Exhaust Pipe Auspuff Kehle	Supap Keçesi Valve Stem Seal Ventilschaft Queue de soupape	
						
 <b>61212525</b> 1 651 701	 <b>61212014</b> 0313.19  <b>61212015</b> 0304.12	 <b>61212016x3</b> 0348.11	 <b>61212020x2</b> 1 576 449	 <b>61205018</b> 1710.07  <b>61212018</b> 1710.15  <b>61212019</b> 1710.19		<b>21201020</b> 42x60x10 RD

■ : Delik - Çentik

■ : Hole - Notch

■ : Trou - Entaille

NOT: Katalogdaki Orijinal Kodlar Referans Amacıyla Kullanılmıştır.Lütfen COTECH Kodlarını Kullanınız.  
Original codes used for reference only.Please use COTECH codes for orders.

00



01



02



03















04

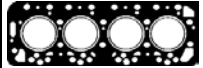

Silindir Kapak  
Cylinder Head  
Zylinderkopf  
Joint de culasse



Ltr	MODEL	PS/KW	ENGINE/MOTOR		
2,3 2304	4 CYL ø94 SIERRA D 08/82-->02/93	67 PS / 49 KW	YTR YTT(XDP2)	61218000 0198.94 	 <b>61218005</b> 6 812 074 1,73mm 4  <b>61218006</b> 6 812 073 1,63mm 3  <b>61218006</b> 6 812 072 1,53mm 2  ø96
2,3 2346	4 CYL ø91 RANGER 2WD C RANGER 4WD D BRONCO II TD 1985-->1987	82 PS / 67 KW	4D55T	61450001 MD050092  <b>61450002</b> MD050092	 <b>61450005</b> MD050545 1,80mm ø92,5
2,5 2498	4 CYL ø94 GRANADA SCORPIO SCORPIO TD GRANADA TD 08/82-->07/93	92 PS / 68 KW 69 PS / 51 KW	SFA SFB STP STR XD3	61218000 0198.94 	 <b>61218005</b> 6 812 074 1,73mm 4  <b>61218006</b> 6 812 073 1,63mm 3  <b>61218006</b> 6 812 072 1,53mm 2  ø96

▲ : İçerikte Bulunmamaktadır...

▲ : Not included in the set

▲ : Non inclus dans la pochette

00: Motor Takım Keçesiz ve Subap Lastiksiz











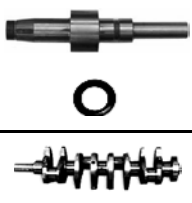
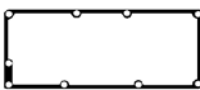







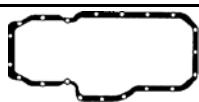



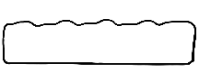

00: Gasket Set Without oil seals Without Valve Stem Seal

01: Motor Takım Keçesiz - Subap Lastikli

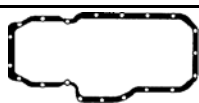
01: Gasket set With Valve Stem Seal Without Oil Seals

02: Motor Full Takım Keçeli ve Subap Lastikli

02: Gasket Full Set With oil seals and Valve Stem Seals





Subap Kapak Valve Cover Gasket Zylinderkopfhaube Couvre-culbut.	Karter Oil Pan Ölwanne Carter d'huile	Emme Manifold Intake Manifold Ansaug Admission	Egzoz Manifold Exhaust Manifold Auspuffkrümmer Collecteur D'echappement	Eksoz Boğaz Exhaust Pipe Auspuff Kehle	Supap Keçesi Valve Stem Seal Ventilschaft Queue de soupape	
						
 <b>61212525</b> 1 651 701	 <b>61212014</b> 6 894 122  <b>61212015</b> 0304.12	 <b>61212016x3</b> 0348.11	 <b>61212020x2</b> 0349.10	 <b>61212018</b> 1710.15  <b>61212019</b> 1710.19		
 <b>61450025</b> MD050312	 <b>61450013</b> MD149392	 <b>61450021</b> MD050482			 <b>61450026x8</b> 8x13x9x13	<b>21201013</b> 35x50x8 RD <b>21201023</b> 44x60x7 RD <b>21201035</b> 80x96x9 LD <b>21201004</b> 25x35x6 <b>21201001</b> 17x28x7
 <b>61212525</b> 1 651 701	 <b>61212014</b> 6 894 122  <b>61212015</b> 0304.12	 <b>61212016x3</b> 0348.11	 <b>61212020x2</b> 0349.10	 <b>61212018</b> 1710.15  <b>61212019</b> 1710.19		



■ : Delik - Çentik

■ : Hole - Notch

■ : Trou - Entaille

NOT: Katalogdaki Orjinal Kodlar Referans Amacıyla Kullanılmıştır.Lütfen COTECH Kodlarını Kullanınız.  
Original codes used for reference only.Please use COTECH codes for orders.

00		Silindir Kapak Cylinder Head
01		Zylinderkopf
02		Joint de culasse
03		
04		

Ltr	MODEL	PS/KW	ENGINE/MOTOR	
1,2 1238 1,3 1335	<b>4 CYL ø72</b> CIVIC CIVIC	03/77-->12/80 09/79-->09/83	54 PS / 40 KW 60 PS / 44 KW	EB1 EB2 EB3 EN1 EN4
				 <b>61430005</b> 12251-634-010 1,40mm ø74
1,6 1602	<b>4 CYL ø77</b> ACCORD QUINTET PRELUDE	01/78-->09/93	80 PS / 59 KW	EG EL EL14
				 <b>61440005</b> 12251-PC1-000 1,40mm ø78

▲ : İçerikte Bulunmamaktadır...

▲ : Not included in the set

▲ : Non inclus dans la pochette

00: Motor Takım Keçesiz ve Subap Lastiksiz







00: Gasket Set Without oil seals Without Valve Stem Seal

01: Motor Takım Keçesiz - Subap Lastikli

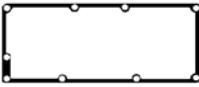
01: Gasket set With Valve Stem Seal Without Oil Seals

02: Motor Full Takım Keçeli ve Subap Lastikli

02: Gasket Full Set With oil seals and Valve Stem Seals

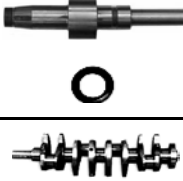
<p>Subap Kapak Valve Cover Gasket Zylinderkopfhaube Couvre-culbut.</p> 	<p>Karter Oil Pan Ölwanne Carter d'huile</p> 	<p>Emme Manifold Intake Manifold Ansaug Admission</p> 	<p>Egzoz Manifold Exhaust Manifold Auspuffkrümmer Collecteur D'echappement</p> 	<p>Eksoz Boğaz Exhaust Pipe Auspuff Kehle</p> 	<p>Supap Keçesi Valve Stem Seal Ventilschaft Queue de soupape</p> 	

■ : Delik - Çentik

■ : Hole - Notch

■ : Trou - Entaille

NOT: Katalogdaki Orijinal Kodlar Referans Amacıyla Kullanılmıştır.Lütfen COTECH Kodlarını Kullanınız.  
Original codes used for reference only.Please use COTECH codes for orders.

00  
01  
02  
03  
04



Silindir Kapak  
Cylinder Head  
Zylinderkopf  
Joint de culasse



Ltr	MODEL	PS/KW	ENGINE/MOTOR		
1,1 1086	<b>4 CYL ø67</b> ATOS PRIME 12V 06/05-->01/07 ( SOCH )	63 PS / 46 KW	G4HG		 <b>61410405</b> 22311-02760 1,20mm FIBER / FIBRE ø68
1,3 1298	<b>4 CYL ø71</b> PONY 10/89-->01/95 ( SOCH )	58 PS / 43 KW	G4M G13B G4DG		 <b>61507005</b> MD066163 1,40mm ø72,5
1,3 1341	<b>4 CYL ø71,5</b> ACCENT 12V 10/94-->01/000 GETZ 12V 09/02-->09/05 ( SOCH )	82 PS / 60 KW 84 PS / 62 KW	G4EA	<b>61500002</b> Motor Full Takım Gasket Full Set	 <b>61500005</b> 22311-22360 1,40mm FIBER / FIBRE ø73mm
1,4 1399	<b>4 CYL ø75,5</b> GETZ 16V 08/05-->11/10 ACCENT 16V VERNA 16V ( DOCH )	97 PS / 71 KW	G4EE		 <b>61410505</b> 22311-26603 1,20mm FIBER / FIBRE ø77
1,4 1396	<b>4 CYL ø77</b> ix30 16V 10/07-->11/11 ix20 16V 09/08-->	105 PS / 77 KW 109 PS / 80 KW 90 PS / 66 KW 101 PS / 74 KW	G4FA		 <b>61510106</b> 22311-2B003 1,20mm FIBER / FIBRE ø78,5

▲ : İçerikte Bulunmamaktadır...

▲ : Not included in the set

▲ : Non inclus dans la pochette

00: Motor Takım Keçesiz ve Subap Lastiksiz











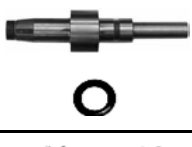
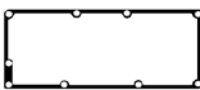



00: Gasket Set Without oil seals Without Valve Stem Seal

01: Motor Takım Keçesiz - Subap Lastikli

01: Gasket set With Valve Stem Seal Without Oil Seals

02: Motor Full Takım Keçeli ve Subap Lastikli

02: Gasket Full Set With oil seals and Valve Stem Seals

Subap Kapak Valve Cover Gasket Zylinderkopfhaube Couvre-culbut.	Karter Oil Pan Ölwanne Carter d'huile	Emme Manifold Intake Manifold Ansaug Admission	Egzoz Manifold Exhaust Manifold Auspuffkrümmer Collecteur D'echappement	Eksoz Boğaz Exhaust Pipe Auspuff Kehle	Supap Keçesi Valve Stem Seal Ventilschaft Queue de soupape	
						
 <b>61490025</b> 22441-22012	 <b>61490013</b> 21451-21010	 <b>61490018</b> 28411-26600  <b>61490016</b>	 <b>61490021</b> 28521-22020	 <b>61490017</b> 22224-22000	 <b>61490027x12</b> 22224-22000 6x11x6x10,2	<b>21201011</b> 35x50x8 RD <b>21201032</b> 72x96x9 LD

■ : Delik - Çentik

■ : Hole - Notch

■ : Trou - Entaille

NOT: Katalogdaki Orijinal Kodlar Referans Amacıyla Kullanılmıştır.Lütfen COTECH Kodlarını Kullanınız.  
Original codes used for reference only.Please use COTECH codes for orders.

00



Silindir Kapak  
Cylinder Head

01



Zylinderkopf

02



Joint de culasse

03



04



Ltr	MODEL	PS/KW	ENGINE/MOTOR		
1,5 1468	4 CYL ø75,5 EXCELL PONY LANTRA S-COUPE (SOCH) 10/85-->05/96	86 PS / 63 KW 72 PS / 53 KW	G15B G4DJ G4J		<p><b>61500305</b> MD016163 1,40mm</p> <p><b>61500306</b> MD016163 2,00mm ø76,5</p>
1,5 1495	4 CYL ø75,5 ACCENT LANTRA S COUPE (SOCH) 10/94-->01/00	88 PS / 65 KW	G4EK	<b>61490002</b> 20910-22A00	<p><b>61490005</b> 22311-22130 1,40mm FIBER / FIBRE ø77</p>
1,6 1591	4 CYL ø77 i30 i20 ix20 10/07-->11/11 09/08--> 11/10-->	116 PS / 85 KW 126 PS / 93 KW 125 PS / 92 KW	G4FC		<p><b>61510106</b> 22311-2B003 1,20mm FIBER / FIBRE ø78,5</p>

▲ : İçerikte Bulunmamaktadır...

▲ : Not included in the set

▲ : Non inclus dans la pochette

00: Motor Takım Keçesiz ve Subap Lastiksiz











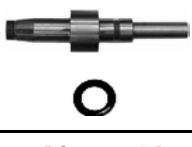
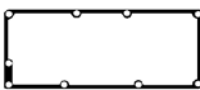



00: Gasket Set Without oil seals Without Valve Stem Seal

01: Motor Takım Keçesiz - Subap Lastikli

01: Gasket set With Valve Stem Seal Without Oil Seals

02: Motor Full Takım Keçeli ve Subap Lastikli

02: Gasket Full Set With oil seals and Valve Stem Seals

Subap Kapak Valve Cover Gasket Zylinderkopfhaube Couvre-culbut.	Karter Oil Pan Ölwanne Carter d'huile	Emme Manifold Intake Manifold Ansaug Admission	Egzoz Manifold Exhaust Manifold Auspuffkrümmer Collecteur D'echappement	Eksoz Boğaz Exhaust Pipe Auspuff Kehle	Supap Keçesi Valve Stem Seal Ventilschaft Queue de soupape	
						
						<b>21201011</b> 35x50x8 RD
<b>61490025</b> 22441-22012	<b>61490013</b> 21451-21010	<b>61490018</b> 28411-26600  <b>61490016</b>	<b>61490021</b> 28521-22020	<b>61490017</b> 22224-22000	<b>61490027x12</b> 22224-22000 6x11x6x10,2	<b>21201032</b> 72x96x9 LD

■ : Delik - Çentik

■ : Hole - Notch

■ : Trou - Entaille

NOT: Katalogdaki Orjinal Kodlar Referans Amacıyla Kullanılmıştır.Lütfen COTECH Kodlarını Kullanınız.  
Original codes used for reference only.Please use COTECH codes for orders.

00



Silindir Kapak

Cylinder Head

01



Zylinderkopf

02



Joint de culasse

03



04

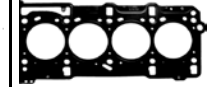

Ltr	MODEL	PS/KW	ENGINE/MOTOR		
1,8 1795	4 CYL ø82 ELANTRA 16V LAVITA 16V MATRIX 16V	122 PS / 90 KW	G4GB G4GB2		61418005 22311-23700 1,20mm FIBER / FIBRE ø84
1,9 1,905	4 CYL ø83 LANTRA (SOCH) 03/98-->10/00	68 PS / 50 KW	XUD9	61204002 0197.H5 61204003 0197.H4 	61204009 0209.S5 1,36 mm 1 61204008 0209.S6 1,40 mm 2 61204007 0209.S7 1,44 mm 3 61204006 0209.S8 1,48 mm 4 61204005 0209.S9 1,53 mm 5 ø 84
2,00 1975	4 CYL ø82 ELANTRA 16V 06/00-->07/06 TUSCON 16V 08/04-->03/10 İ 30 16V COUPE 16V (DOCH)	141 PS / 104 KW 143 PS / 105 KW	G4GC		61418005 22311-23700 1,20mm FIBER / FIBRE ø84
2,0 1997	4 CYL ø85 SONATA 09/88-->08/91 SANTAMO	101 PS / 74 KW	G4P		61500905 MD040533 1,40mm 61500906 MD040533 2,00mm ø86

▲ : İçerikte Bulunmamaktadır...

▲ : Not included in the set

▲ : Non inclus dans la pochette

00: Motor Takım Keçesiz ve Subap Lastiksiz











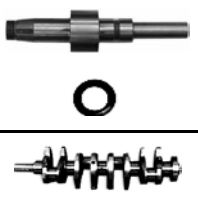
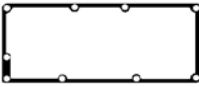





00: Gasket Set Without oil seals Without Valve Stem Seal

01: Motor Takım Keçesiz - Subap Lastikli

01: Gasket set With Valve Stem Seal Without Oil Seals

02: Motor Full Takım Keçeli ve Subap Lastikli

02: Gasket Full Set With oil seals and Valve Stem Seals

Subap Kapak Valve Cover Gasket Zylinderkopfhaube Couverculbut.	Karter Oil Pan Ölwanne Carter d'huile	Emme Manifold Intake Manifold Ansaug Admission	Egzoz Manifold Exhaust Manifold Auspuffkrümmer Collecteur D'echappement	Eksoz Boğaz Exhaust Pipe Auspuff Kehle	Supap Keçesi Valve Stem Seal Ventilschaft Queue de soupape	
						
 <p>61203525 0249.46 0249.91</p>	 <p>61203013 0304.34</p>  <p>61203014 93501565</p>	 <p>61203116x2 9456044080</p>  <p>61203018x2 91508659</p>  <p>61203021 0348.30 0348.CD</p>	 <p>61205019 1721.01 7810024000</p>  <p>61203120x2 0349.47 93010402</p>	 <p>60107027x8 0956.22 8x10,8/14,2x10</p>	<p>21201011x2 35x50x8 WD</p> <p>21201019 42x62x8 RD</p> <p>21201040 90x110x7 LD</p>	

■ : Delik - Çentik

■ : Hole - Notch

■ : Trou - Entaille

NOT: Katalogdaki Orijinal Kodlar Referans Amacıyla Kullanılmıştır.Lütfen COTECH Kodlarını Kullanınız.  
Original codes used for reference only.Please use COTECH codes for orders.

00  
01  
02  
03  
04



Silindir Kapak  
Cylinder Head  
Zylinderkopf  
Joint de culasse



Ltr	MODEL	PS/KW	ENGINE/MOTOR		
2,0 1997	<b>4 CYL ø85</b> SONATA 16V 06/98--> TRAJET 16V SANTA FE 16V (DOCH)	136 PS / 100 KW 131 PS / 96 KW	G4BP G4JP-EG G4JP-G G43P		 <b>61510005</b> 22311-38100 1,20mm FIBER / FIBRE ø86
2,4 2359	<b>4 CYL ø88</b> SONATA NF 16V 01/05--> (DOCH)	162 PS / 119 KW	G4KC		 <b>61419005</b> 22311-25211 1,20mm FIBER / FIBRE <b>61419006</b> 22311-25211 1,80mm FIBER / FIBRE ø90
2,4 2351	<b>4 CYL ø86,5</b> SONATA EF 16V 99-->01 SANTA FE 16V (DOCH)	135 PS / 99 KW 146 PS / 100 KW	G4JS2		 <b>61510205</b> 22311-38200 1,20mm FIBER/FIBRE
2,5 2476	<b>4 CYL ø91</b> H100 D 12/94-->03/00 H100 (AU) 10/97-->04/04 H1 H100TD H1 TD H1 TCI GALLOPER TD LIBERO LEBERO TCI	78PS / 57 KW 80 PS / 59 KW 99 PS / 73 KW 101 PS / 74 KW	D4BA/X D4BF D4BH 4D56TCI D4BF/D4BH 4D56	<b>61450001</b> MD050092  <b>61450002</b> MD050092	 <b>61450005</b> MD050545 1,80mm ø92,5
2,5 2497	<b>4 CYL ø91</b> H-1 CRDI 08/03-->04/04	140 PS / 103 KW	D4CB		 <b>61415505</b> 22311-4A000 1,40mm FIBER / FIBRE ø92,5

▲ : İçerikte Bulunmamaktadır...

▲ : Not included in the set

▲ : Non inclus dans la pochette

00: Motor Takım Keçesiz ve Subap Lastiksiz









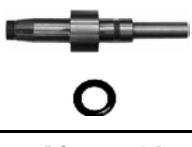
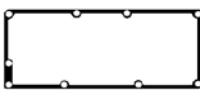

00: Gasket Set Without oil seals Without Valve Stem Seal

01: Motor Takım Keçesiz - Subap Lastikli

01: Gasket set With Valve Stem Seal Without Oil Seals

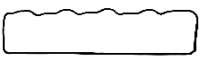
02: Motor Full Takım Keçeli ve Subap Lastikli

02: Gasket Full Set With oil seals and Valve Stem Seals

Subap Kapak Valve Cover Gasket Zylinderkopfhaube Couvre-culbut.	Karter Oil Pan Ölwanne Carter d'huile	Emme Manifold Intake Manifold Ansaug Admission	Egzoz Manifold Exhaust Manifold Auspuffkrümmer Collecteur D'echappement	Eksoz Boğaz Exhaust Pipe Auspuff Kehle	Supap Keçesi Valve Stem Seal Ventilschaft Queue de soupape	
						
						<b>21201013</b> 35x50x8 RD
<b>61450025</b> MD050312	<b>61450013</b> MD149392	<b>61450021</b> MD050482			<b>61450026x8</b> 8x13x9x13	<b>21201023</b> 44x60x7 RD <b>21201035</b> 80x96x9 LD <b>21201004</b> 25x35x6 <b>21201001</b> 17x28x7

■ : Delik - Çentik

■ : Hole - Notch

■ : Trou - Entaille

NOT: Katalogdaki Orijinal Kodlar Referans Amacıyla Kullanılmıştır.Lütfen COTECH Kodlarını Kullanınız.  
Original codes used for reference only.Please use COTECH codes for orders.

00



Silindir Kapak

Cylinder Head

01



Zylinderkopf

02









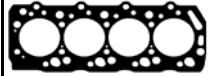

Joint de culasse

03



04



Ltr	MODEL	PS/KW	ENGINE/MOTOR		
2,5 2476	4 CYL ø91 GALLOPER TCi 07/93--> GALLOPER TD GRACE D GRACE TD H-1 TD H100 D H100 TD PORTER TCi PORTER TD STAREX TCi STAREX TD TERRACAN D TERRACAN TD	105 PS / 77 KW 75 PS / 55 KW	D4BA D4BF D4BH D4BX	61470002 1000A901 	 61470005 MD302893 1,60mm 5  61470006 22311-42525 1,55mm 4  61470007 22311-42855 1,50mm 3  61470008 22311-42515 1,45mm 2  ø92,5
2,6 2607	4 CYL ø91 H100 D 04/96-->09/99 H100 (AU ) H1 H100 (AU-M)	85 PS / 60 KW	D4BB	61450001 MD050092  61450002 MD050092	 61450005 MD050545 1,80mm ø92,5
3,3 3342	3 CYL ø92 SONATA V 01/08-->	250 PS / 184 KW	G6DB		61510305  22311-3C140 1,50mm FIBER / FIBRE  22311-3C130 1,50mm FIBER / FIBRE ø93,5

▲ : İçerikte Bulunmamaktadır...

▲ : Not included in the set

▲ : Non inclus dans la pochette

00: Motor Takım Keçesiz ve Subap Lastiksiz











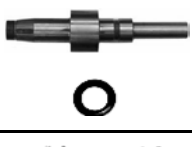
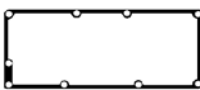

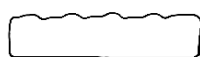

00: Gasket Set Without oil seals Without Valve Stem Seal

01: Motor Takım Keçesiz - Subap Lastikli

01: Gasket set With Valve Stem Seal Without Oil Seals

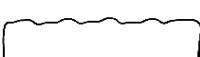
02: Motor Full Takım Keçeli ve Subap Lastikli

02: Gasket Full Set With oil seals and Valve Stem Seals





Subap Kapak Valve Cover Gasket Zylinderkopfhaube Couvre-culbut.	Karter Oil Pan Ölwanne Carter d'huile	Emme Manifold Intake Manifold Ansaug Admission	Egzoz Manifold Exhaust Manifold Auspuffkrümmer Collecteur D'echappement	Eksoz Boğaz Exhaust Pipe Auspuff Kehle	Supap Keçesi Valve Stem Seal Ventilschaft Queue de soupape	
						
						<b>21201013</b> 35x50x8 RD
<b>61450025</b> MD050312	<b>61450013</b> MD149392	<b>61470021</b> 28520-42070			<b>41450026x8</b> 8x13x9x13	<b>21201023</b> 44x60x7 RD
						<b>21201035</b> 80x96x9 LD
						<b>21201004</b> 25x35x6
						<b>21201001</b> 17x28x7
						<b>21201013</b> 35x50x8 RD
<b>61450025</b> MD050312	<b>61450013</b> MD149392	<b>61450021</b> MD050482			<b>41450026x8</b> 8x13x9x13	<b>21201023</b> 44x60x7 RD
						<b>21201035</b> 80x96x9 LD
						<b>21201004</b> 25x35x6
						<b>21201001</b> 17x28x7





■ : Delik - Çentik

■ : Hole - Notch

■ : Trou - Entaille

NOT: Katalogdaki Orijinal Kodlar Referans Amacıyla Kullanılmıştır.Lütfen COTECH Kodlarını Kullanınız.  
Original codes used for reference only.Please use COTECH codes for orders.

00		Silindir Kapak Cylinder Head
01		Zylinderkopf
02		Joint de culasse
03		
04		

Ltr	MODEL	PS/KW	ENGINE/MOTOR	
3,5 3497	6 CYL ø93 TERRACAN 07/01-->10/06 CENTENNIAL 06/00--> XG 350 V6 24 V	195 PS / 143 KW 197 PS / 145 KW	G6CV	<p>61416005</p>  <p>22311-39501 1,20mm FIBER / FIBRE</p>  <p>22311-39502 1,20mm FIBER / FIBRE ø94</p>
3,8 3800	6 CYL AZERA V6 2007-->2010			<p>61520305</p>   <p>ø93,5</p>

▲ : İçerikte Bulunmamaktadır...

▲ : Not included in the set

▲ : Non inclus dans la pochette

00: Motor Takım Keçesiz ve Subap Lastiksiz







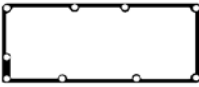

00: Gasket Set Without oil seals Without Valve Stem Seal

01: Motor Takım Keçesiz - Subap Lastikli

01: Gasket set With Valve Stem Seal Without Oil Seals

02: Motor Full Takım Keçeli ve Subap Lastikli

02: Gasket Full Set With oil seals and Valve Stem Seals

<p>Subap Kapak Valve Cover Gasket Zylinderkopfhaube Couvre-culbut.</p> 	<p>Karter Oil Pan Ölwanne Carter d'huile</p> 	<p>Emme Manifold Intake Manifold Ansaug Admission</p> 	<p>Egzoz Manifold Exhaust Manifold Auspuffkrümmer Collecteur D'echappement</p> 	<p>Eksoz Boğaz Exhaust Pipe Auspuff Kehle</p> 	<p>Supap Keçesi Valve Stem Seal Ventilschaft Queue de soupape</p> 	  

■ : Delik - Çentik

■ : Hole - Notch

■ : Trou - Entaille

NOT: Katalogdaki Orijinal Kodlar Referans Amacıyla Kullanılmıştır.Lütfen COTECH Kodlarını Kullanınız.  
Original codes used for reference only.Please use COTECH codes for orders.

00



Silindir Kapak

Cylinder Head

01



Zylinderkopf

02



Joint de culasse

03



04

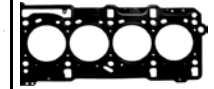

Ltr	MODEL	PS/KW	ENGINE/MOTOR		
2,5 2499	<b>4 CYL ø93</b> DAILY I 01/89--> 06/90-->	75 PS / 55 KW 72 PS / 53 KW 106 PS / 78 KW 109 PS / 80 KW 116 PS / 85 KW 104 PS / 77 KW 103 PS / 72 KW 98 PS / 68 KW	8140.07.2700 8140.07.2701 8140.07.2710 8140.07.2711 8140.07.2712 8140.07.2713 8140.07.3710 8140.07.3711 8140.07.3712 8140.07.3713 8140.21.200 8140.21.212 8140.27S.2801 8140.27S.2811 8140.27S.2885 8140.27S.3811 8140.27.215 8140.27.218		 <b>60138005</b> 98448817 1,50mm <b>60138006</b> 99461499 1,40mm <b>ø95</b>
2,5 2499	<b>4 CYL ø93</b> DAILY II 01/89-->08/98	82 PS / 60 KW	8140.67F.3700 8140.67F.3701 8140.67F.3710 8140.67F.3711 8140.67F.3713		 <b>60147005</b> 98498291 1,80mm <b>60147006</b> 98492581 1,70mm <b>ø95,2</b>
2,8 2799	<b>4 CYL ø94,4</b> DAILY I DAILY II 05/96-->05/99	122 PS / 90 KW	8140.23.3700 8140.23.3701 8140.23.3710 8140.23.3711 8140.23.3713 8140.23.3720 8140.23.3721 8140.23.3730 8140.23.3731 8140.23.3750 8140.23.3751 8140.23.3760 8140.43	<b>60139000</b> 99477116 	 <b>60139005</b> 99458402 1,50mm <b>60139006</b> 99460983 1,40mm <b>60139007</b> 99432353 1,30mm <b>ø96</b>

▲ : İçerikte Bulunmamaktadır...

▲ : Not included in the set

▲ : Non inclus dans la pochette

00: Motor Takım Keçesiz ve Subap Lastiksiz











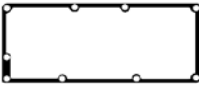

00: Gasket Set Without oil seals Without Valve Stem Seal

01: Motor Takım Keçesiz - Subap Lastikli

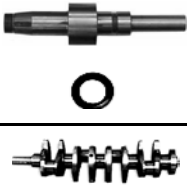
01: Gasket set With Valve Stem Seal Without Oil Seals

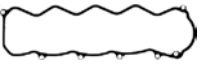
02: Motor Full Takım Keçeli ve Subap Lastikli

02: Gasket Full Set With oil seals and Valve Stem Seals

<p>Subap Kapak Valve Cover Gasket Zylinderkopfhaube Couvre-culbut.</p> 	<p>Karter Oil Pan Ölwanne Carter d'huile</p> 	<p>Emme Manifold Intake Manifold Ansaug Admission</p> 	<p>Egzoz Manifold Exhaust Manifold Auspuffkrümmer Collecteur D'echappement</p> 	<p>Eksoz Boğaz Exhaust Pipe Auspuff Kehle</p> 	<p>Supap Keçesi Valve Stem Seal Ventilschaft Queue de soupape</p> 	
 <p><b>60138045</b> 500388382</p>  <p><b>60138047</b> 500388381</p>	 <p><b>60146066</b> 7301683</p>  <p><b>60138068</b> 500327440</p>	 <p><b>60146019x4</b> 98425767</p>	 <p><b>60147021x4</b> 98434020</p>			

■ : Delik - Çentik

■ : Hole - Notch

■ : Trou - Entaille

NOT: Katalogdaki Orijinal Kodlar Referans Amacıyla Kullanılmıştır.Lütfen COTECH Kodlarını Kullanınız.  
Original codes used for reference only.Please use COTECH codes for orders.

00  
01  
02  
03  
04



Silindir Kapak  
Cylinder Head  
Zylinderkopf  
Joint de culasse

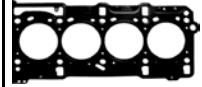

Ltr	MODEL	PS/KW	ENGINE/MOTOR		
2,8 2799	4 CYL ø94,4 DAILY II 05/96-->05/99	103 PS / 76 KW	8140.23.3801 8140.23.3811 8140.23.3821 8140.43B.4300 8140.43B...  8140.43K... 8140.43N... 8140.43N...  8140.43R... 8140.43S...		 <b>60139005</b> 99458402 1,50mm  <b>60139006</b> 99460983 1,40mm  <b>60139007</b> 99432353 1,30mm ø96
2,8 2799	4 CYL ø94,4 DAILY III 05/99-->	105 PS / 77 KW	8140.43C.4000 8140.43C.4005 8140.43C.4020 8140.43C.4021 8140.43C.4025  8140.43C.4026 8140.43C.4030 8140.43C.4031  8140.43C.4035 8140.43C.4036	<b>60139100</b> 500366511 	 <b>60139005</b> 99458402 1,50mm  <b>60139006</b> 99460983 1,40mm  <b>60139007</b> 99432353 1,30mm ø96
2,8 2799	4 CYL ø94,4 DAILY II DAILY III 09/98-->05/99	84 PS / 62 KW	8140.63.4000 8140.63.4020 8140.63.3711 8140.63.3713 8140.63.3721 8140.63.3723		 <b>60147105</b> 500306172 1,80mm  <b>60147106</b> 500306171 1,70mm  <b>60147107</b> 500306170 1,60mm ø96

▲ : İçerikte Bulunmamaktadır...

▲ : Not included in the set

▲ : Non inclus dans la pochette

00: Motor Takım Keçesiz ve Subap Lastiksiz











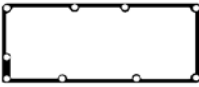

00: Gasket Set Without oil seals Without Valve Stem Seal

01: Motor Takım Keçesiz - Subap Lastikli

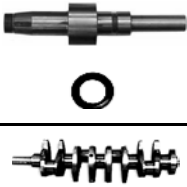
01: Gasket set With Valve Stem Seal Without Oil Seals

02: Motor Full Takım Keçeli ve Subap Lastikli

02: Gasket Full Set With oil seals and Valve Stem Seals

<p>Subap Kapak Valve Cover Gasket Zylinderkopfhaube Couvre-culbut.</p> 	<p>Karter Oil Pan Ölwanne Carter d'huile</p> 	<p>Emme Manifold Intake Manifold Ansaug Admission</p> 	<p>Egzoz Manifold Exhaust Manifold Auspuffkrümmer Collecteur D'echappement</p> 	<p>Eksoz Boğaz Exhaust Pipe Auspuff Kehle</p> 	<p>Supap Keçesi Valve Stem Seal Ventilschaft Queue de soupape</p> 	
 <p><b>60138045</b> 500388382</p>  <p><b>60138047</b> 500388381</p>	 <p><b>60138068</b> 98446492</p>	 <p><b>60146019x4</b> 98425767</p>	 <p><b>60147021x4</b> 98434020</p>			

■ : Delik - Çentik

■ : Hole - Notch

■ : Trou - Entaille

NOT: Katalogdaki Orijinal Kodlar Referans Amacıyla Kullanılmıştır.Lütfen COTECH Kodlarını Kullanınız.  
Original codes used for reference only.Please use COTECH codes for orders.

00



Silindir Kapak

Cylinder Head

01



Zylinderkopf

02



Joint de culasse

03

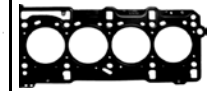

04



Ltr	MODEL	PS/KW	ENGINE/MOTOR	
	<b>3 CYL ø110</b> 400 500			 <b>61316005</b> 8823404 ø114
4,2 4156	<b>4 CYL ø105</b> LEONCINO 1960-->1969		C01D	 <b>61315005</b> 8804253 ø109
4,6 4561	<b>4 CYL ø110</b> 65NC-OM65- 1972-> 75NC-OM75 1973-> 70NC-OM70 1973-> OM50-OM55 1973->1978 329 A BUS 1973->1986 CERBIATTO 1969-> DAINO 1969-> LEONCINO 1969-> LUPETTO 1969-> <b>5,0</b> 4941 TIGROTTO 1969-> LEONCINO 1969-> LUPETTO 1969->		C03 C03 C03 C03 C03 C03 C03 C03 C03 C03 C03	 <b>61411005</b> 8818558 ø114
4,0 4397 <b>5,0</b> 4941	<b>4 CYL ø108 / 110</b> CERBIATTO 1962->1969 DAINO 1962->1969 LEONCINO 1962->1969 TIGROTTO 1962->1969		C02D C03D C02D C03D	 <b>61314005</b> 8807696 ø112
11,6 11548	<b>6 CYL ø130</b> 300 BUS 1968-> 306 BUS 1968-> 682 N3/T3 1962->1976 682 N4/T4 1968->		203H61 203H61 203A/61 203A/61	 <b>61318006</b> 4868477 ø134

▲ : İçerikte Bulunmamaktadır...

▲ : Not included in the set

▲ : Non inclus dans la pochette

00: Motor Takım Keçesiz ve Subap Lastiksiz

00: Gasket Set Without oil seals Without Valve Stem Seal

01: Motor Takım Keçesiz - Subap Lastikli

01: Gasket set With Valve Stem Seal Without Oil Seals

02: Motor Full Takım Keçeli ve Subap Lastikli

02: Gasket Full Set With oil seals and Valve Stem Seals



00



Silindir Kapak

Cylinder Head

01



Zylinderkopf

02







Joint de culasse

03



04



Ltr	MODEL	PS/KW	ENGINE/MOTOR		
2,5 2490	3 CYL ø98 1020			61000900 RE-13255 RE-501574	 61000905 R-98460 R-52790 ø115
2,6 2697	3 CYL ø102 1030 1035 1520			61000903 AR102295	
2,9 2938	3 CYL ø106,5 1630 1635 330				
2,5 2490	3 CYL ø98 1020 JD300 JD301 JD350 JD820 JD830		3152 D	61001000 RE-16912	 61001005 R-98460 R-52790 ø119
2,6 2697	3 CYL ø102 1030 1035 1520 1530 204 JD302		3164 D	61001000 RE-16912	 61001005 R-98460 R-52790 ø119
2,9 2938	3 CYL ø106,5 1630 1635 1040 1140 330 2040 2240 5105 5200 5300		3179 D 3029 D 3029 D 3029 T	61001000 RE-16912	 61001005 R-98460 R-52790 ø119
3,3 3310	4 CYL ø98 2020	4202DL01		62434000 AR-103456 RE-38558	 62434005 R-52790 R-98461 ø115

▲ : İçerikte Bulunmamaktadır...

▲ : Not included in the set

▲ : Non inclus dans la pochette

00: Motor Takım Keçesiz ve Subap Lastiksiz











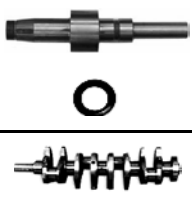
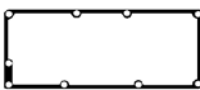



00: Gasket Set Without oil seals Without Valve Stem Seal

01: Motor Takım Keçesiz - Subap Lastikli

01: Gasket set With Valve Stem Seal Without Oil Seals

02: Motor Full Takım Keçeli ve Subap Lastikli

02: Gasket Full Set With oil seals and Valve Stem Seals

Subap Kapak Valve Cover Gasket Zylinderkopfhaube Couvre-culbut.	Karter Oil Pan Ölwanne Carter d'huile	Emme Manifold Intake Manifold Ansaug Admission	Egzoz Manifold Exhaust Manifold Auspuffkrümmer Collecteur D'echappement	Eksoz Boğaz Exhaust Pipe Auspuff Kehle	Supap Keçesi Valve Stem Seal Ventilschaft Queue de soupape	
						
<b>61001058</b> R-75729 T-20111	<b>61001010</b> T-24534		<b>61001020x3</b> T-20006			
			<b>61001020x3</b> T-20006			
<b>61001058</b> R-75729	<b>61001010</b> T-24534		<b>61001020x3</b> T-20006			
			<b>61001020x3</b> T-20006			
<b>61001058</b> R-75729	<b>61001010</b> T-24534		<b>61001020x3</b> T-20006			
			<b>61001020x3</b> T-20006			
<b>61001058</b> R-75729	<b>61001010</b> T-24534		<b>61001020x3</b> T-20006			
			<b>61001020x4</b> T-20006			
<b>61002033</b> T-20075 R-73521	<b>61002008</b> R-49515 R-123353		<b>61001020x4</b> T-20006			

■ : Delik - Çentik

■ : Hole - Notch

■ : Trou - Entaille

NOT: Katalogdaki Orijinal Kodlar Referans Amacıyla Kullanılmıştır.Lütfen COTECH Kodlarını Kullanınız.  
Original codes used for reference only.Please use COTECH codes for orders.

00



Silindir Kapak  
Cylinder Head

01



Zylinderkopf

02



Joint de culasse

03



04



Ltr	MODEL	PS/KW	ENGINE/MOTOR		
3,3 3310	4 CYL ø98 2020 2510 JD400 JD440 JD450 JD480		4202DL01/4180	61002000 AR-71998 RE-38857 61002003 AR-71992 RE-38851	 61002005 R-92425 R-56573 ø119
3,5 3590	4 CYL ø102 2120 2030 2035		4219 D	62434000 AR-103456 RE-38558 62434003 RE-38847	 62434005 R-52790 R-98461 ø115
3,5 3310	4 CYL ø102 2120 2030 2035 2270; 2280 2340; 2420 JD310; JD401		4219 D	61002000 AR-71998 RE-38857 61002003 AR-71992 RE-38851	 61002005 R-92425 R-56573 ø119
3,9 3918	4 CYL ø106,5 2130 2135 935			62434000 AR-103456 RE-38558 62434003 RE-38847	 62434005 R-52790 R-98461 ø115
3,9 3918	4 CYL ø106,5 2130; 2135 1640; 1840; 2040 2140; 2650 2850; 2250; 2450 935; 940 JD4400; JD540B JD550; JD555		4239 D 4239 T	61002000 AR-71998 RE-38857 61002003 AR-71992 RE-38851	 61002005 R-92425 R-56573 ø119

▲ : İçerikte Bulunmamaktadır...

▲ : Not included in the set

▲ : Non inclus dans la pochette

00: Motor Takım Keçesiz ve Subap Lastiksiz











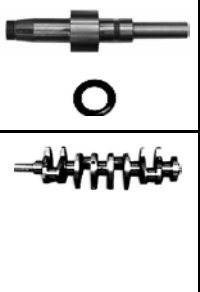
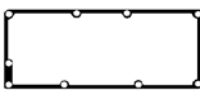









00: Gasket Set Without oil seals Without Valve Stem Seal

01: Motor Takım Keçesiz - Subap Lastikli

01: Gasket set With Valve Stem Seal Without Oil Seals

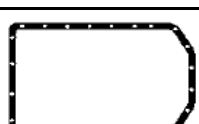
02: Motor Full Takım Keçeli ve Subap Lastikli

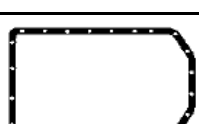
02: Gasket Full Set With oil seals and Valve Stem Seals

Subap Kapak Valve Cover Gasket Zylinderkopfhaube Couvre-culbut.	Karter Oil Pan Ölwanne Carter d'huile	Emme Manifold Intake Manifold Ansaug Admission	Egzoz Manifold Exhaust Manifold Auspuffkrümmer Collecteur D'echappement	Eksoz Boğaz Exhaust Pipe Auspuff Kehle	Supap Keçesi Valve Stem Seal Ventilschaft Queue de soupape	
						
 <b>61002033</b> T-20075 R-73521	 <b>61002008</b> R-49515 R-123353		 <b>61001020x4</b> T-20006			
 <b>61002033</b> T-20075 R-73521	 <b>61002008</b> R-49515 R-123353		 <b>61001020x4</b> T-20006			
 <b>61002033</b> T-20075 R-73521	 <b>61002008</b> R-49515 R-123353		 <b>61001020x4</b> T-20006			
 <b>61002033</b> T-20075 R-73521	 <b>61002008</b> R-49515 R-123353		 <b>61001020x4</b> T-20006			
 <b>61002033</b> T-20075 R-73521	 <b>61002008</b> R-49515 R-123353		 <b>61001020x4</b> T-20006			

■ : Delik - Çentik

■ : Hole - Notch

■ : Trou - Entaille

NOT: Katalogdaki Orijinal Kodlar Referans Amacıyla Kullanılmıştır.Lütfen COTECH Kodlarını Kullanınız.  
Original codes used for reference only.Please use COTECH codes for orders.

00



01



02



03



04



Silindir Kapak  
Cylinder Head  
Zylinderkopf  
Joint de culasse

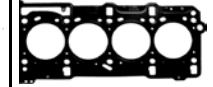

Ltr	MODEL	PS/KW	ENGINE/MOTOR		
3,7	4 CYL ø101,6 JD500 3010 JD510 3020  4 CYL ø101,8 JD500A JD500B JD500C JD510		3010 3010 3020 3020  227/4270D 227/4270D 227/4270D 227/4270D	62433400 AR-53033  62433403 AR-53032	 62433405 R-45616 ø122,5
3,7	4 CYL ø101,6 JD510 3020		3020	62433300 AR-53035  62433303 AR-53034	 62433305 R-48292 ø124,5

▲ : İçerikte Bulunmamaktadır...

▲ : Not included in the set

▲ : Non inclus dans la pochette

00: Motor Takım Keçesiz ve Subap Lastiksiz











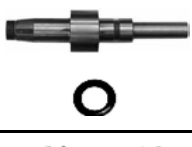
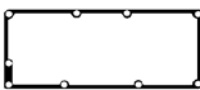

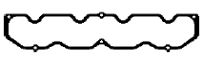
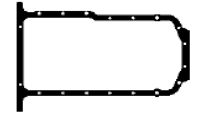

00: Gasket Set Without oil seals Without Valve Stem Seal

01: Motor Takım Keçesiz - Subap Lastikli

01: Gasket set With Valve Stem Seal Without Oil Seals

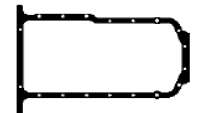
02: Motor Full Takım Keçeli ve Subap Lastikli

02: Gasket Full Set With oil seals and Valve Stem Seals

Subap Kapak Valve Cover Gasket Zylinderkopfhaube Couvre-culbut.	Karter Oil Pan Ölwanne Carter d'huile	Emme Manifold Intake Manifold Ansaug Admission	Egzoz Manifold Exhaust Manifold Auspuffkrümmer Collecteur D'echappement	Eksoz Boğaz Exhaust Pipe Auspuff Kehle	Supap Keçesi Valve Stem Seal Ventilschaft Queue de soupape	
						
 <b>62433334</b> R-49865	 <b>62433308</b> R-71917	 <b>62433718x2</b> R-26297	 <b>62432122x2</b> R-83020  <b>62432121x2</b> R-83021			
 <b>62433334</b> R-49865	 <b>62433308</b> R-71917	 <b>62433718x2</b> R-26297	 <b>62432122x2</b> R-83020  <b>62432121x2</b> R-83021			

■ : Delik - Çentik

■ : Hole - Notch

■ : Trou - Entaille

NOT: Katalogdaki Orjinal Kodlar Referans Amacıyla Kullanılmıştır.Lütfen COTECH Kodlarını Kullanınız.  
Original codes used for reference only.Please use COTECH codes for orders.

00



Silindir Kapak

Cylinder Head

01



Zylinderkopf

02



Joint de culasse

03



04

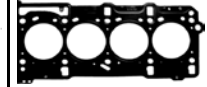

Ltr	MODEL	PS/KW	ENGINE/MOTOR		
4,5 4500	4 CYL ø106 280 310G 340D 344E 410C 410D 440C 450 450H 550 H 650 H 2630 - 2640 - 5410 5420 N 5420 5510 N 5510 - 5520 - 6010 5520 N 6020 6110 6120 6205 6210 6220 6310 6400 6405 6410 6415 6505 6510 6700		4045 D 4045 T 4045 H 4045 HL 4045 TF	62432000 RE-501455  62432003 RE-660282	  62432005 R-116515 ø119
5,4 5395	6 CYL ø102 3120; 3130; 3135 2840; 630; 730; 950 960; 970 JD303; JD444; JD540 JD544; JD570; JD482 484; 499; 699 4420; 6600		6329 D	62432600 RE-527022  61003003 AR-71994 RE-38852	  61003005 R-59449 ø119

▲ : İçerikte Bulunmamaktadır...

▲ : Not included in the set

▲ : Non inclus dans la pochette

00: Motor Takım Keçesiz ve Subap Lastiksiz











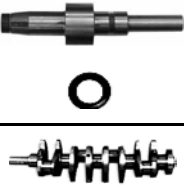
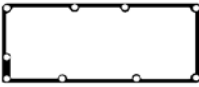
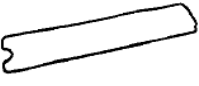

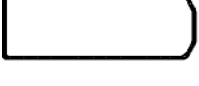

00: Gasket Set Without oil seals Without Valve Stem Seal

01: Motor Takım Keçesiz - Subap Lastikli

01: Gasket set With Valve Stem Seal Without Oil Seals

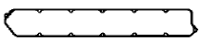
02: Motor Full Takım Keçeli ve Subap Lastikli

02: Gasket Full Set With oil seals and Valve Stem Seals

Subap Kapak Valve Cover Gasket Zylinderkopfhaube Couverculbut.	Karter Oil Pan Ölwanne Carter d'huile	Emme Manifold Intake Manifold Ansaug Admission	Egzoz Manifold Exhaust Manifold Auspuffkrümmer Collecteur D'echappement	Eksoz Boğaz Exhaust Pipe Auspuff Kehle	Supap Keçesi Valve Stem Seal Ventilschaft Queue de soupape	
    <b>62432025</b> R-123542	    <b>61002008</b> R-49515 R-123353    <b>62432008</b> R-123352			    <b>61003017</b> R-55509 R-89879    <b>62432821x4</b> R-521439		
  <b>61003033</b> T-20467 R-75728	  <b>61003008</b> T-20205 R-97349	  <b>61001088x2</b> T-20159	  <b>61001020x6</b> T-20006    <b>61003017</b> R-55509 R-89879			

■ : Delik - Çentik

■ : Hole - Notch

■ : Trou - Entaille

NOT: Katalogdaki Orjinal Kodlar Referans Amacıyla Kullanılmıştır.Lütfen COTECH Kodlarını Kullanınız.  
 Original codes used for reference only.Please use COTECH codes for orders.

00  
01  
02  
03  
04



Silindir Kapak  
Cylinder Head  
Zylinderkopf  
Joint de culasse



Ltr	MODEL	PS/KW	ENGINE/MOTOR		
5,4 5395	6 CYL ø102 3120 3130 3135 630 730 950 960; 970			61002900 Motor Takım Conta Gasket Set  61002903 Motor Üst Takım Gasket Head Set	 61002905 R-52791 ø115
5,4 5395	6 CYL ø102 955 4240 4440 4040 965 955H 985 1065 1068H 4040S 4240S		3029 D 3029 T 6359 D 6359 T	61003000 AR-74367 AR-102268 AR-97786  61003003 RE-38852 AR-71994	 61003005 R-59449 ø119
5,9 5880	6 CYL ø106,5 3140; 3040 3640; 4040 960; 970; 975 2940; 3050 3350; 3650 JD544B; JD640; JD655 JD670; JD672; JD750 JD755		6359 D 6414 D	62432600 RE-527022  61003003 AR-71994 RE-38852	 61003005 R-59449 ø119
6,6 6600	6 CYL ø101,6 JD600 4010  6 CYL ø104,7 JD600 4020  6 CYL ø108 7700; 7720; JD644 341; 362; 6620; 6622  << 214999		4010/301 4010  381 4020  6404 6404	62424100 AR-53626  62434103 AR-53625	 62434105 R-45615 ø122,5

▲ : İçerikte Bulunmamaktadır...

▲ : Not included in the set

▲ : Non inclus dans la pochette

00: Motor Takım Keçesiz ve Subap Lastiksiz









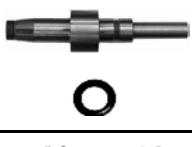
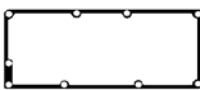

00: Gasket Set Without oil seals Without Valve Stem Seal

01: Motor Takım Keçesiz - Subap Lastikli

01: Gasket set With Valve Stem Seal Without Oil Seals

02: Motor Full Takım Keçeli ve Subap Lastikli

02: Gasket Full Set With oil seals and Valve Stem Seals

Subap Kapak Valve Cover Gasket Zylinderkopfhaube Couvre-culbut.	Karter Oil Pan Ölwanne Carter d'huile	Emme Manifold Intake Manifold Ansaug Admission	Egzoz Manifold Exhaust Manifold Auspuffkrümmer Collecteur D'echappement	Eksoz Boğaz Exhaust Pipe Auspuff Kehle	Supap Keçesi Valve Stem Seal Ventilschaft Queue de soupape	
						
<b>61003033</b> T-20467 R-75728	<b>61003008</b> T-20205 R-97349	<b>61001088x2</b> T-20159	<b>61001020x6</b> T-20006  <b>61003017</b> R-55509 R-89879			
<b>61003033</b> T-20467 R-75728	<b>61003008</b> T-20205 R-97349	<b>61001088x2</b> T-20159	<b>61001020x6</b> T-20006  <b>61003017</b> R-55509 R-89879			
<b>61003033</b> T-20467 R-75728	<b>61003008</b> T-20205 R-97349	<b>61001088x2</b> T-20159	<b>61001020x6</b> T-20006  <b>61003017</b> R-55509 R-89879			
<b>62432134</b> R-49866	<b>62432108</b> R-71918 R-520583	<b>62433718x3</b> R-26297	<b>62432122x2</b> R-83020  <b>62432121x2</b> R-83021			

■ : Delik - Çentik

■ : Hole - Notch

■ : Trou - Entaille

NOT: Katalogdaki Orijinal Kodlar Referans Amacıyla Kullanılmıştır.Lütfen COTECH Kodlarını Kullanınız.  
Original codes used for reference only.Please use COTECH codes for orders.

00



Silindir Kapak

Cylinder Head

01



Zylinderkopf

02



Joint de culasse

03



04



Ltr	MODEL	PS/KW	ENGINE/MOTOR		
6,6 6600	6 CYL ø101,6 JD600 4010  6 CYL ø104,7 JD600 4020  6 CYL ø108 7700; 7720; JD644 341; 362; 6620; 6622  >>215000-335845		4010/301 4010  381 4020  6404 6404	62433600 AR-53631  62433603 AR-53630	  62432105 R-48291 ø124,5
6,6 6600	6 CYL ø108 4520 JD690B; JD693B JD740 ; 4040; 4249 4440; 5440 5640; 7020 7720; 4430 4620; 4630; 4320		4520/6404A/D/T	62432100 RG-27875  62432103 RG-27876 AR-63270	  62432105 R-48291 ø124,5

▲ : İçerikte Bulunmamaktadır...

▲ : Not included in the set

▲ : Non inclus dans la pochette

00: Motor Takım Keçesiz ve Subap Lastiksiz











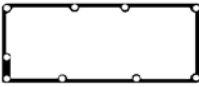

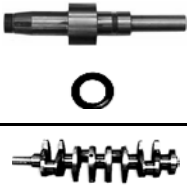
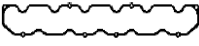

00: Gasket Set Without oil seals Without Valve Stem Seal

01: Motor Takım Keçesiz - Subap Lastikli

01: Gasket set With Valve Stem Seal Without Oil Seals

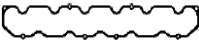
02: Motor Full Takım Keçeli ve Subap Lastikli

02: Gasket Full Set With oil seals and Valve Stem Seals

<p>Subap Kapak Valve Cover Gasket Zylinderkopfhaube Couvre-culbut.</p> 	<p>Karter Oil Pan Ölwanne Carter d'huile</p> 	<p>Emme Manifold Intake Manifold Ansaug Admission</p> 	<p>Egzoz Manifold Exhaust Manifold Auspuffkrümmer Collecteur D'echappement</p> 	<p>Eksoz Boğaz Exhaust Pipe Auspuff Kehle</p> 	<p>Supap Keçesi Valve Stem Seal Ventilschaft Queue de soupape</p> 	
 <p><b>62432134</b> R-49866</p>	 <p><b>62432108</b> R-71918 R-520583</p>	 <p><b>62433718x3</b> R-26297</p>	 <p><b>62432122x2</b> R-83020</p>  <p><b>62432121x2</b> R-83021</p>			
 <p><b>62432134</b> R-49866</p>	 <p><b>62432108</b> R-71918 R-520583</p>	 <p><b>62433718x3</b> R-26297</p>	 <p><b>62432122x2</b> R-83020</p>  <p><b>62432121x2</b> R-83021</p>			

■ : Delik - Çentik

■ : Hole - Notch

■ : Trou - Entaille

NOT: Katalogdaki Orjinal Kodlar Referans Amacıyla Kullanılmıştır.Lütfen COTECH Kodlarını Kullanınız.  
Original codes used for reference only.Please use COTECH codes for orders.

00



Silindir Kapak

Cylinder Head

01



Zylinderkopf

02



Joint de culasse

03



04



Ltr	MODEL	PS/KW	ENGINE/MOTOR		
6,8	6 CYL ø106				
6800	JD670	Tractor :			
	JD755	6215 / 6320 / 6420	6068 H	62432200	
	LX100-2	6510 / 6515 / 6520	6068 T	RE-501456	62432205
	42.14	6605 / 6610 / 6615			R-116516
	360DC	6715 / 6810 / 6820		62432203	ø119
	360DG	6910S / 6920 / 6920S		RE-66083	
	430B	7220 / 7320 / 7400			
	460DC	7420 / 7510 / 7520			
	460DG	7610 / 7710 / 7810			
	540G	6505 / 6603 / 6620			
	544J	6910 / 7210 / 7410 / 7600			
	548G				
	624EH				
	624G				
	640E				
	640G				
	648G				
	653E				
	653G				
	690				
	700H				
	700J				
	710D				
	710J				
	750C				
	750J				
	790E				
	850J				
	1070D				
	1110D				
	1410D				
	1450				
	1490D				
	1550				
	2054				
	2054				
	2254				
	2254				
	4710				
	4990				
	4995				
	7455				
	7460				
	9400				
	9410				
	9540				
	9560				
	9580				
	9935				

▲ : İçerikte Bulunmamaktadır...

▲ : Not included in the set

▲ : Non inclus dans la pochette

00: Motor Takım Keçesiz ve Subap Lastiksiz







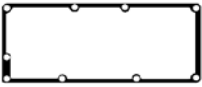
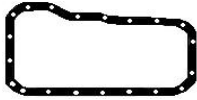

00: Gasket Set Without oil seals Without Valve Stem Seal

01: Motor Takım Keçesiz - Subap Lastikli

01: Gasket set With Valve Stem Seal Without Oil Seals

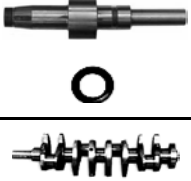
02: Motor Full Takım Keçeli ve Subap Lastikli

02: Gasket Full Set With oil seals and Valve Stem Seals

<p>Subap Kapak Valve Cover Gasket Zylinderkopfhaube Couvre-culbut.</p> 	<p>Karter Oil Pan Ölwanne Carter d'huile</p> 	<p>Emme Manifold Intake Manifold Ansaug Admission</p> 	<p>Egzoz Manifold Exhaust Manifold Auspuffkrümmer Collecteur D'echappement</p> 	<p>Eksoz Boğaz Exhaust Pipe Auspuff Kehle</p> 	<p>Supap Keçesi Valve Stem Seal Ventilschaft Queue de soupape</p> 	
 <p><b>62432225</b> R-123543</p>	 <p><b>61003008</b> T-20205 R-123354</p>		 <p><b>61003017</b> R-55509 R-89879</p>  <p><b>62432821x6</b> R-521439</p>			

■ : Delik - Çentik

■ : Hole - Notch

■ : Trou - Entaille

NOT: Katalogdaki Orijinal Kodlar Referans Amacıyla Kullanılmıştır.Lütfen COTECH Kodlarını Kullanınız.  
Original codes used for reference only.Please use COTECH codes for orders.

00



Silindir Kapak

Cylinder Head

01



Zylinderkopf

02



Joint de culasse

03



04



Ltr MODEL PS/KW ENGINE/MOTOR

Ltr	MODEL	PS/KW	ENGINE/MOTOR		
7,6	6 CYL ø116				
7600	220LC		6076	<b>62433700</b>	
	540E		6076 A	RE-524624	
	548E		6076 H	AR-101276	
	548G		6076 T		
	640E			<b>62433703</b>	
	640G			RE-526730	
	648E			RG-27884	
	648G				
	740E				
	740G				
	748G				
	1185				
	2440				
	4255				
	4455				
	4555				
	4560				
	4755				
	4760				
	4955				
	4960				
	6076-AG				
	7700				
	7700				
	7800				
	8100				
	8200				
	8300				
	8560				
	8570				
	9500				
	9600				
	9960				
	9965				



**62433705**

RE-47336

R-66065

ø129

▲ : İçerikte Bulunmamaktadır...

▲ : Not included in the set

▲ : Non inclus dans la pochette

00: Motor Takım Keçesiz ve Subap Lastiksiz











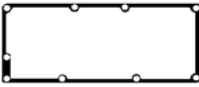

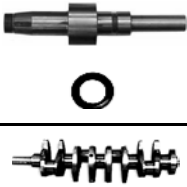
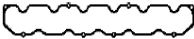

00: Gasket Set Without oil seals Without Valve Stem Seal

01: Motor Takım Keçesiz - Subap Lastikli

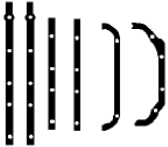
01: Gasket set With Valve Stem Seal Without Oil Seals

02: Motor Full Takım Keçeli ve Subap Lastikli

02: Gasket Full Set With oil seals and Valve Stem Seals

<p>Subap Kapak Valve Cover Gasket Zylinderkopfhaube Couvre-culbut.</p> 	<p>Karter Oil Pan Ölwanne Carter d'huile</p> 	<p>Emme Manifold Intake Manifold Ansaug Admission</p> 	<p>Egzoz Manifold Exhaust Manifold Auspuffkrümmer Collecteur D'echappement</p> 	<p>Eksoz Boğaz Exhaust Pipe Auspuff Kehle</p> 	<p>Supap Keçesi Valve Stem Seal Ventilschaft Queue de soupape</p> 	
 <p><b>62432134</b> R-49866</p>	 <p><b>62432108</b> R-71918 R-520583</p>  <p><b>62432109</b> R-49377 R-521228</p>	 <p><b>62433819x3</b> R-130573</p>	 <p><b>62432122x2</b> R-83020</p>  <p><b>62432121x2</b> R-83021</p>	 <p><b>61003017</b> R-55509 R-89879</p>  <p><b>62432518</b> R-92097 R-123583</p>		

■ : Delik - Çentik

■ : Hole - Notch

■ : Trou - Entaille

NOT: Katalogdaki Orijinal Kodlar Referans Amacıyla Kullanılmıştır.Lütfen COTECH Kodlarını Kullanınız.  
Original codes used for reference only.Please use COTECH codes for orders.

00



Silindir Kapak

Cylinder Head

01



Zylinderkopf

02



Joint de culasse

03



04



Ltr	MODEL	PS/KW	ENGINE/MOTOR		
7,6 7600	6 CYL ø116 Series 500 644C 644D 690 762A 762B 770 770A 770B 4050 4250 4350 4440 4450 4640 4650 4755 4760 4840 4850 4955 4960 5720 5730 6620 6622 7720 8430 8440 8450 8560 8820 9940 9950		6466 A 6466 T	62433800 RE-524404  62433803 RE-524409	  62433705 RE-47336 R-66065 ø129
8,7 8700	6 CYL ø120 JD644B JD646 JD646B Series 770 770A 772A		6531 A 6531 T	62433900 RE-524149 RE-17050  62433903 RE-524148 AR-67510	  62433905 R-78513 ø138

▲ : İçerikte Bulunmamaktadır...

▲ : Not included in the set

▲ : Non inclus dans la pochette

00: Motor Takım Keçesiz ve Subap Lastiksiz











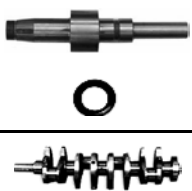
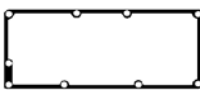





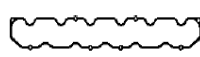
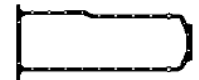
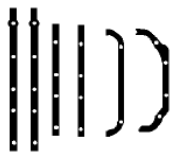

00: Gasket Set Without oil seals Without Valve Stem Seal

01: Motor Takım Keçesiz - Subap Lastikli

01: Gasket set With Valve Stem Seal Without Oil Seals

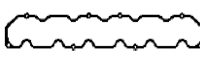
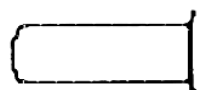
02: Motor Full Takım Keçeli ve Subap Lastikli

02: Gasket Full Set With oil seals and Valve Stem Seals

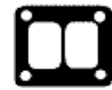
Subap Kapak Valve Cover Gasket Zylinderkopfhaube Couvre-culbut.	Karter Oil Pan Ölwanne Carter d'huile	Emme Manifold Intake Manifold Ansaug Admission	Egzoz Manifold Exhaust Manifold Auspuffkrümmer Collecteur D'echappement	Eksoz Boğaz Exhaust Pipe Auspuff Kehle	Supap Keçesi Valve Stem Seal Ventilschaft Queue de soupape	
						
 <b>62432134</b> R-49866	 <b>62432108</b> R-71918 R-520583   <b>62432109</b> R-49377 R-521228	 <b>62433819x3</b> R-130573   <b>62432118x3</b> R-50397	 <b>62432122x2</b> R-83020   <b>62432121x2</b> R-83021   <b>62432143</b> R-43751	 <b>61003017</b> R-55509 R-89879   <b>62432518</b> R-92097 R-123583		
 <b>62433934</b> R-47365 R-49867	 <b>62433908</b> R-56325 R-520584	 <b>62433517x3</b> R-520521 R-40088	 R-80969x2   R-80970x2  <b>62433521x2</b> R-80970 + R-80969	 <b>61003017</b> R-55509 R-89879		

■ : Delik - Çentik

■ : Hole - Notch

■ : Trou - Entaille

NOT: Katalogdaki Orijinal Kodlar Referans Amacıyla Kullanılmıştır.Lütfen COTECH Kodlarını Kullanınız.  
Original codes used for reference only.Please use COTECH codes for orders.

00



Silindir Kapak

Cylinder Head

01



Zylinderkopf

02



Joint de culasse

03



04



Ltr	MODEL	PS/KW	ENGINE/MOTOR		
8,1	6 CYL ø116				
8100	330CR		6081 T	62432700	
	330LC		6081 H	RE-527579	
	370			RE-506220	
	530B			62432703	62432705
	560D			RE-527550	RE-55475
	608			RE-506222	ø129
	644				
	660D				
	724J				
	740G				
	742J				
	753G				
	762				
	770D				
	850C				
	850J				
	870D				
	2256				
	2258				
	2266				
	6650				
	6710				
	7710				
	7810				
	7820				
	7920				
	8100				
	8110				
	8120				
	8200				
	8210				
	8220				
	8220T				
	8300				
	8310				
	8320				
	8400				
	8420				
	9450				
	9510/SH				
	9550/SH				
	9560				
	9580				
	9610				
	9640				
	9650				
	9650/CTS/STS				
	9660 / 9860 / 9960 / 9970				
	9750 STS				

▲ : İçerikte Bulunmamaktadır...

▲ : Not included in the set

▲ : Non inclus dans la pochette

00: Motor Takım Keçesiz ve Subap Lastiksiz











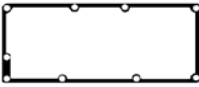

00: Gasket Set Without oil seals Without Valve Stem Seal

01: Motor Takım Keçesiz - Subap Lastikli

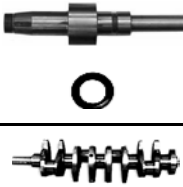
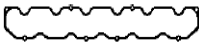
01: Gasket set With Valve Stem Seal Without Oil Seals

02: Motor Full Takım Keçeli ve Subap Lastikli

02: Gasket Full Set With oil seals and Valve Stem Seals

<p>Subap Kapak Valve Cover Gasket Zylinderkopfhaube Couvre-culbut.</p> 	<p>Karter Oil Pan Ölwanne Carter d'huile</p> 	<p>Emme Manifold Intake Manifold Ansaug Admission</p> 	<p>Egzoz Manifold Exhaust Manifold Auspuffkrümmer Collecteur D'echappement</p> 	<p>Eksoz Boğaz Exhaust Pipe Auspuff Kehle</p> 	<p>Supap Keçesi Valve Stem Seal Ventilschaft Queue de soupape</p> 	
 <p><b>62432134</b> R-49866</p>	 <p><b>62432708</b> R-521228</p>	 <p><b>62433819x6</b> R-130573 R-120646</p>	 <p><b>62432122x2</b> R-62776</p>  <p><b>62432121x2</b> R-83021</p>	 <p><b>61003017</b> R-55509 R-89879</p>		

■ : Delik - Çentik

■ : Hole - Notch

■ : Trou - Entaille

NOT: Katalogdaki Orijinal Kodlar Referans Amacıyla Kullanılmıştır.Lütfen COTECH Kodlarını Kullanınız.  
Original codes used for reference only.Please use COTECH codes for orders.

KIA

00



Silindir Kapak  
Cylinder Head

01



Zylinderkopf

02



Joint de culasse

03



04



Ltr	MODEL	PS/KW	ENGINE/MOTOR		
1,0 999 1,1 1086	<b>4 CYL ø66</b> PICANTO 12 V 04/04--> PICANTO EPSILON 12 V ( SOCH )	65 PS / 48 KW 61 PS / 45 KW	G4HE G4HG		 <b>61410405</b> 22311-02760 1,20mm FIBER / FIBRE <b>ø68</b>
1,3 1323	<b>4 CYL ø71</b> PRIDE 01/90--> ( SOCH )	69 PS / 51 KW	B3		 <b>61410605</b> B302-10-271 1,60mm <b>61410606</b> B302-10-271 2,00mm <b>ø74</b>
1,3 1343	<b>4 CYL ø75,5</b> RIO 08/00-->02/05 ( SOCH )	82 PS / 60 KW 75 PS / 50 KW	B3		 <b>61410105</b> OK30C 10 271A 1,20mm FIBER / FIBRE <b>ø76,5</b>
1,4 1399	<b>4 CYL ø75,5</b> RIO 16 V 03/05--> ( DOCH )	97 PS / 71 KW	G4EE		 <b>61410505</b> 22311-26603 1,20mm FIBER / FIBRE <b>ø77</b>

▲ : İçerikte Bulunmamaktadır...

▲ : Not included in the set

▲ : Non inclus dans la pochette

00: Motor Takım Keçesiz ve Subap Lastiksiz









00: Gasket Set Without oil seals Without Valve Stem Seal

01: Motor Takım Keçesiz - Subap Lastikli

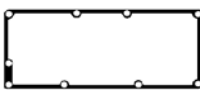
01: Gasket set With Valve Stem Seal Without Oil Seals

02: Motor Full Takım Keçeli ve Subap Lastikli

02: Gasket Full Set With oil seals and Valve Stem Seals

Subap Kapak Valve Cover Gasket Zylinderkopfhaube Couvre-culbut.	Karter Oil Pan Ölwanne Carter d'huile	Emme Manifold Intake Manifold Ansaug Admission	Egzoz Manifold Exhaust Manifold Auspuffkrümmer Collecteur D'echappement	Eksoz Boğaz Exhaust Pipe Auspuff Kehle	Supap Keçesi Valve Stem Seal Ventilschaft Queue de soupape	  
				 		

■ : Delik - Çentik

■ : Hole - Notch

■ : Trou - Entaille

NOT: Katalogdaki Orjinal Kodlar Referans Amacıyla Kullanılmıştır.Lütfen COTECH Kodlarını Kullanınız.  
Original codes used for reference only.Please use COTECH codes for orders.

KIA

00



Silindir Kapak

Cylinder Head

01



Zylinderkopf

02



Joint de culasse

03



04



Ltr	MODEL	PS/KW	ENGINE/MOTOR		
1,4 1396	4 CYL ø77mm CEE'D PRO CEE'D 12/06-->08/08	109 PS / 80 KW	G4FA		<p><b>61510105</b> 22311-2B000 1,20mm FIBER/ FIBRE ø78,5</p>
1,4 1396	4 CYL ø77mm CEE'D PRO CEE'D 09/08-->	109 PS / 80 KW	G4FA		<p><b>61510106</b> 22311-2B003 1,20mm FIBER / FIBRE ø78,5</p>
1,5 1493	4 CYL ø75,5 RIO 16 V ( DOCH ) 09/02-->02/05	97 PS / 71 KW	A3E B3 16V		<p><b>61410205</b> OK30E1 10 271A 1,20mm FIBER / FIBRE ø76,5</p>
1,5 1498	4 CYL ø78 SEPHIA AVELLA LEO MENTOR ( SOCH ) 02/96-->10/97	80 PS / 59 KW	B5		<p><b>61480205</b> OB61L10271A 1,30mm ø79,5</p>
1,6 1597	4 CYL ø78 SEPHIA MENTOR SEPHIA 16 V ( SOCH ) 09/93-->10/97	80 PS / 59 KW	B6		<p><b>61480205</b> OB61L10271A 1,30mm ø79,5</p>
1,6 1599	4 CYL ø76,5 CERATO 16V RIO 16V 02/04-->10/06	105 PS / 77 KW	G4ED		<p><b>61410505</b> 22311-26603 1,20mm FIBER / FIBRE ø77</p>

▲ : İçerikte Bulunmamaktadır...

▲ : Not included in the set

▲ : Non inclus dans la pochette

00: Motor Takım Keçesiz ve Subap Lastiksiz







00: Gasket Set Without oil seals Without Valve Stem Seal

01: Motor Takım Keçesiz - Subap Lastikli

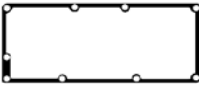
01: Gasket set With Valve Stem Seal Without Oil Seals

02: Motor Full Takım Keçeli ve Subap Lastikli

02: Gasket Full Set With oil seals and Valve Stem Seals

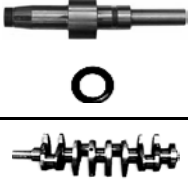
<p>Subap Kapak Valve Cover Gasket Zylinderkopfhaube Couvre-culbut.</p> 	<p>Karter Oil Pan Ölwanne Carter d'huile</p> 	<p>Emme Manifold Intake Manifold Ansaug Admission</p> 	<p>Egzoz Manifold Exhaust Manifold Auspuffkrümmer Collecteur D'echappement</p> 	<p>Eksoz Boğaz Exhaust Pipe Auspuff Kehle</p> 	<p>Supap Keçesi Valve Stem Seal Ventilschaft Queue de soupape</p> 	

■ : Delik - Çentik

■ : Hole - Notch

■ : Trou - Entaille

NOT: Katalogdaki Orijinal Kodlar Referans Amacıyla Kullanılmıştır.Lütfen COTECH Kodlarını Kullanınız.  
Original codes used for reference only.Please use COTECH codes for orders.

00



Silindir Kapak

Cylinder Head

01



Zylinderkopf

02



Joint de culasse

03



04

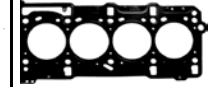

Ltr	MODEL	PS/KW	ENGINE/MOTOR		
1,6 1591	4 CYL ø77mm CEE'D 05/06-->10/08 PRO CEE'D CERATO	122 PS / 90 KW 115 PS / 85 KW 126 PS / 93 KW	G4FC		<p><b>61510105</b> 22311-2B000 1,20mm FIBER/ FIBRE ø78,5</p>
1,6 1591	4 CYL ø77mm CEE'D 11/08--> PRO CEE'D CERATO SOUL CARENS	122 PS / 90 KW 126 PS / 93 KW 115 PS / 85 KW 132 PS / 97 KW	G4FC		<p><b>61510106</b> 22311-2B003 1,20mm FIBER / FIBRE ø78,5</p>
2,0 1975	4 CYL ø82 SPECTRA 16V 04/04--> CERATO 16V SPORTAGE 16V CARENS II 16V CEE'D 16 V ( DOCH )	143 PS / 105 KW 141 PS / 104 KW 139 PS / 102 KW	G4GC		<p><b>61418005</b> 22311-23700 1,20mm FIBER / FIBRE ø84</p>
2,0 1997	4 CYL ø85 OPTIMA 16V 05/01--> MAGENTIS 16V	136 PS / 100 KW	G4JP		<p><b>61510005</b> 22311-38100 1,20mm FIBER / FIBRE ø86</p>
2,0 1998	4 CYL ø86 SPORTAGE ( SOCH ) 04/94-->08/99	95 PS / 70 KW	FE (8V)		<p><b>61420305</b> F202-10-271 1,40mm</p> <p><b>61420306</b> F202-10-271 1,80mm ø87,5</p>

▲ : İçerikte Bulunmamaktadır...

▲ : Not included in the set

▲ : Non inclus dans la pochette

00: Motor Takım Keçesiz ve Subap Lastiksiz

00: Gasket Set Without oil seals Without Valve Stem Seal

01: Motor Takım Keçesiz - Subap Lastikli

01: Gasket set With Valve Stem Seal Without Oil Seals

02: Motor Full Takım Keçeli ve Subap Lastikli

02: Gasket Full Set With oil seals and Valve Stem Seals



KIA

00



Silindir Kapak  
Cylinder Head

01



Zylinderkopf

02



Joint de culasse

03



04

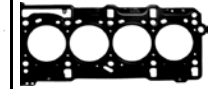

Ltr	MODEL	PS/KW	ENGINE/MOTOR		
2,0 1998	4 CYL ø86 SPORTAGE 16V 04/94--> RETONA 16V CLARUS 16V ( DOCH )	133 PS / 98 KW 128 PS / 94 KW	FE		 <b>61410305</b> OK013 10 271 1,20mm FIBER / FIBRE ø87,5
2,2 2184	4 CYL ø86 BESTA D 02/96--> RETONA TD SPORTAGE TD	65 PS / 48 KW 83 PS / 61 KW	R2 RF	<b>61410000</b> RF01-99-100	 <b>61410005</b> R201-10-271A ø87,5
2,2 2,200	4 CYL ø88,9 CERES 1979-->1981	89 PS / 70 KW	S2	<b>61480000</b> 0527-99-100	 <b>61480005</b> 0527-10-271A ø97
2,4 2,400	4 CYL ø92 CERES 1973-->1977	81 PS / 77 KW	XA XB	<b>61480000</b> 0527-99-100	 <b>61480005</b> 0527-10-271A ø97
2,5 2476	4 CYL ø91,1 PREGIO K2500 BONGO ( SOCH )	94 PS / 69 KW	4DBH	<b>61470002</b> 20910-42E00 	 <b>61470005</b> MD302893 1,60mm 5 <b>61470006</b> 22311-42525 1,55mm 4 <b>61470007</b> 22311-42855 1,50mm 3 <b>61470008</b> 22311-42515 1,45mm 2 ø92,5

▲ : İçerikte Bulunmamaktadır...

▲ : Not included in the set

▲ : Non inclus dans la pochette

00: Motor Takım Keçesiz ve Subap Lastiksiz











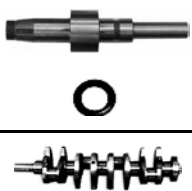
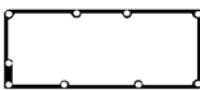





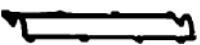





00: Gasket Set Without oil seals Without Valve Stem Seal

01: Motor Takım Keçesiz - Subap Lastikli

01: Gasket set With Valve Stem Seal Without Oil Seals

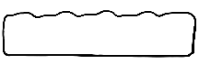
02: Motor Full Takım Keçeli ve Subap Lastikli

02: Gasket Full Set With oil seals and Valve Stem Seals

Subap Kapak Valve Cover Gasket Zylinderkopfhaube Couvre-culbut.	Karter Oil Pan Ölwanne Carter d'huile	Emme Manifold Intake Manifold Ansaug Admission	Egzoz Manifold Exhaust Manifold Auspuffkrümmer Collecteur D'echappement	Eksoz Boğaz Exhaust Pipe Auspuff Kehle	Supap Keçesi Valve Stem Seal Ventilschaft Queue de soupape	
						
						
<b>61410025</b> RF01-10-235	<b>61410013</b> F80110-431	<b>61410019</b> RF0113-111	<b>61410020</b> RF01-13-462			
						
<b>61480025</b> 1456-10-235	<b>61480013</b> 1363-89-104	<b>61480019x4</b> 0636-13-111	<b>61480021x4</b> 0750-13-461 0750-13-461A			
						
<b>61480025</b> 1456-10-235	<b>61480013</b> 1363-89-104	<b>61480019x4</b> 0636-13-111	<b>61480021x4</b> 0750-13-461 0750-13-461A			
						<b>21201013</b> 35x50x8 RD
<b>61450025</b> MD050312	<b>61450013</b> MD149392	<b>61470021</b> 28520-42070			<b>61450026x8</b> 8x13x9x13	<b>21201023</b> 44x60x7 RD
						<b>21201035</b> 80x96x9 LD
						<b>21201004</b> 25x35x6
						<b>21201001</b> 17x28x7

■ : Delik - Çentik

■ : Hole - Notch

■ : Trou - Entaille

NOT: Katalogdaki Orijinal Kodlar Referans Amacıyla Kullanılmıştır.Lütfen COTECH Kodlarını Kullanınız.  
Original codes used for reference only.Please use COTECH codes for orders.

KIA

00



Silindir Kapak  
Cylinder Head

01



Zylinderkopf

02



Joint de culasse

03



04



Ltr	MODEL	PS/KW	ENGINE/MOTOR	
2,5 2497	4 CYL ø91 SORENTO CRDI 16V 08/02--> ( DOCH )	140 PS / 103 KW	D4CB	 <b>61415505</b> 22311-4A000 1,40mm FIBER / FIBRE ø92,5
2,7 2665	4 CYL ø94,5 K2700 10/97--> PREGIO BESTA GS BONGO (SOCH)	80 PS / 59 KW 82 PS / 60 KW	J2	 <b>61411205</b> OK65A10271B 1,60mm FIBER / FIBRE <b>61411206</b> OK65A10271B 2,0mm FIBER / FIBRE ø98,5
2,9 2902	4 CYL ø97,1 SEDONA 16V 10/01--> CARNIVAL TDI 16V CARNIVAL II CRDI 16V	144 PS / 106 KW	KJ	 <b>61510405</b> OK56A10271B 1,50mm FIBER / FIBRE ø100,5
2,9 2956	4 CYL ø98 BESTA GS 07/00--> K300 (SOCH)	85 PS / 63 KW	JTA	 <b>61410905</b> OK75A10271 1,60mm FIBER / FIBRE <b>61410906</b> OK75A10271 2,0mm FIBER / FIBRE ø101

▲ : İçerikte Bulunmamaktadır...

▲ : Not included in the set

▲ : Non inclus dans la pochette

00: Motor Takım Keçesiz ve Subap Lastiksiz







00: Gasket Set Without oil seals Without Valve Stem Seal

01: Motor Takım Keçesiz - Subap Lastikli

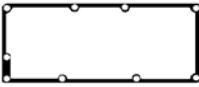
01: Gasket set With Valve Stem Seal Without Oil Seals

02: Motor Full Takım Keçeli ve Subap Lastikli

02: Gasket Full Set With oil seals and Valve Stem Seals

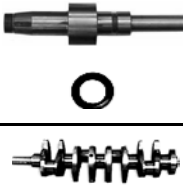
<p>Subap Kapak Valve Cover Gasket Zylinderkopfhaube Couvre-culbut.</p> 	<p>Karter Oil Pan Ölwanne Carter d'huile</p> 	<p>Emme Manifold Intake Manifold Ansaug Admission</p> 	<p>Egzoz Manifold Exhaust Manifold Auspuffkrümmer Collecteur D'echappement</p> 	<p>Eksoz Boğaz Exhaust Pipe Auspuff Kehle</p> 	<p>Supap Keçesi Valve Stem Seal Ventilschaft Queue de soupape</p> 	

■ : Delik - Çentik

■ : Hole - Notch

■ : Trou - Entaille

NOT: Katalogdaki Orijinal Kodlar Referans Amacıyla Kullanılmıştır.Lütfen COTECH Kodlarını Kullanınız.  
Original codes used for reference only.Please use COTECH codes for orders.

KIA

00



Silindir Kapak

Cylinder Head

01



Zylinderkopf

02



Joint de culasse

03



04

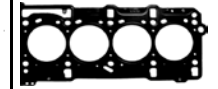

Ltr	MODEL	PS/KW	ENGINE/MOTOR	
3,3 3297	6 CYL ø92 SORENTO I V6 11/07-->	248 PS / 182 KW	G6DB	61510305  22311-3C140 1,50mm FIBER / FIBRE  22311-3C130 1,50mm FIBER / FIBRE ø93,5
3,5 3497	6 CYL ø93 SORENTO V6 11/02--> SEDONA V6 09/03--> OPIRUS V6 AMANTI V6 ( DOCH )	203 PS/ 149 KW	6G74 G6CU	61416005  22311-39501 1,20mm FIBER / FIBRE  22311-39502 1,20mm FIBER / FIBRE ø94

▲ : İçerikte Bulunmamaktadır...

▲ : Not included in the set

▲ : Non inclus dans la pochette

00: Motor Takım Keçesiz ve Subap Lastiksiz







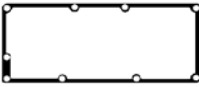

00: Gasket Set Without oil seals Without Valve Stem Seal

01: Motor Takım Keçesiz - Subap Lastikli

01: Gasket set With Valve Stem Seal Without Oil Seals

02: Motor Full Takım Keçeli ve Subap Lastikli

02: Gasket Full Set With oil seals and Valve Stem Seals

<p>Subap Kapak Valve Cover Gasket Zylinderkopfhaube Couvre-culbut.</p> 	<p>Karter Oil Pan Ölwanne Carter d'huile</p> 	<p>Emme Manifold Intake Manifold Ansaug Admission</p> 	<p>Egzoz Manifold Exhaust Manifold Auspuffkrümmer Collecteur D'echappement</p> 	<p>Eksoz Boğaz Exhaust Pipe Auspuff Kehle</p> 	<p>Supap Keçesi Valve Stem Seal Ventilschaft Queue de soupape</p> 	  

■ : Delik - Çentik

■ : Hole - Notch

■ : Trou - Entaille

NOT: Katalogdaki Orjinal Kodlar Referans Amacıyla Kullanılmıştır.Lütfen COTECH Kodlarını Kullanınız.  
Original codes used for reference only.Please use COTECH codes for orders.

00



Silindir Kapak  
Cylinder Head

01



Zylinderkopf

02



Joint de culasse

03



04



Ltr	MODEL	PS/KW	ENGINE/MOTOR		
1,1 1100	4 CYL ø76 FORMAN SAMARA 02/88-->12/94	53 PS / 39 KW 58 PS / 43 KW	BA3 21081	64021000 2900-4705	<p>64021005 2108-1003020 1,50mm ø78</p>
1,2 1198	4 CYL ø76 VAZ 2101 VAZ 2102 01/70-->06/86	60 PS / 44 KW	BA3 2101 OHC	60311002 2101-100001  60311000 2101-100001	<p>60311005 2101-1003020 1,20mm  60311006 2101-1003020 1,80mm ø77,5</p>
1,3 1288	4 CYL ø76 FORMAN SAMARA VAZ 2108 VAZ 2109 VAZ 21086 VAZ 21096 01/86-->12/94	65 PS / 48 KW 61 PS / 45 KW 63 PS / 46 KW	BA3 2108 OHC	64021000 2900-4705	<p>64021005 2108-1003020 1,50mm ø78</p>
1,3 1294	4 CYL ø79 VAZ 21011 VAZ 21033 08/74-->08/84	69 PS / 51 KW	OHC	64016002 42602555  64016000 42602555	<p>64016005 21011-13020 1,20mm  64016006 21011-13020 1,80mm ø82</p>
1,3 1294	4 CYL ø79 VAZ 2105 VAZ 2104 05/81-->	65 PS / 48 KW	BA3 2105	64013002 46602556  64013000 46602556	<p>64013005 1,20mm 2105-1003020  64013006 2105-1003020 1,80mm ø81</p>

▲ : İçerikte Bulunmamaktadır...

▲ : Not included in the set

▲ : Non inclus dans la pochette

00: Motor Takım Keçesiz ve Subap Lastiksiz











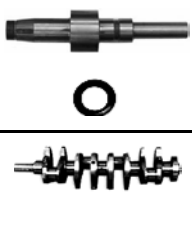
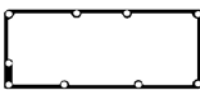





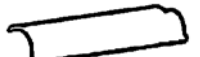



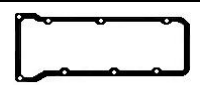
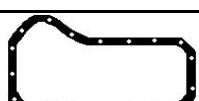



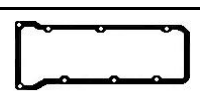
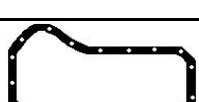

00: Gasket Set Without oil seals Without Valve Stem Seal

01: Motor Takım Keçesiz - Subap Lastikli

01: Gasket set With Valve Stem Seal Without Oil Seals

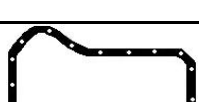
02: Motor Full Takım Keçeli ve Subap Lastikli

02: Gasket Full Set With oil seals and Valve Stem Seals

Subap Kapak Valve Cover Gasket Zylinderkopfhaube Couvre-culbut.	Karter Oil Pan Ölwanne Carter d'huile	Emme Manifold Intake Manifold Ansaug Admission	Egzoz Manifold Exhaust Manifold Auspuffkrümmer Collecteur D'echappement	Eksoz Boğaz Exhaust Pipe Auspuff Kehle	Supap Keçesi Valve Stem Seal Ventilschaft Queue de soupape	
						
 <b>60345025</b> 2108-1003270	 <b>60345013</b> 2108-1009070	 <b>60345020x2</b> 21083-1008081		 <b>60345018</b> 2101-1203020		
 <b>60311034</b> 2101-1003270	 <b>60311013</b> 2101-1009070	 <b>60311020x2</b> 2101-1008081		 <b>60345018</b> 2101-1203020	 <b>60107027x8</b> 2101-1007026 8x10,8/14,2x10	<b>21201017</b> 40x56x7 LD
 <b>60345025</b> 2108-1003270	 <b>60345013</b> 2108-1009070	 <b>60345020x2</b> 21083-1008081		 <b>60345018</b> 2101-1203020		
 <b>60311034</b> 2101-1003270	 <b>60311013</b> 2101-1009070	 <b>60311020x2</b> 2101-1008081		 <b>60345018</b> 2101-1203020	 <b>60107027x8</b> 2101-1007026 8x10,8/14,2x10	<b>21201017</b> 40x56x7 LD
 <b>64013025</b> 2105-1003270	 <b>64013013</b> 2105-1009070	 <b>60311020x2</b> 2101-1008081		 <b>60345018</b> 2101-1203020	 <b>60107027x8</b> 2101-1007026 8x10,8/14,2x10	<b>21201017</b> 40x56x7 LD
						<b>21201066</b> 70x90x10 RD

■ : Delik - Çentik

■ : Hole - Notch

■ : Trou - Entaille

NOT: Katalogdaki Orjinal Kodlar Referans Amacıyla Kullanılmıştır.Lütfen COTECH Kodlarını Kullanınız.  
Original codes used for reference only.Please use COTECH codes for orders.

00



Silindir Kapak  
Cylinder Head  
Zylinderkopf  
Joint de culasse

01



02



03



04

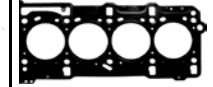

Ltr	MODEL	PS/KW	ENGINE/MOTOR		
1,5 1452	4 CYL ø76 VAZ 2103 11/75-->10/86 VAZ 2107 NIVA 2903	75 PS / 55 KW	OHC	60311002 2101-100001  60311000 2101-100001	 60311005 2101-1003020 1,20mm  60311006 2101-1003020 1,80mm ø77,5
1,5 1452	4 CYL ø79 VAZ 2107 1976-->	75 PS / 55 KW	OHC	64016002 42602555  64016000 42602555	 64016005 21011-13020 1,20mm  64016006 21011-13020 1,80mm ø82
1,5 1499	4 CYL ø82 SAMARA 01/88--> FORMAN VAZ 21083 VAZ 21093 ALEKO SAGONA	75 PS / 55 KW 78 PS / 57 KW 72 PS / 53 KW 71 PS / 52 KW	OHC BA 21083 BA 21093	60345002 2900-4706  60345000 2900-4706	 60345005 21083-1003020 1,50mm  ø84
1,5 1499	4 CYL ø82 110 16 V 01/95--> 111 16 V 10/00--> 112 16 V ( DOCH )	95 PS / 70 KW 91 PS / 67 KW	VAZ 2112	64101000	 64101005 21120-100302000 1,50mm  ø83

▲ : İçerikte Bulunmamaktadır...

▲ : Not included in the set

▲ : Non inclus dans la pochette

00: Motor Takım Keçesiz ve Subap Lastiksiz











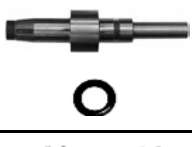
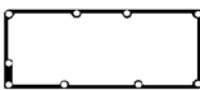





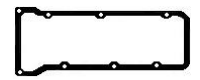



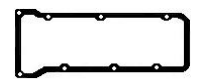

00: Gasket Set Without oil seals Without Valve Stem Seal

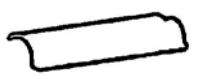
01: Motor Takım Keçesiz - Subap Lastikli

01: Gasket set With Valve Stem Seal Without Oil Seals

02: Motor Full Takım Keçeli ve Subap Lastikli

02: Gasket Full Set With oil seals and Valve Stem Seals

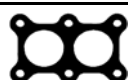
Subap Kapak Valve Cover Gasket Zylinderkopfhaube Couvre-culbut.	Karter Oil Pan Ölwanne Carter d'huile	Emme Manifold Intake Manifold Ansaug Admission	Egzoz Manifold Exhaust Manifold Auspuffkrümmer Collecteur D'echappement	Eksoz Boğaz Exhaust Pipe Auspuff Kehle	Supap Keçesi Valve Stem Seal Ventilschaft Queue de soupape	
						
 <b>60311034</b> 2101-1003270	 <b>60311013</b> 2101-1009070	 <b>60311020x2</b> 2101-1008081		 <b>60345018</b> 2101-1203020	 <b>60107027x8</b> 2101-1007026 8x10,8/14,2x10	<b>21201017</b> 40x56x7 LD
						<b>21201066</b> 70x90x10 RD
 <b>60311034</b> 2101-1003270	 <b>60311013</b> 2101-1009070	 <b>60311020x2</b> 2101-1008081		 <b>60345018</b> 2101-1203020	 <b>60107027x8</b> 2101-1007026 8x10,8/14,2x10	<b>21201017</b> 40x56x7 LD
						<b>21201066</b> 70x90x10 RD
 <b>60345025</b> 2108-1003270	 <b>60345013</b> 2108-1009070	 <b>60345020</b> 21083-1008081		 <b>60345018</b> 2101-1203020	 <b>60107027x8</b> 2101-1007026 8x10,8/14,2x10	<b>21201103x2</b> 28x42x7 RD
						<b>21201071</b> 80x100x10 LD
	 <b>60345013</b> 2108-1009070	 <b>64016018</b>	 <b>64016020</b> 21120-100808900	 <b>64016017</b>		

■ : Delik - Çentik

■ : Hole - Notch

■ : Trou - Entaille

NOT: Katalogdaki Orjinal Kodlar Referans Amacıyla Kullanılmıştır.Lütfen COTECH Kodlarını Kullanınız.  
Original codes used for reference only.Please use COTECH codes for orders.

00



Silindir Kapak

Cylinder Head

01



Zylinderkopf

02









Joint de culasse

03



04



Ltr	MODEL	PS/KW	ENGINE/MOTOR		
1,6 1568	4 CYL ø79 VAZ 2107 NIVA 2121 ALEKO	04/80-->03/95 76 PS / 56 KW 73 PS / 54 KW	BA3	64016002 42602555  64016000 42602555	64016005 21011-13020 1,20mm  64016006 21011-13020 1,80mm ø82
1,9 1905	4 CYL ø83 NIVA 2121 ALEKO	1990--> 65 PS / 47 KW	XUD9(D9A) XUD9	61204002 0197.H5   61204003 0197.H4 	61204009 0209.S5 1,36 mm 1  61204008 0209.S6 1,40 mm 2  61204007 0209.S7 1,44 mm 3  61204006 0209.S8 1,48 mm 4  61204005 0209.S9 1,53 mm 5  ø 84

▲ : İçerikte Bulunmamaktadır...

▲ : Not included in the set

▲ : Non inclus dans la pochette

00: Motor Takım Keçesiz ve Subap Lastiksiz











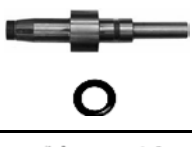
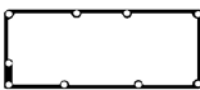





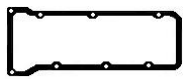
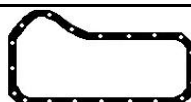

00: Gasket Set Without oil seals Without Valve Stem Seal

01: Motor Takım Keçesiz - Subap Lastikli

01: Gasket set With Valve Stem Seal Without Oil Seals

02: Motor Full Takım Keçeli ve Subap Lastikli

02: Gasket Full Set With oil seals and Valve Stem Seals

Subap Kapak Valve Cover Gasket Zylinderkopfhaube Couvre-culbut.	Karter Oil Pan Ölwanne Carter d'huile	Emme Manifold Intake Manifold Ansaug Admission	Egzoz Manifold Exhaust Manifold Auspuffkrümmer Collecteur D'echappement	Eksoz Boğaz Exhaust Pipe Auspuff Kehle	Supap Keçesi Valve Stem Seal Ventilschaft Queue de soupape	
						
 <b>60311034</b> 2101-1003270	 <b>60311013</b> 2101-1009070	 <b>60311020x2</b> 2101-1008081		 <b>60345018</b> 2101-1203020	 <b>60107027x8</b> 2101-1007026 <b>8x10,8/14,2x10</b>	<b>21201017</b> 40x56x7 LD
 <b>61203525</b> 0249.46 0249.91	 <b>61203013</b> 0304.34  <b>61203014</b> 93501565	 <b>61203116x2</b> 9456044080  <b>61203018x2</b> 91508659	 <b>61205019</b> 1721.01 7810024000  <b>61203120x2</b> 0349.47 93010402		 <b>60107027x8</b> 2101-1007026 <b>8x10,8/14,2x10</b>	<b>21201011x2</b> 35x50x8 WD <b>21201019</b> 42x62x8 RD <b>21201040</b> 90x110x7 LD
		 <b>61203021</b> 0348.JO				



■ : Delik - Çentik

■ : Hole - Notch

■ : Trou - Entaille

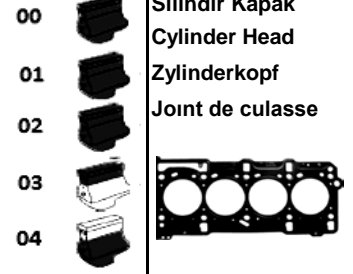
NOT: Katalogdaki Orijinal Kodlar Referans Amacıyla Kullanılmıştır.Lütfen COTECH Kodlarını Kullanınız.  
Original codes used for reference only.Please use COTECH codes for orders.



Ltr	MODEL	PS/KW	ENGINE/MOTOR		
2,3 2286	4 CYL ø90,5 88 90 109 110	09/63-->12/86	69 PS / 51 KW	23L	 <b>61415105</b> 277819 1,20mm <b>61415106</b> 277819 1,80mm ø96
2,5 2495	4 CYL ø90,5 90 110 DEFENDER	09/85-->07/90	84 PS / 62 KW	17H	 <b>61415105</b> 277819 1,20mm <b>61415106</b> 277819 1,80mm ø96

▲ : İçerikte Bulunmamaktadır...

▲ : Not included in the set

▲ : Non inclus dans la pochette

00: Motor Takım Keçesiz ve Subap Lastiksiz







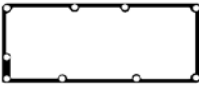

00: Gasket Set Without oil seals Without Valve Stem Seal

01: Motor Takım Keçesiz - Subap Lastikli

01: Gasket set With Valve Stem Seal Without Oil Seals

02: Motor Full Takım Keçeli ve Subap Lastikli

02: Gasket Full Set With oil seals and Valve Stem Seals

<p>Subap Kapak Valve Cover Gasket Zylinderkopfhaube Couvre-culbut.</p> 	<p>Karter Oil Pan Ölwanne Carter d'huile</p> 	<p>Emme Manifold Intake Manifold Ansaug Admission</p> 	<p>Egzoz Manifold Exhaust Manifold Auspuffkrümmer Collecteur D'echappement</p> 	<p>Eksoz Boğaz Exhaust Pipe Auspuff Kehle</p> 	<p>Supap Keçesi Valve Stem Seal Ventilschaft Queue de soupape</p> 	  

■ : Delik - Çentik

■ : Hole - Notch

■ : Trou - Entaille

NOT: Katalogdaki Orijinal Kodlar Referans Amacıyla Kullanılmıştır.Lütfen COTECH Kodlarını Kullanınız.  
Original codes used for reference only.Please use COTECH codes for orders.

00



01



02



03



04



Silindir Kapak  
Cylinder Head  
Zylinderkopf  
Joint de culasse



Ltr	MODEL	PS/KW	ENGINE/MOTOR		
2,1 2112	4 CYL ø90 CLASSIC NC 540 DP NC 649 DP NM 550 DP NM 550 XD NM 750 ST NM 775	62 PS / 45 KW	XDP4.90	61212002 0198.40	 <b>61212005</b> 0203.70 1,60mm  <b>61212006</b> 79 32 566 274 1,80mm  <b>ø94</b>
2,5 2498	4 CYL ø94 BOLERO DELIVERY VAN SINGLE CAB DOUBLE CAB NM 540 XDB NM 550 XDB NM 775 RAKSHAK VOYAGER	72 PS / 53 KW 75 PS / 55 KW	XD3P	61218000 0198.94	 <b>61218005</b> 6 812 074 1,73mm 4  <b>61218006</b> 6 812 073 1,63mm 3  <b>61218006</b> 6 812 072 1,53mm 2  <b>ø96</b>

▲ : İçerikte Bulunmamaktadır...

▲ : Not included in the set

▲ : Non inclus dans la pochette

00: Motor Takım Keçesiz ve Subap Lastiksiz











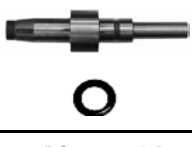
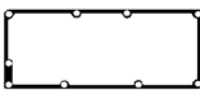





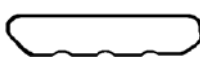



00: Gasket Set Without oil seals Without Valve Stem Seal

01: Motor Takım Keçesiz - Subap Lastikli

01: Gasket set With Valve Stem Seal Without Oil Seals

02: Motor Full Takım Keçeli ve Subap Lastikli

02: Gasket Full Set With oil seals and Valve Stem Seals

Subap Kapak Valve Cover Gasket Zylinderkopfhaube Couvre-culbut.	Karter Oil Pan Ölwanne Carter d'huile	Emme Manifold Intake Manifold Ansaug Admission	Egzoz Manifold Exhaust Manifold Auspuffkrümmer Collecteur D'echappement	Eksoz Boğaz Exhaust Pipe Auspuff Kehle	Supap Keçesi Valve Stem Seal Ventilschaft Queue de soupape	
						
 <b>61212525</b> 1 651 701	 <b>61212014</b> 0313.19  <b>61212015</b> 0304.12	 <b>61212016x3</b> 0348.11	 <b>61212020x2</b> 1 576 449	 <b>61205018</b> 1710.07  <b>61212018</b> 1710.15  <b>61212019</b> 1710.19		<b>21201020</b> 42x60x10 RD
 <b>61212525</b> 1 651 701	 <b>61212014</b> 6 894 122  <b>61212015</b> 0304.12	 <b>61212016x3</b> 0348.11	 <b>61212020x2</b> 0349.10	 <b>61212018</b> 1710.15  <b>61212019</b> 1710.19		

 : Delik - Çentik

 : Hole - Notch

 : Trou - Entaille

NOT: Katalogdaki Orjinal Kodlar Referans Amacıyla Kullanılmıştır.Lütfen COTECH Kodlarını Kullanınız.  
Original codes used for reference only.Please use COTECH codes for orders.

00



Silindir Kapak

Cylinder Head

01



Zylinderkopf

02



Joint de culasse

03



04

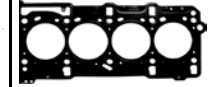

Ltr	MODEL	PS/KW	ENGINE/MOTOR		
1,3 1290	<b>4 CYL ø77</b> <b>323</b> 08/85-->04/90	60 PS / 44 KW	E3		<p><b>61480305</b> E301-10-271 1,40mm</p> <p><b>61480306</b> E301-10-271 2,00mm <b>ø78,5</b></p>
1,3 1323	<b>4 CYL ø71</b> <b>FAMILIA</b> 09/87-->11/90 <b>121</b> <b>323</b>	60 PS / 44 KW 55 PS / 40 KW	B3		<p><b>61410605</b> B302-10-271 1,60mm</p> <p><b>61410606</b> B302-10-271 2,00mm <b>ø74</b></p>
1,4 1399	<b>4 CYL ø74</b> <b>MAZDA 2</b> 04/03-->06/08	68 PS / 50 KW	MZR-CD F6JA F6JB	<p><b>61706002</b> Motor Full Takım Gasket Full Set</p> <p><b>61706003</b> Motor Üst Takım Gasket Head Set</p> <p><b>61706004</b> Motor Alt Takım Conversion Set</p>	<p><b>61706005</b> Y401-10-2H1 1,45mm 5</p> <p><b>61706006</b> Y401-10-274 1,40mm 4</p> <p><b>61706007</b> Y401-10-272 1,30mm 3</p> <p><b>61706008</b> Y401-10-271 1,25mm 2</p> <p><b>61706009</b> Y401-10-273 1,35mm 1</p> <p><b>MLS</b> <b>ø75</b></p>

▲ : İçerikte Bulunmamaktadır...

▲ : Not included in the set

▲ : Non inclus dans la pochette

00: Motor Takım Keçesiz ve Subap Lastiksiz









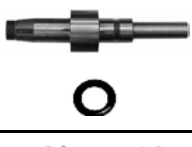
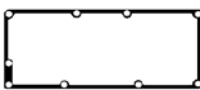

00: Gasket Set Without oil seals Without Valve Stem Seal

01: Motor Takım Keçesiz - Subap Lastikli

01: Gasket set With Valve Stem Seal Without Oil Seals

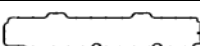
02: Motor Full Takım Keçeli ve Subap Lastikli

02: Gasket Full Set With oil seals and Valve Stem Seals





Subap Kapak Valve Cover Gasket Zylinderkopfhaube Couvre-culbut.	Karter Oil Pan Ölwanne Carter d'huile	Emme Manifold Intake Manifold Ansaug Admission	Egzoz Manifold Exhaust Manifold Auspuffkrümmer Collecteur D'echappement	Eksoz Boğaz Exhaust Pipe Auspuff Kehle	Supap Keçesi Valve Stem Seal Ventilschaft Queue de soupape	
						
						<b>21204017</b> 27x47x7 RD
<b>61706025</b> Y401-10-235	<b>62427465</b>	<b>61706019x4</b> Y401-13-113	<b>61706020</b> Y401-13-460		<b>61706027x8</b> Y401-10-155 5,5x9,5x22,9x17,5	<b>21204018</b> 40x55x6,4 LD
						<b>21204019</b> 85x105x8,8 RD



■ : Delik - Çentik

■ : Hole - Notch

■ : Trou - Entaille

NOT: Katalogdaki Orijinal Kodlar Referans Amacıyla Kullanılmıştır.Lütfen COTECH Kodlarını Kullanınız.  
Original codes used for reference only.Please use COTECH codes for orders.

00		Silindir Kapak Cylinder Head
01		Zylinderkopf
02		Joint de culasse
03		
04		

Ltr	MODEL	PS/KW	ENGINE/MOTOR		
1,5 1490	<b>4 CYL ø77</b> 323 05/85-->05/89 GLC FAMILIA FAMILIA TURBO 323 TURBO	75 PS / 55 KW 88 PS / 65 KW 95 PS / 70 KW 115 PS / 85 KW	E5 E5T		 <b>61480305</b> E301-10-271 1,40mm  <b>61480306</b> E301-10-271 2,00mm ø78,5
1,5 1490	<b>4 CYL ø78</b> 818 1972-->1977	100 PS / 73 KW	NA	<b>61420002</b> 8051-99-100	 <b>61420005</b> R201-10-271F 1,50mm  <b>61420006</b> R201-10-271F 2,00mm ø80

▲ : İçerikte Bulunmamaktadır...

▲ : Not included in the set

▲ : Non inclus dans la pochette

00: Motor Takım Keçesiz ve Subap Lastiksiz











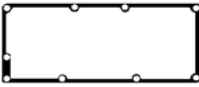

00: Gasket Set Without oil seals Without Valve Stem Seal

01: Motor Takım Keçesiz - Subap Lastikli

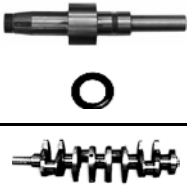
01: Gasket set With Valve Stem Seal Without Oil Seals

02: Motor Full Takım Keçeli ve Subap Lastikli

02: Gasket Full Set With oil seals and Valve Stem Seals

<p>Subap Kapak Valve Cover Gasket Zylinderkopfhaube Couvre-culbut.</p> 	<p>Karter Oil Pan Ölwanne Carter d'huile</p> 	<p>Emme Manifold Intake Manifold Ansaug Admission</p> 	<p>Egzoz Manifold Exhaust Manifold Auspuffkrümmer Collecteur D'echappement</p> 	<p>Eksoz Boğaz Exhaust Pipe Auspuff Kehle</p> 	<p>Supap Keçesi Valve Stem Seal Ventilschaft Queue de soupape</p> 	
 <p><b>61420034</b> 022110235A</p>	 <p><b>61420013</b> 0221-10-431</p>	 <p><b>61420019</b> 038113111A</p>	 <p><b>61420020</b> 0221-13-462</p>	 <p><b>61420017</b> 802B-13-483</p>	<p><b>21201026</b> 48x70x12 RD</p>	
					<p><b>21201205</b> 80x105x13 LD</p>	

■ : Delik - Çentik

■ : Hole - Notch

■ : Trou - Entaille

NOT: Katalogdaki Orjinal Kodlar Referans Amacıyla Kullanılmıştır.Lütfen COTECH Kodlarını Kullanınız.  
Original codes used for reference only.Please use COTECH codes for orders.

00



Silindir Kapak  
Cylinder Head

01



Zylinderkopf

02



Joint de culasse

03



04



Ltr	MODEL	PS/KW	ENGINE/MOTOR		
1,5 1498	<b>4 CYL ø78</b> <b>323 16 V</b> ( DOCH ) 09/98-->01/01	88 PS / 65 KW	ZL		<p><b>61420205</b> ZL01-10-271A 1,20mm FIBER / FIBRE</p> <p><b>61420206</b> ZL01-10-271A 2,00mm FIBER / FIBRE <b>ø79,5</b></p>
1,5 1498	<b>4 CYL ø78</b> <b>MAZDA 2 16V</b> ( DOCH ) 10/07-->	103 PS / 76 KW	ZY-DE ZY-VE		<p><b>61420105</b> ZY01-10-271A 1,20mm FIBER / FIBRE <b>ø79,5</b></p>
1,6 1560	<b>4 CYL ø75</b> <b>MAZDA 3 16V</b> ( DOCH ) 06/04-->06/09	109 PS / 80 KW	Y601	<p><b>61707002</b> Motor Full Takım Gasket Full Set</p> <p><b>61707003</b> Motor Üst Takım Gasket Head Set</p> <p><b>61706004</b> Motor Alt Takım Conversion Set</p>	<p><b>61707005</b> Y601-10-2H1 1,45mm 5 </p> <p><b>61707006</b> Y601-10-274 1,40mm 4 </p> <p><b>61707007</b> Y601-10-272 1,30mm 3 </p> <p><b>61707008</b> Y601-10-271 1,25mm 2 </p> <p><b>61707009</b> Y601-10-273 1,35mm 1  MLS <b>ø76</b></p>

▲ : İçerikte Bulunmamaktadır...

▲ : Not included in the set

▲ : Non inclus dans la pochette

00: Motor Takım Keçesiz ve Subap Lastiksiz











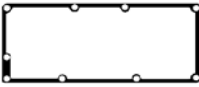

00: Gasket Set Without oil seals Without Valve Stem Seal

01: Motor Takım Keçesiz - Subap Lastikli

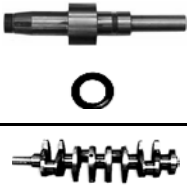
01: Gasket set With Valve Stem Seal Without Oil Seals

02: Motor Full Takım Keçeli ve Subap Lastikli

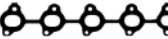
02: Gasket Full Set With oil seals and Valve Stem Seals

<p>Subap Kapak Valve Cover Gasket Zylinderkopfhaube Couvre-culbut.</p> 	<p>Karter Oil Pan Ölwanne Carter d'huile</p> 	<p>Emme Manifold Intake Manifold Ansaug Admission</p> 	<p>Egzoz Manifold Exhaust Manifold Auspuffkrümmer Collecteur D'echappement</p> 	<p>Eksoz Boğaz Exhaust Pipe Auspuff Kehle</p> 	<p>Supap Keçesi Valve Stem Seal Ventilschaft Queue de soupape</p> 	
 <p><b>61707025</b> Y601-10-235</p>	 <p><b>62427465</b></p>	 <p>Y601-10-238 x4</p>  <p>Y601-13-113 x4</p> <p><b>61707018</b></p>	 <p><b>61706021</b> Y401-13-460</p>		 <p><b>61707026x16</b> Y601-10-155 <b>5,5x9,5x18,1x14</b></p>	<p><b>21204017</b> 27x47x7 RD</p> <p><b>21204018</b> 40x55x6,4 LD</p> <p><b>21204019</b> 85x105x8,8 RD</p>

■ : Delik - Çentik

■ : Hole - Notch

■ : Trou - Entaille

NOT: Katalogdaki Orijinal Kodlar Referans Amacıyla Kullanılmıştır.Lütfen COTECH Kodlarını Kullanınız.  
Original codes used for reference only.Please use COTECH codes for orders.

00



Silindir Kapak

Cylinder Head

01



Zylinderkopf

02



Joint de culasse

03



04



Ltr	MODEL	PS/KW	ENGINE/MOTOR		
1,6 1586	<b>4 CYL ø78</b> 616 1970->1978 626 1979->1982 818 1971->1978 B 1600 1971->1975 CAPELLA 1971->1975 PICK-UP 1971->1975	75 PS / 55 KW	NA	61420002 8051-99-100	 <b>61420005</b> R201-10-271F 1,50mm <b>61420006</b> R201-10-271F 2,00mm <b>ø80</b>
1,6 1587	<b>4 CYL ø81</b> CAPELLA 11/82-->09/87 626 ( SOCH )	80 PS / 59 KW	F6		 <b>61420505</b> F501-10-F271 1,80mm <b>ø83,5</b>
1,6 1596	<b>4 CYL ø79</b> MAZDA 2 16V 10/03--> ( DOCH )	101 PS 74 KW	C6 FYJA		 <b>62218205</b> 1 305 949 1,20mm FIBER / FIBRE <b>ø80</b>
1,6 1597	<b>4 CYL ø78</b> PROTEGE 16V 01/01-->05/04 323 ( DOCH )	98 PS / 72 KW 95 PS / 70 KW	ZM		 <b>61420205</b> ZL01-10-271A 1,20mm FIBER / FIBRE <b>61420206</b> ZL01-10-271A 2,00mm FIBER / FIBRE <b>ø79,5</b>
1,6 1598	<b>4 CYL ø78</b> MAZDA 3 16V 10/03--> ( DOCH )	105 PS / 77 KW	Z6 B6ZE LF		 <b>61420105</b> ZY01-10-271A 1,20mm FIBER / FIBRE <b>ø79,5</b>

▲ : İçerikte Bulunmamaktadır...

▲ : Not included in the set

▲ : Non inclus dans la pochette

00: Motor Takım Keçesiz ve Subap Lastiksiz











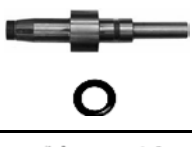
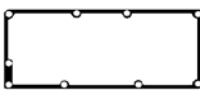

00: Gasket Set Without oil seals Without Valve Stem Seal

01: Motor Takım Keçesiz - Subap Lastikli

01: Gasket set With Valve Stem Seal Without Oil Seals

02: Motor Full Takım Keçeli ve Subap Lastikli

02: Gasket Full Set With oil seals and Valve Stem Seals

Subap Kapak Valve Cover Gasket Zylinderkopfhaube Couvre-culbut.	Karter Oil Pan Ölwanne Carter d'huile	Emme Manifold Intake Manifold Ansaug Admission	Egzoz Manifold Exhaust Manifold Auspuffkrümmer Collecteur D'echappement	Eksoz Boğaz Exhaust Pipe Auspuff Kehle	Supap Keçesi Valve Stem Seal Ventilschaft Queue de soupape	
						
						21201026 48x70x12 RD
61420034 022110235A	61420013 0221-10-431	61420019 038113111A	61420020 0221-13-462	61420017 802B-13-483		21201205 80x105x13 LD

■ : Delik - Çentik

■ : Hole - Notch

■ : Trou - Entaille

NOT: Katalogdaki Orjinal Kodlar Referans Amacıyla Kullanılmıştır.Lütfen COTECH Kodlarını Kullanınız.  
Original codes used for reference only.Please use COTECH codes for orders.

00



Silindir Kapak

Cylinder Head

01



Zylinderkopf

02



Joint de culasse

03



04

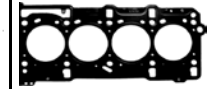

Ltr	MODEL	PS/KW	ENGINE/MOTOR		
1,6 1598	4 CYL ø78 323 ( SOCH ) 09/89-->10/94	84 PS / 62 KW 88 PS / 65 KW	B6		 <b>61480205</b> 0B61L10271A 1,30mm ø79,5
1,8 1789	4 CYL ø86 CAPELLA 626 929 ( SOCH ) 08/87-->	90 PS / 66 KW	F8		 <b>61420305</b> F202-10-271 1,40mm <b>61420306</b> F202-10-271 1,80mm ø87,5
2,0 1998	4 CYL ø86 626 12V 929 12V CAPELLA E 2000 ( SOCH ) 03/83-->05/03	120 PS / 88 KW 82 PS / 60 KW	FE FA FEV4 FE18 FE58 FE60 FE61		 <b>61420305</b> F202-10-271 1,40mm <b>61420306</b> F202-10-271 1,80mm ø87,5
2,0 1998	4 CYL ø86 626 16V CAPELLA 16V ( DOCH ) 06/87-->05/92	148 PS / 109 KW 140 PS / 103 KW	FE		 <b>61410305</b> OK013 10 271 1,20mm FIBER / FIBRE ø87,5
2,0 1998	4 CYL ø86 E 2000 626 CAPELLA 10/92-->04/97 01/83-->02/88	75 PS / 55 KW 63 PS / 46 KW	RF	<b>61410000</b> RF01-99-100	 <b>61410005</b> R201-10-271A ø87,5
2,0 1999	4 CYL ø87,5 MAZDA 6 16V MAZDA 3 16V ( DOCH ) 06/02-->02/05	141 PS / 104 KW 150 PS / 110 KW	LF17 LF18		 <b>61420405</b> 1 229 872 1,20mm FIBER / FIBRE ø89

▲ : İçerikte Bulunmamaktadır...

▲ : Not included in the set

▲ : Non inclus dans la pochette

00: Motor Takım Keçesiz ve Subap Lastiksiz









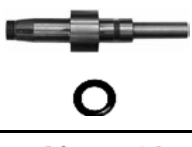
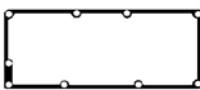

00: Gasket Set Without oil seals Without Valve Stem Seal

01: Motor Takım Keçesiz - Subap Lastikli

01: Gasket set With Valve Stem Seal Without Oil Seals

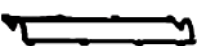
02: Motor Full Takım Keçeli ve Subap Lastikli

02: Gasket Full Set With oil seals and Valve Stem Seals

Subap Kapak Valve Cover Gasket Zylinderkopfhaube Couvre-culbut.	Karter Oil Pan Ölwanne Carter d'huile	Emme Manifold Intake Manifold Ansaug Admission	Egzoz Manifold Exhaust Manifold Auspuffkrümmer Collecteur D'echappement	Eksoz Boğaz Exhaust Pipe Auspuff Kehle	Supap Keçesi Valve Stem Seal Ventilschaft Queue de soupape	
						
						
61410025 RF01-10-235	61410013 F80110-431	61410019 RF0113-111	61410020 RF01-13-462			

■ : Delik - Çentik

■ : Hole - Notch

■ : Trou - Entaille

NOT: Katalogdaki Orijinal Kodlar Referans Amacıyla Kullanılmıştır.Lütfen COTECH Kodlarını Kullanınız.  
Original codes used for reference only.Please use COTECH codes for orders.

00



Silindir Kapak

Cylinder Head

01



Zylinderkopf

02



Joint de culasse

03



04

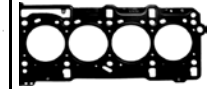

Ltr	MODEL	PS/KW	ENGINE/MOTOR		
2,2 2184	<b>4 CYL ø86</b> 929 11/87-->11/96 B 2200 626 TURBO 12V MX-6 TURBO 12V BT-50  929 12V 626 12V ( SOCH )	115 PS / 85 KW	F2 F2L		 <b>61420305</b> F202-10-271 1,40mm  <b>61420306</b> F202-10-271 1,80mm <b>ø87,5</b>
2,2 2184	<b>4 CYL ø86</b> E 2200 01/84-->05/03 B 2200	71 PS / 52 KW 63 PS / 46 KW	R2 R203 R207 R281 R290	<b>61410000</b> RF01-99-100	 <b>61410005</b> R201-10-271A FIBER / FIBRE <b>ø87,5</b>
2,2 2209	<b>4 CYL ø89</b> B 2200 1979-->1981 LUCE	63 PS / 46 KW	S2		 <b>61480005</b> 0527-10-271A <b>ø97</b>
2,2 2261	<b>4 CYL ø87,5</b> MAZDA 6 16V 07/02-->08/07 MPV 16V TRIBUTE 16V ( DOCH )	150 PS / 110 KW 141 PS / 104 KW 166 PS / 122 KW 162 PS / 119 KW	L3		 <b>61420405</b> 1 229 872 1,20mm FIBER / FIBRE <b>ø89</b>
2,5 2522	<b>4 CYL ø89</b> E 2500 1973-->1977	81 PS / 77 KW	XA	<b>61480000</b> 0527-99-100	 <b>61480005</b> 0527-10-271A <b>ø97</b>
2,7 2701	<b>4 CYL ø89</b> E 2700 1973-->1977	81 PS / 77 KW	XB	<b>61480000</b> 0527-99-100	 <b>61480005</b> 0527-10-271A <b>ø97</b>

▲ : İçerikte Bulunmamaktadır...

▲ : Not included in the set

▲ : Non inclus dans la pochette

00: Motor Takım Keçesiz ve Subap Lastiksiz











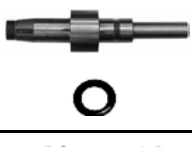
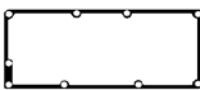



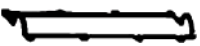

00: Gasket Set Without oil seals Without Valve Stem Seal

01: Motor Takım Keçesiz - Subap Lastikli

01: Gasket set With Valve Stem Seal Without Oil Seals

02: Motor Full Takım Keçeli ve Subap Lastikli

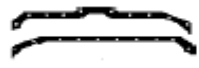
02: Gasket Full Set With oil seals and Valve Stem Seals

Subap Kapak Valve Cover Gasket Zylinderkopfhaube Couvre-culbut.	Karter Oil Pan Ölwanne Carter d'huile	Emme Manifold Intake Manifold Ansaug Admission	Egzoz Manifold Exhaust Manifold Auspuffkrümmer Collecteur D'echappement	Eksoz Boğaz Exhaust Pipe Auspuff Kehle	Supap Keçesi Valve Stem Seal Ventilschaft Queue de soupape	
						
						
<b>61410025</b> RF01-10-235	<b>61410013</b> F80110-431	<b>61410019</b> RF0113-111	<b>61410020</b> RF01-13-462			
						
<b>61480025</b> 1456-10-235	<b>61480013</b> 1363-89-104	<b>61480019x4</b> 0636-13-111	<b>61480021x4</b> 0750-13-461 0750-13-461A			
						
<b>61480025</b> 1456-10-235	<b>61480013</b> 1363-89-104	<b>61480019x4</b> 0636-13-111	<b>61480021x4</b> 0750-13-461 0750-13-461A			





■ : Delik - Çentik

■ : Hole - Notch

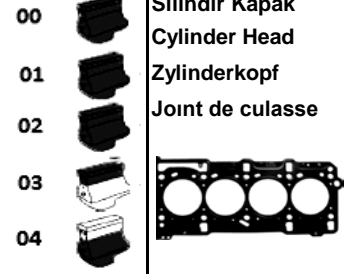
■ : Trou - Entaille

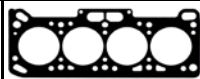
NOT: Katalogdaki Orijinal Kodlar Referans Amacıyla Kullanılmıştır.Lütfen COTECH Kodlarını Kullanınız.  
Original codes used for reference only.Please use COTECH codes for orders.

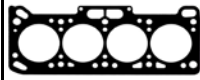

Ltr	MODEL	PS/KW	ENGINE/MOTOR		
1,3 1298	<b>4 CYL ø71</b> COLT 06/86-->05/92 LANCER MIRAGE PROTON SAGA ( SOHC )	70 PS / 51 KW 60 PS / 44 KW	G13B 4G13 4G13B		 <b>61507005</b> MD066163 1,40mm <b>ø72,5</b>
1,3 1298	<b>4 CYL ø71</b> COLT 12V 07/90-->05/94 LANCER 12V MIRAGE 12V LIBERO 12V LIBERO CARGO 12V PROTON PERSONA 12V ( SOHC )	75 PS / 55 KW 60 PS / 44 KW	4G13		 <b>61415405</b> MD323473 1,40mm <b>ø76,5</b>
1,5 1468	<b>4 CYL ø75,5</b> COLT 11/83-->08/89 LANCER ( SOHC ) MIRAGE PRECIS PROTON SAGA	75 PS / 55 KW 70 PS / 50 KW 84 PS / 62 KW	4G15 G15B		 <b>61500305</b> MD016163 1,40mm  <b>61500306</b> MD016163 2,00mm <b>ø76,5</b>
1,5 1468	<b>4 CYL ø75,5</b> COLT 12V 05/89-->08/99 LANCER 12V MIRAGE 12V LIBERO 12V LIBERO CARGO 12V PROTON SAGA 12V PROTON PERSONA 12V ( SOHC )	110 PS / 81 KW 86 PS / 63 KW 90 PS / 66 KW	4G15		 <b>61415405</b> MD323473 1,40mm <b>ø76,5</b>
1,6 1584	<b>4 CYL ø76</b> LANCER 09/03--> SPACE STAR 01/01-->12/04	98 PS / 72 KW	4G18		 <b>61415305</b> MD342397 1,80mm  <b>61415306</b> MD342397 2,00mm FIBER / FIBRE <b>ø77</b>

▲ : İçerikte Bulunmamaktadır...

▲ : Not included in the set

▲ : Non inclus dans la pochette

00: Motor Takım Keçesiz ve Subap Lastiksiz

00: Gasket Set Without oil seals Without Valve Stem Seal







01: Motor Takım Keçesiz - Subap Lastikli

01: Gasket set With Valve Stem Seal Without Oil Seals

02: Motor Full Takım Keçeli ve Subap Lastikli

02: Gasket Full Set With oil seals and Valve Stem Seals



00		Silindir Kapak Cylinder Head
01		Zylinderkopf
02		Joint de culasse
03		
04		

Ltr	MODEL	PS/KW	ENGINE/MOTOR	
2,0	4 CYL ø85			
1997	ETERNA SAPPORO COLT GALANT SIGMA STARION PAJERO SPACE WAGON GALANT TURBO CORDIA PICK-UP TREDIA STARION TURBO EXPO L200 L300 NIMBUS EXPO CHARIOT GRANDIS  (SOCH)	03/85-->04/91  90 PS / 66 KW 84 PS / 62 KW 102 PS / 75 KW	G63B G63B Turbo 4G63 G63BT	  <b>61500905</b> MD040533 1,40mm  <b>61500906</b> MD040533 2,00mm <b>ø86</b>

▲ : İçerikte Bulunmamaktadır...

▲ : Not included in the set

▲ : Non inclus dans la pochette

00: Motor Takım Keçesiz ve Subap Lastiksiz







00: Gasket Set Without oil seals Without Valve Stem Seal

01: Motor Takım Keçesiz - Subap Lastikli

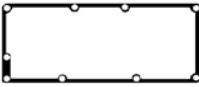
01: Gasket set With Valve Stem Seal Without Oil Seals

02: Motor Full Takım Keçeli ve Subap Lastikli

02: Gasket Full Set With oil seals and Valve Stem Seals

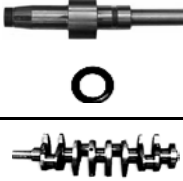
<p>Subap Kapak Valve Cover Gasket Zylinderkopfhaube Couvre-culbut.</p> 	<p>Karter Oil Pan Ölwanne Carter d'huile</p> 	<p>Emme Manifold Intake Manifold Ansaug Admission</p> 	<p>Egzoz Manifold Exhaust Manifold Auspuffkrümmer Collecteur D'echappement</p> 	<p>Eksoz Boğaz Exhaust Pipe Auspuff Kehle</p> 	<p>Supap Keçesi Valve Stem Seal Ventilschaft Queue de soupape</p> 	

■ : Delik - Çentik

■ : Hole - Notch

■ : Trou - Entaille











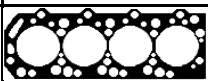

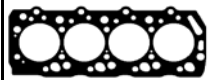
NOT: Katalogdaki Orijinal Kodlar Referans Amacıyla Kullanılmıştır.Lütfen COTECH Kodlarını Kullanınız.  
Original codes used for reference only.Please use COTECH codes for orders.

00  
01  
02  
03  
04

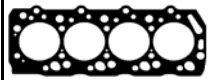

Silindir Kapak  
Cylinder Head  
Zylinderkopf  
Joint de culasse



Ltr	MODEL	PS/KW	ENGINE/MOTOR		
2,3 2346	4 CYL ø91 L200 D 04/83-->10/86 L300D CANTER D MONTERO D PAJERO D SIGMA D SPX D ( SOCH )	68 PS / 50 KW	4D55 4D55T	61450001 MD050092  61450002 MD050092	 61450005 MD050545 1,80mm ø92,5
2,5 2476	4 CYL ø91 L200D 11/86-->10/96 MONTERO D PAJERO D CANTER T35 D DELICA TD L200 TD L300 TD L400 TD SPACE GEAR TD	69 PS / 51 KW 70 PS / 51 KW 87 PS / 64 KW 95 PS / 70 KW	4D56 4D56T	61450001 MD050092 	 61470005 MD302893 1,60mm 5  61470006 22311-42525 1,55mm 4  61470007 22311-42855 1,50mm 3  61470008 22311-42515 1,45mm 2  ø92,5
2,5 2476	4 CYL ø91 L200TD 05/86--> L300D L300TD L400TD PAJERO TD SPACE GEAR TD MONTERO TURBO PAJERO TURBO	133 PS / 98 KW 84 PS / 62 KW 115 PS / 85 KW 99 PS / 73 KW	4D56T	61470002 1000A901 	 61470005 MD302893 1,60mm 5  61470006 22311-42525 1,55mm 4  61470007 22311-42855 1,50mm 3  61470008 22311-42515 1,45mm 2  ø92,5

▲ : İçerikte Bulunmamaktadır...

▲ : Not included in the set

▲ : Non inclus dans la pochette

00: Motor Takım Keçesiz ve Subap Lastiksiz











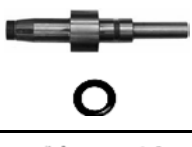
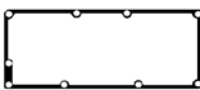





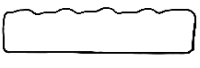

00: Gasket Set Without oil seals Without Valve Stem Seal

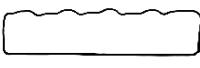
01: Motor Takım Keçesiz - Subap Lastikli

01: Gasket set With Valve Stem Seal Without Oil Seals

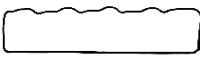
02: Motor Full Takım Keçeli ve Subap Lastikli

02: Gasket Full Set With oil seals and Valve Stem Seals

Subap Kapak Valve Cover Gasket Zylinderkopfhaube Couvre-culbut.	Karter Oil Pan Ölwanne Carter d'huile	Emme Manifold Intake Manifold Ansaug Admission	Egzoz Manifold Exhaust Manifold Auspuffkrümmer Collecteur D'echappement	Eksoz Boğaz Exhaust Pipe Auspuff Kehle	Supap Keçesi Valve Stem Seal Ventilschaft Queue de soupape	
						
 <b>61450025</b> MD050312	 <b>61450013</b> MD149392	 <b>61450021</b> MD050482			 <b>61450026x8</b> 8x13x9x13	<b>21201013</b> 35x50x8 RD <b>21201023</b> 44x60x7 RD <b>21201035</b> 80x96x9 LD <b>21201004</b> 25x35x6 <b>21201001</b> 17x28x7
 <b>61450025</b> MD050312	 <b>61450013</b> MD149392	 <b>61450021</b> MD050482			 <b>61450026x8</b> 8x13x9x13	<b>21201013</b> 35x50x8 RD <b>21201023</b> 44x60x7 RD <b>21201035</b> 80x96x9 LD <b>21201004</b> 25x35x6 <b>21201001</b> 17x28x7
 <b>61450025</b> MD050312	 <b>61450013</b> MD149392	 <b>61470021</b> 28520-42070			 <b>61450026x8</b> 8x13x9x13	<b>21201013</b> 35x50x8 RD <b>21201023</b> 44x60x7 RD <b>21201035</b> 80x96x9 LD <b>21201004</b> 25x35x6 <b>21201001</b> 17x28x7

■ : Delik - Çentik

■ : Hole - Notch

■ : Trou - Entaille

NOT: Katalogdaki Orijinal Kodlar Referans Amacıyla Kullanılmıştır.Lütfen COTECH Kodlarını Kullanınız.  
Original codes used for reference only.Please use COTECH codes for orders.

00



Silindir Kapak  
Cylinder Head

01



Zylinderkopf

02



Joint de culasse

03



04



Ltr	MODEL	PS/KW	ENGINE/MOTOR		
1,0 988	4 CYL ø73 SUNNY CHERRY 09/70-->09/78	45 PS / 33 KW	A10		 <b>61412005</b> 11044-H3901 1,60mm ø76
1,2 1149	4 CYL ø69 KUBISTAR 04/06-->	75 PS / 55 KW	D4F 712	<b>40108603</b> 77 01 473 003	 <b>60108605</b> 8200062273 MLS ø70
1,2 1171	4 CYL ø73 SUNNY CHERRY 07/78-->08/81	52 PS / 38 KW	A12		 <b>61412005</b> 11044-H3901 1,60mm ø76
1,3 1270	4 CYL ø76 SUNNY PULSAR LANGREY 08/81-->10/86	60 PS / 44 KW	E13S		 <b>61412105</b> 11044-01M10 1,20mm ø77,5
1,4 1397	4 CYL ø76 CHERRY SUNNY B 310 08/80-->07/81	80 PS / 59 KW	A14S		 <b>61412205</b> 11044-H7200 1,20mm ø77,5
1,4 1397	4 CYL ø73 SUNNY 06/79-->02/82	65 PS / 48 KW 67 PS / 49 KW	A14		 <b>61412005</b> 11044-H3901 1,60mm ø76

▲ : İçerikte Bulunmamaktadır...

▲ : Not included in the set

▲ : Non inclus dans la pochette

00: Motor Takım Keçesiz ve Subap Lastiksiz











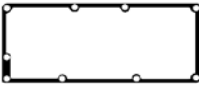

00: Gasket Set Without oil seals Without Valve Stem Seal

01: Motor Takım Keçesiz - Subap Lastikli

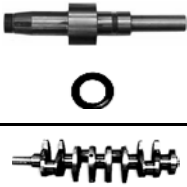
01: Gasket set With Valve Stem Seal Without Oil Seals

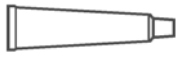
02: Motor Full Takım Keçeli ve Subap Lastikli

02: Gasket Full Set With oil seals and Valve Stem Seals

<p>Subap Kapak Valve Cover Gasket Zylinderkopfhaube Couvre-culbut.</p> 	<p>Karter Oil Pan Ölwanne Carter d'huile</p> 	<p>Emme Manifold Intake Manifold Ansaug Admission</p> 	<p>Egzoz Manifold Exhaust Manifold Auspuffkrümmer Collecteur D'echappement</p> 	<p>Eksoz Boğaz Exhaust Pipe Auspuff Kehle</p> 	<p>Supap Keçesi Valve Stem Seal Ventilschaft Queue de soupape</p> 	
 <p><b>60108625</b> 77 01 049 888</p>	 <p><b>62427465</b></p>	 <p><b>60108618</b> 77 01 473 007</p>	 <p><b>60108621</b> 77 00 115 971</p>		 <p><b>60108626x16</b> 5,5x11x23x15,7</p>	<p><b>21204701</b> 28x47x8 RD</p>

■ : Delik - Çentik

■ : Hole - Notch

■ : Trou - Entaille

NOT: Katalogdaki Orijinal Kodlar Referans Amacıyla Kullanılmıştır.Lütfen COTECH Kodlarını Kullanınız.  
Original codes used for reference only.Please use COTECH codes for orders.

00



Silindir Kapak

Cylinder Head

01



Zylinderkopf

02



Joint de culasse

03



04

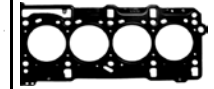

Ltr	MODEL	PS/KW	ENGINE/MOTOR		
1,5 1461	4 CYL ø76 ALMERA DCI 01/03--> KUBISTAR DCI MICRA DCI NOTE DCI	82 PS / 60 KW 65 PS / 48 KW	K9K 700 K9K 704 K9K 722	62457102 Motor Full Takım Gasket Full Set  62457103 77 01 473 371  62457104 Motor Alt Takım Conversion Set	 <b>62457105</b> 82 00 071 111 0,60mm  <b>62457106</b> 82 00 071 111 0,82mm <b>MLS</b> <b>ø77,5</b>
1,5 1483	4 CYL ø78 PICK-UP CABSTAR HOMY TRUCK HOMER	78 PS / 57 KW	J15		 <b>61412305</b> 11044-A3800 1,80mm <b>ø80</b>
1,5 1487	4 CYL ø76 SUNNY 03/82-->08/90 PULSAR LANGREY SENTRA	75 PS / 55 KW	E15S/E		 <b>61412105</b> 11044-01M10 1,20mm <b>ø77,5</b>
1,5 1487	4 CYL ø76 VANETTE 07/81-->12/95 SUNNY B 310	82 PS / 60 KW	A15S		 <b>61412205</b> 11044-H7200 1,20mm <b>ø77,5</b>
1,5 1487	4 CYL ø76 TSURU 1984-->1994 SAMURAI SEDAN NINJA GAYIN (SOCH ) ( Mexico )	75 PS / 55 KW	E15		 <b>61412105</b> 11044-01M10 1,20mm <b>ø77,5</b>
1,5 1487	4 CYL ø76 FORKLIFT 1985-->	82 PS / 60 KW	A15		 <b>61412205</b> 11044-H7200 1,20mm <b>ø77,5</b>

▲ : İçerikte Bulunmamaktadır...

▲ : Not included in the set

▲ : Non inclus dans la pochette

00: Motor Takım Keçesiz ve Subap Lastiksiz









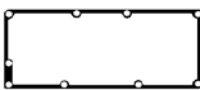

00: Gasket Set Without oil seals Without Valve Stem Seal

01: Motor Takım Keçesiz - Subap Lastikli

01: Gasket set With Valve Stem Seal Without Oil Seals

02: Motor Full Takım Keçeli ve Subap Lastikli

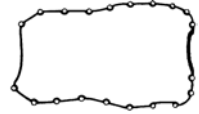
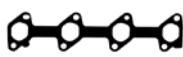
02: Gasket Full Set With oil seals and Valve Stem Seals

Subap Kapak Valve Cover Gasket Zylinderkopfhaube Couvre-culbut.	Karter Oil Pan Ölwanne Carter d'huile	Emme Manifold Intake Manifold Ansaug Admission	Egzoz Manifold Exhaust Manifold Auspuffkrümmer Collecteur D'echappement	Eksoz Boğaz Exhaust Pipe Auspuff Kehle	Supap Keçesi Valve Stem Seal Ventilschaft Queue de soupape	
						
						<b>21204024</b> 28x42x5 RD
<b>62457125</b> 13270-00Q0B	<b>62457165</b> 77 00 273 486		<b>62457121</b> 14036-BN700		<b>62457144x8</b> 77 00 109 840 <b>6x8,8x12,2x9,7</b>	<b>21204025</b> 35x47x7 RD
						<b>21204033</b> 80x100x9 LD

■ : Delik - Çentik

■ : Hole - Notch

■ : Trou - Entaille

NOT: Katalogdaki Orijinal Kodlar Referans Amacıyla Kullanılmıştır.Lütfen COTECH Kodlarını Kullanınız.  
Original codes used for reference only.Please use COTECH codes for orders.

00



Silindir Kapak

Cylinder Head

01



Zylinderkopf

02



Joint de culasse

03



04

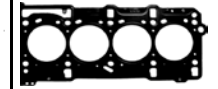

Ltr	MODEL	PS/KW	ENGINE/MOTOR		
1,6 1567	<b>4 CYL ø78</b> GUAYIN SEDAN PICK-UP ( Mexico ) 1970-->1985	78 PS / 57 KW	J16		 <b>61412305</b> 11044-A3800 1,80mm ø80
1,6 1567	<b>4 CYL ø78</b> CABSTAR CARAVAN HOMER TRUCK 1970-->1978	80 PS / 60 KW	J16		 <b>61412305</b> 11044-A3800 1,80mm ø80
1,6 1597	<b>4 CYL ø76</b> TSURU SAMURAI SEDAN NINJA GAYIN ( SOCH ) ( Mexico ) 1984-->1994	75 PS / 55 KW	E16		 <b>61412105</b> 11044-01M10 1,20mm ø77,5
1,6 1598	<b>4 CYL ø79,5</b> KUBISTAR 16V 08/03-->	95 PS / 70 KW	K4M 752	<b>62457202</b> Motor Full Takım Gasket Full Set  <b>62457203</b> 77 01 471 886	 <b>62457205</b> 77 00 112 739 MLS ø80,5

▲ : İçerikte Bulunmamaktadır...

▲ : Not included in the set

▲ : Non inclus dans la pochette

00: Motor Takım Keçesiz ve Subap Lastiksiz









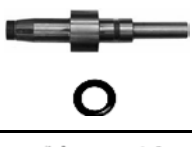
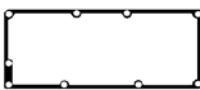

00: Gasket Set Without oil seals Without Valve Stem Seal

01: Motor Takım Keçesiz - Subap Lastikli

01: Gasket set With Valve Stem Seal Without Oil Seals

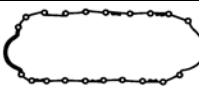
02: Motor Full Takım Keçeli ve Subap Lastikli

02: Gasket Full Set With oil seals and Valve Stem Seals

Subap Kapak Valve Cover Gasket Zylinderkopfhaube Couvre-culbut.	Karter Oil Pan Ölwanne Carter d'huile	Emme Manifold Intake Manifold Ansaug Admission	Egzoz Manifold Exhaust Manifold Auspuffkrümmer Collecteur D'echappement	Eksoz Boğaz Exhaust Pipe Auspuff Kehle	Supap Keçesi Valve Stem Seal Ventilschaft Queue de soupape	
						
						<b>21204024x2</b> 28x42x5 RD
	<b>62457265</b> 77 00 103 687	<b>62457219</b> 77 00 105 852	<b>62457221</b> 77 00 107 181		<b>62457244x16</b> 77 00 103 938 <b>5,5x11x28x16,4</b>	<b>21204005</b> 35x47x7 RD
						<b>21204009</b> 80x100x8 LD

■ : Delik - Çentik

■ : Hole - Notch

■ : Trou - Entaille

NOT: Katalogdaki Orijinal Kodlar Referans Amacıyla Kullanılmıştır.Lütfen COTECH Kodlarını Kullanınız.  
Original codes used for reference only.Please use COTECH codes for orders.

00



Silindir Kapak

Cylinder Head

01



Zylinderkopf

02











Joint de culasse

03



04



Ltr	MODEL	PS/KW	ENGINE/MOTOR		
1,3 1248	4 CYL ø69,6 AGILA CDTI 06/03--> COMBO TD COMBO CDTI CORSA C CDTI CORSA C DTI CORSA D CDTI MERIVA CDTI TIGRA CDTI ASTRA H CDTI 04/05--> CORSA D CDTI	75 PS / 55 KW 69 PS / 51 KW  90 PS / 66 KW	D 13 A Y 13 DT Z 13 DT Z 13 DTJ  Z 13 DTH	62427402 Motor Full Takım Gasket Full Set   62427403 16 06 458 16 06 455  62427404 16 06 456 16 06 454 	 62427505 56 07 639 0,72mm  62427506 56 07 640 0,82mm 1   62427507 56 07 641 0,92mm 2  MLS ø70,5
1,3 1297	4 CYL ø75 CORSA A 08/79-->03/93 KADETT D KADETT E ASCONA B 03/79-->08/91 ASCONA C KADETT D KADETT E MANTA B CORSA A 09/84-->08/91 KADETT E ASCONA B 03/75-->03/93 ASCONA C CORSA A KADETT D KADETT E MANTA B	60 PS / 44 KW 60 PS / 44 KW 60 PS / 44 KW 75 PS / 55 KW 57 PS / 42 KW	C 13 N  13 N  13 NB  13 S 13 SB		 62447905 607990 ø76,5

▲ : İçerikte Bulunmamaktadır...

▲ : Not included in the set

▲ : Non inclus dans la pochette

00: Motor Takım Keçesiz ve Subap Lastiksiz







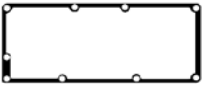

00: Gasket Set Without oil seals Without Valve Stem Seal

01: Motor Takım Keçesiz - Subap Lastikli

01: Gasket set With Valve Stem Seal Without Oil Seals

02: Motor Full Takım Keçeli ve Subap Lastikli

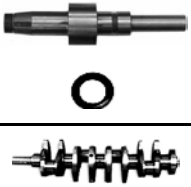
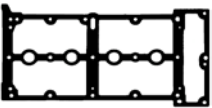
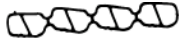
02: Gasket Full Set With oil seals and Valve Stem Seals

<p>Subap Kapak Valve Cover Gasket Zylinderkopfhaube Couvre-culbut.</p> 	<p>Karter Oil Pan Ölwanne Carter d'huile</p> 	<p>Emme Manifold Intake Manifold Ansaug Admission</p> 	<p>Egzoz Manifold Exhaust Manifold Auspuffkrümmer Collecteur D'echappement</p> 	<p>Eksoz Boğaz Exhaust Pipe Auspuff Kehle</p> 	<p>Supap Keçesi Valve Stem Seal Ventilschaft Queue de soupape</p> 	
 <p><b>62427425</b> 56 07 842</p>		 <p><b>62427417</b> 58 50 674</p>	 <p><b>62427421</b> 849 219</p>		 <p><b>62427426x16</b> 1 547 971 6x8,8x11,7x9,5</p>	<p><b>21204023</b> 40x52x7 RD</p> <p><b>21204034</b> 78x100x9 RD</p>

■ : Delik - Çentik

■ : Hole - Notch

■ : Trou - Entaille

NOT: Katalogdaki Orjinal Kodlar Referans Amacıyla Kullanılmıştır.Lütfen COTECH Kodlarını Kullanınız.  
Original codes used for reference only.Please use COTECH codes for orders.

00



01



02



03



04



Silindir Kapak  
Cylinder Head  
Zylinderkopf  
Joint de culasse



Ltr	MODEL	PS/KW	ENGINE/MOTOR		
1,4 1389	<b>4 CYL ø77,6</b> ASTRA F 09/91-->09/93 CORSA A 09/89-->03/93 KADETT E 07/89-->02/93 VECTRA A 04/88-->06/92 ASTRA F 09/91-->01/05 COMBO 07/94-->10/01 CORSA A 10/89-->03/93 CORSA B 03/93-->09/00 KADETT E 01/90-->07/94 ( OHC )	75 PS / 55 KW 54 PS / 40KW  60 PS / 44 KW	14 NV  C 14 NZ X 14 NZ X 14 SZ	<b>62447202</b> 1606697+1606728  <b>62447203</b> 1606697  <b>62447204</b> 1606728	 <b>62447205</b> 607449 1,80mm <b>ø79,5</b>
1,4 1389	<b>4 CYL ø77,6</b> ASTRA F 03/92-->03/01 COMBO 07/94-->10/01 CORSA A 09/91-->03/93 CORSA B 03/93-->09/00 KADETT E 09/89-->08/91 ( OHC )	82 PS / 90 KW	14 SE C 14 SE	<b>62447102</b> 1606730+ 1606728  <b>62447103</b> 1606730  <b>62447204</b> 1606728	 <b>62447205</b> 607449 1,80mm <b>ø79,5</b>
1,4 1389	<b>4 CYL ø77,6</b> ASTRA F 01/96-->03/01 COMBO 08/99-->10/01 CORSA B 09/94-->09/00 TIGRA 07/94-->12/00 ( DOCH 16V )	90 PS / 66 KW	C 14 SEL X 14 XE	<b>62447802</b> 1606034+1606790  <b>62447803</b> 1606034  <b>62447404</b> 1606790	 <b>62447805</b> 5607410 1,40mm <b>ø79,5</b>
1,4 1389	<b>4 CYL ø77,6</b> ASTRA G 02/98-->01/05 ( DOCH 16V )	90 PS / 66 KW	X 14 XE	<b>62448402</b> 1606381+1606790  <b>62448403</b> 1606381  <b>62447404</b> 1606790	 <b>62447805</b> 5607410 1,40mm <b>ø79,5</b>
1,4 1389	<b>4 CYL ø77,6</b> CORSA C 2000--> ( DOCH 16V )	90 PS / 66 KW	Z 14 XE	<b>62448003</b> 1606097  <b>62448004</b> 1606170	 <b>62448005</b> 607410 MLS <b>ø79,3</b>

▲ : İçerikte Bulunmamaktadır...

▲ : Not included in the set

▲ : Non inclus dans la pochette

00: Motor Takım Keçesiz ve Subap Lastiksiz











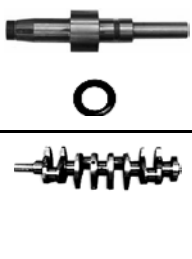
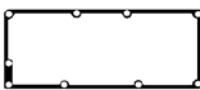











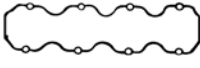

00: Gasket Set Without oil seals Without Valve Stem Seal

01: Motor Takım Keçesiz - Subap Lastikli

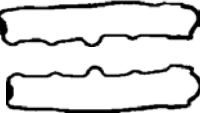
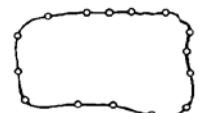
01: Gasket set With Valve Stem Seal Without Oil Seals

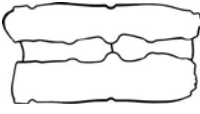
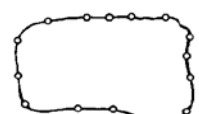
02: Motor Full Takım Keçeli ve Subap Lastikli

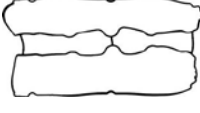
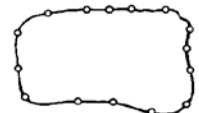
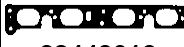
02: Gasket Full Set With oil seals and Valve Stem Seals

Subap Kapak Valve Cover Gasket Zylinderkopfhaube Couvre-culbut.	Karter Oil Pan Ölwanne Carter d'huile	Emme Manifold Intake Manifold Ansaug Admission	Egzoz Manifold Exhaust Manifold Auspuffkrümmer Collecteur D'echappement	Eksoz Boğaz Exhaust Pipe Auspuff Kehle	Supap Keçesi Valve Stem Seal Ventilschaft Queue de soupape	
						
<b>62447235</b> 638 727	<b>62447265</b> 652 577	<b>62447219</b> 850 634	<b>62447221</b> 850 615	<b>62447517</b> 854933	<b>62447227x8</b> 642527 7x11,1/16x10	<b>21201014</b> 35x48x7 RD
						<b>21208013</b> 80x98x10 LD
<b>62447236</b> 638 260 Kauçuk Rubber	<b>62447265</b> 652 577	<b>62447319</b> 850 607	<b>62447221</b> 850 615	<b>62447517</b> 854933	<b>62447227x8</b> 642527 7x11,1/16x10	<b>21208007</b> 26x42x8 RD
						<b>21201014</b> 35x48x7 RD
<b>62447435</b> 638736+638737	<b>62447465</b> 652669	<b>62447419</b> 850668 	<b>62447421</b> 5850613		<b>62447426x16</b> 642533 6x8.8x12.2x9.7	<b>21208013</b> 80x98x10 LD
		<b>62447818</b> 5850615				<b>21208007</b> 26x42x8 RD
		<b>62448019</b> 849196 	<b>62447421</b> 5850613		<b>62447426x16</b> 642533 6x8.8x12.2x9.7	<b>21201014x2</b> 35x48x7 RD
<b>62448025</b> 638742	<b>62447465</b> 652669	<b>62448018</b> 5850624				<b>21208013</b> 80x98x10 LD
		<b>62448019</b> 849196 	<b>62448021</b> 850510		<b>62447426x16</b> 642533 6x8.8x12.2x9.7	<b>21208007</b> 26x42x8 RD
<b>62448025</b> 638742	<b>62447465</b> 652669	<b>62448018</b> 5850624				<b>21201014x2</b> 35x48x7 RD
						<b>21208013</b> 80x98x10 LD
						<b>21208007</b> 26x42x8 RD

■ : Delik - Çentik

■ : Hole - Notch

■ : Trou - Entaille

NOT: Katalogdaki Orijinal Kodlar Referans Amacıyla Kullanılmıştır.Lütfen Oto Conta Kodlarını Kullanınız.  
Original codes used for reference only.Please use OTO CONTA codes for orders.

00



01



02



03



04



Silindir Kapak  
Cylinder Head  
Zylinderkopf  
Joint de culasse



Ltr	MODEL	PS/KW	ENGINE/MOTOR		
1,6 1598	4 CYL ø79 CORSA B 01/94-->12/00 TIGRA CORSA B 03/93-->09/00 ( DOCH 16V)	106 PS / 78 KW 100 PS / 74 KW 109 PS / 80 KW	C 16 SEL X 16 XE C 16 XE	62447402 1606820+1606790  62447403 1606820  62447404 1606790	  62447405 607491 1,40mm ø80,5
1,6 1598	4 CYL ø79 ASCONA C 09/84-->05/93 CORSA A KADETT E VECTRA A ASTRA F 02/93-->02/98 VECTRA A ASTRA F 09/91--> ASTRA G VECTRA B ( OHC )	102 PS / 75 KW 82 PS / 60 KW  71 PS / 52 KW  75 PS / 55 KW	E 16 SE 16SV  X 16 SZ  X 16 SZR 16 NZR	62447302 1606689+1606686  62447303 1606689-1606673  62447204 1606686	  62447305 5607408-607988 1,40mm ø80,5
1,6 1598	4 CYL ø79 ASTRA F 01/94-->01/05 VECTRA B ( DOCH 16V)	101 PS / 74 KW 100 PS / 74 KW	X 16 XEL	62447402 1606820+1606790  62447403 1606820-1606819  62447404 1606790	  62447405 607491 1,40mm ø80,5
1,6 1598	4 CYL ø79 ASTRA G 10/95--> VECTRA B ZAFIRA ( DOCH 16V)	101 PS / 74 KW 100 PS / 74 KW	X 16 XEL	62448502 1606380+1606790  62448503 1606380  62447404 1606790	  62447405 607491 1,40mm ø80,5
1,6 1598	4 CYL ø79 VECTRA B 10/95-->07/02 ( DOCH 16V)	101 PS / 74 KW 100 PS / 74 KW	Y 16 XE	62448303 1606130  62447404 1606790	  62448305 607407 ø80 MLS

▲ : İçerikte Bulunmamaktadır...

▲ : Not included in the set

▲ : Non inclus dans la pochette

00: Motor Takım Keçesiz ve Subap Lastiksiz











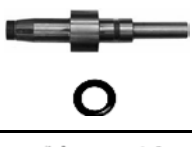
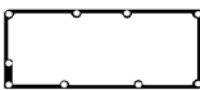





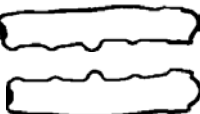











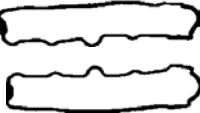
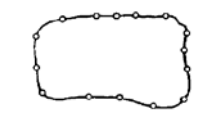

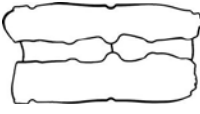

00: Gasket Set Without oil seals Without Valve Stem Seal

01: Motor Takım Keçesiz - Subap Lastikli

01: Gasket set With Valve Stem Seal Without Oil Seals

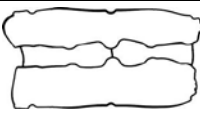
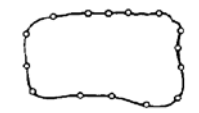
02: Motor Full Takım Keçeli ve Subap Lastikli

02: Gasket Full Set With oil seals and Valve Stem Seals

Subap Kapak Valve Cover Gasket Zylinderkopfhaube Couvre-culbut.	Karter Oil Pan Ölwanne Carter d'huile	Emme Manifold Intake Manifold Ansaug Admission	Egzoz Manifold Exhaust Manifold Auspuffkrümmer Collecteur D'echappement	Eksoz Boğaz Exhaust Pipe Auspuff Kehle	Supap Keçesi Valve Stem Seal Ventilschaft Queue de soupape	
						
 <b>62447435</b> 638736+638737	 <b>62447465</b> 652669	 <b>62447419</b> 850668  <b>62447818</b> 5850615	 <b>62447421</b> 5850613		 <b>62447426x16</b> 642533 6x8.8x12.2x9.7	<b>21201014x2</b> 35x48x7 RD <b>21208013</b> 80x98x10 LD <b>21208007</b> 26x42x8 RD
 <b>62447235</b> 638 727	 <b>62447265</b> 652 577	 <b>62447219</b> 850 634	 <b>62447221</b> 850 615	 <b>62447517</b> 854933	 <b>62447227x8</b> 642527 7x11,1/16x10	<b>21201014</b> 35x48x7 RD <b>21208013</b> 80x98x10 LD <b>21208007</b> 26x42x8 RD
 <b>62447435</b> 638736+638737	 <b>62447465</b> 652669	 <b>62447419</b> 850668  <b>62447818</b> 5850615	 <b>62447421</b> 5850613		 <b>62447426x16</b> 642533 6x8.8x12.2x9.7	<b>21201014x2</b> 35x48x7 RD <b>21208013</b> 80x98x10 LD <b>21208007</b> 26x42x8 RD
 <b>62448025</b> 638742	 <b>62447465</b> 652669	 <b>62448019</b> 849196  <b>62448018</b> 5850624	 <b>62447421</b> 5850613		 <b>62447426x16</b> 642533 6x8.8x12.2x9.7	<b>21201014x2</b> 35x48x7 RD <b>21208013</b> 80x98x10 LD <b>21208007</b> 26x42x8 RD
 <b>62448025</b> 638742	 <b>62447465</b> 652669	 <b>62448019</b> 849196  <b>62448018</b> 5850624	 <b>62448021</b> 850510		 <b>62447426x16</b> 642533 6x8.8x12.2x9.7	<b>21201014x2</b> 35x48x7 RD <b>21208013</b> 80x98x10 LD <b>21208007</b> 26x42x8 RD

■ : Delik - Çentik

■ : Hole - Notch

■ : Trou - Entaille

NOT: Katalogdaki Orjinal Kodlar Referans Amacıyla Kullanılmıştır.Lütfen Oto Conta Kodlarını Kullanınız.  
Original codes used for reference only.Please use OTO CONTA codes for orders.

00



Silindir Kapak

Cylinder Head

01



Zylinderkopf

02



Joint de culasse

03



04



Ltr	MODEL	PS/KW	ENGINE/MOTOR		
1,6 1598	4 CYL ø79 ASTRA H Turbo 09/05--> ASTRA J ASTRA J Turbo ASTRA S T TURBO CORSA D Turbo INSIGNIA Turbo MERIVA Turbo ZAFIRA ZAFIRA Turbo ASTRA H 12/06--> ASTRA J ASTRA S T INSIGNIA ZAFIRA ( DOCH 16V )	211 PS / 155 KW 150 PS / 110 KW  116 PS / 85 KW 115 PS / 85 KW	A 16 LEL A 16 LER A 16 LET A 16 XNT Z 16 LEL Z 16 LER Z 16 LET Z 16 XNT  A 16 XER Z 16 XER		 <b>61417005</b> 71744395 1,20mm FIBER / FIBRE  <b>61417006</b> 71744395 1,80mm FIBER / FIBRE <b>ø82</b>
1,6 1598	4 CYL ø79 ASCONA C 08/86-->09/98 ASTRA F CORSA A KADETT E VECTRA A ( OHC )	75 PS / 55 KW	C 16 NZ E 16 NZ	<b>62447302</b> 1606689+1606686  <b>62447303</b> 1606689  <b>62447204</b> 1606686	 <b>62447305</b> 5607408-607988 1,40mm <b>ø80,5</b>
1,6 1598	4 CYL ø79 ASTRA F 03/91-->02/98 CORSA A 02/92-->03/93 ( OHC )	100 PS / 74 KW 101 PS / 74 KW	C 16 SE C 16 SE	<b>62447002</b> 1606729+1606728  <b>62447003</b> 1606729  <b>62447204</b> 1606686	 <b>62447305</b> 5607408-607988 1,40mm <b>ø80,5</b>
1,6 1598	4 CYL ø79 ASTRA G 02/98-->06/05 ZAFIRA ( DOCH 16V )	101 PS / 74 KW	C 16 SEL	<b>62448502</b> 1606380+1606790  <b>62448503</b> 1606380  <b>62447404</b> 1606790	 <b>62447405</b> 607491 1,40mm <b>ø80,5</b>

▲ : İçerikte Bulunmamaktadır...

▲ : Not included in the set

▲ : Non inclus dans la pochette

00: Motor Takım Keçesiz ve Subap Lastiksiz











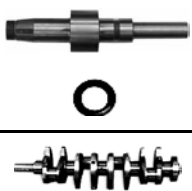
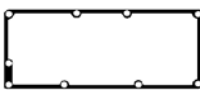







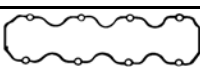

00: Gasket Set Without oil seals Without Valve Stem Seal

01: Motor Takım Keçesiz - Subap Lastikli

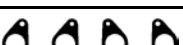
01: Gasket set With Valve Stem Seal Without Oil Seals

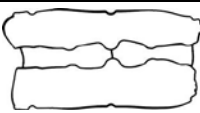
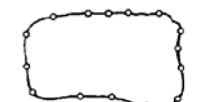
02: Motor Full Takım Keçeli ve Subap Lastikli

02: Gasket Full Set With oil seals and Valve Stem Seals

Subap Kapak Valve Cover Gasket Zylinderkopfhaube Couvre-culbut.	Karter Oil Pan Ölwanne Carter d'huile	Emme Manifold Intake Manifold Ansaug Admission	Egzoz Manifold Exhaust Manifold Auspuffkrümmer Collecteur D'echappement	Eksoz Boğaz Exhaust Pipe Auspuff Kehle	Supap Keçesi Valve Stem Seal Ventilschaft Queue de soupape	
						
 <b>62447235</b> 638 727	 <b>62447265</b> 652 577	 <b>62447219</b> 850 634	 <b>62447221</b> 850 615	 <b>62447517</b> 854933	 <b>62447227x8</b> 642527 7x11,1/16x10	<b>21201014</b> 35x48x7 RD
						<b>21208013</b> 80x98x10 LD
						<b>21208007</b> 26x42x8 RD
 <b>62447236</b> 638 260 Kauçuk Rubber	 <b>62447265</b> 652 577	 <b>62447319</b> 850 607	 <b>62447221</b> 850 615	 <b>62447517</b> 854933	 <b>62447227x8</b> 642527 7x11,1/16x10	<b>21201014</b> 35x48x7 RD
						<b>21208013</b> 80x98x10 LD
						<b>21208007</b> 26x42x8 RD
 <b>62448025</b> 638742	 <b>62447465</b> 652669	 <b>62448019</b> 849196  <b>62448018</b> 5850624	 <b>62447421</b> 5850613		 <b>62447426x16</b> 642533 6x8.8x12.2x9.7	<b>21201014x2</b> 35x48x7 RD
						<b>21208013</b> 80x98x10 LD
						<b>21208007</b> 26x42x8 RD

■ : Delik - Çentik

■ : Hole - Notch

■ : Trou - Entaille

NOT: Katalogdaki Orjinal Kodlar Referans Amacıyla Kullanılmıştır.Lütfen COTECH Kodlarını Kullanınız.  
Original codes used for reference only.Please use COTECH codes for orders.

00



Silindir Kapak

Cylinder Head

01



Zylinderkopf

02



Joint de culasse

03



04



Ltr	MODEL	PS/KW	ENGINE/MOTOR		
1,6 1598	4 CYL ø79 ASTRA G 09/01--> ASTRA G CNG ASTRA H COMBO CNG CORSA C ZAFIRA ZAFIRA CNG ( DOCH 16V )	97 PS / 71 KW 92 PS / 69 KW	Y 16 YNG Z 16 YNG	62448303 1606130	 62448305 607407 ø80 MLS
1,6 1598	4 CYL ø79 ASTRA G 10/95--> MERIVA VECTRA B VECTRA C ZAFIRA ( DOCH 16V )	101 PS / 74 KW 100 PS / 74 KW	Z 16 XE	62448303 1606130 62448004 1606170	 62448305 607407 ø80 MLS
1,8 1796	4 CYL ø79 ASTRA H 01/04--> INSIGNIA SIGNUM VECTRA C ZAFIRA ( DOCH 16V )	140 PS / 103 KW	A 18 XER Z 18 XER		 61417005 71744395 1,20mm FIBER / FIBRE 61417006 71744395 1,80mm FIBER / FIBRE ø82
1,8 1796	4 CYL ø84,8 ASCONA C 08/84-->09/92 KADETT E ASCONA C 01/85-->09/98 ASTRA F KADETT E OMEGA A VECTRA A ( OHC )	100 PS / 74 KW 90 PS / 66 KW 100 PS / 74 KW 82 PS / 60 KW	C 18 NE C 18 NT C 18 NZ E 18 NV E 18 NVR S 18 NV 18 NV 18 SV	62447502 62447503+62447504 62447503 1606682-1606666 62447504 1606663	 62447505 607986 1,40mm ø86,3
1,8 1796	4 CYL ø81,6 VECTRA B 10/95-->09/00 ( DOCH 16V )	116 PS / 85 KW 115 PS / 85 KW	X 18 XE	62448603 1606914	 62448605 608809 1,40mm ø83

▲ : İçerikte Bulunmamaktadır...

▲ : Not included in the set

▲ : Non inclus dans la pochette

00: Motor Takım Keçesiz ve Subap Lastiksiz











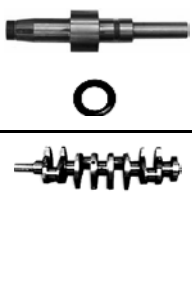
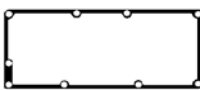





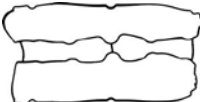





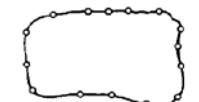



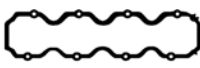

00: Gasket Set Without oil seals Without Valve Stem Seal

01: Motor Takım Keçesiz - Subap Lastikli

01: Gasket set With Valve Stem Seal Without Oil Seals

02: Motor Full Takım Keçeli ve Subap Lastikli

02: Gasket Full Set With oil seals and Valve Stem Seals

Subap Kapak Valve Cover Gasket Zylinderkopfhaube Couvre-culbut.	Karter Oil Pan Ölwanne Carter d'huile	Emme Manifold Intake Manifold Ansaug Admission	Egzoz Manifold Exhaust Manifold Auspuffkrümmer Collecteur D'echappement	Eksoz Boğaz Exhaust Pipe Auspuff Kehle	Supap Keçesi Valve Stem Seal Ventilschaft Queue de soupape	
						
 <b>62448025</b> 638742		 <b>62448019</b> 849196  <b>62448018</b> 5850624	 <b>62448021</b> 850510		 <b>62447426x16</b> 642533 6x8.8x12.2x9.7	<b>21201014x2</b> 35x48x7 RD
 <b>62448025</b> 638742	 <b>62447465</b> 652669	 <b>62448019</b> 849196  <b>62448018</b> 5850624	 <b>62448021</b> 850510		 <b>62447426x16</b> 642533 6x8.8x12.2x9.7	<b>21201014x2</b> 35x48x7 RD <b>21208013</b> 80x98x10 LD <b>21208007</b> 26x42x8 RD
 <b>62447534</b> 638192	 <b>62447564</b> 652587	 <b>62447518</b> 850600  <b>62447719</b> 850601	 <b>62447521</b> 850645	 <b>62447517</b> 854933	 <b>62447227x8</b> 642527 7x11,1/16x10	<b>21201014</b> 35x48x7 RD <b>21208020</b> 31x50x8 RD <b>21208019</b> 90x104x11 LD
 <b>62447625</b> 607647		 <b>62447619</b> 850655	 <b>62447621</b> 850656	 <b>62447517</b> 854933	 <b>62447426x16</b> 642533 6x8.8x12.2x9.7	<b>21201014x2</b> 35x48x7 RD

■ : Delik - Çentik

■ : Hole - Notch

■ : Trou - Entaille

NOT: Katalogdaki Orjinal Kodlar Referans Amacıyla Kullanılmıştır.Lütfen COTECH Kodlarını Kullanınız.  
Original codes used for reference only.Please use COTECH codes for orders.

00



Silindir Kapak

Cylinder Head

01



Zylinderkopf

02



Joint de culasse

03



04



Ltr	MODEL	PS/KW	ENGINE/MOTOR		
1,8 1796	4 CYL ø81,6 ASTRA F 06/93-->03/01 ASTRA F 07/94-->03/01 ( DOCH 16V )	125 PS / 92 KW 115 PS / 85 KW 116 PS / 85 KW	C 18 XE C 18 XEL X 18 XE		 <b>62448605</b> 608809 1,40mm ø83
1,8 1796	4 CYL ø80,5 ASTRA F 02/98-->10/00 ASTRA G 04/02--> VECTRA C ZAFIRA VECTRA B 10/95-->07/03 ASTRA G 09/00--> ASTRA H CORSA C MERIVA SIGNUM TIGRA VECTRA C ZAFIRA ( DOCH 16V )	116 PS / 85 KW 110 PS / 81 KW 125 PS / 92 KW 115 PS / 85 KW 125 PS / 92 KW 122 PS / 90 KW	X 18 XE1 Z 18 XEL X 18 XE1 Z 18 XE Z 18 XE		 <b>62448205</b> 5607858 MLS ø81,5
1,8 1796	4 CYL ø84,8 ASTRA F 09/81-->02/98 OMEGA A 09/86-->03/94 ( OHC )	116 PS / 85 KW 111 PS / 82 KW 115 PS / 85 KW	18 SE 18 SEH	<b>62447502</b> 62447503+62447504 <b>62447503</b> 1606682-1606666 <b>62447504</b> 1606663	 <b>62447505</b> 607986 1,40mm ø86,3
1,9 1870	4 CYL ø80 ARENA D 03/98-->08/01	60 PS / 44 KW	F8Q 600 F8Q 606		 <b>60152005</b> 44 01 561 1,60mm 3 <b>60152006</b> 44 01 518 1,50mm 1 <b>60152007</b> 44 01 560 1,40mm 2 ø81

▲ : İçerikte Bulunmamaktadır...

▲ : Not included in the set

▲ : Non inclus dans la pochette

00: Motor Takım Keçesiz ve Subap Lastiksiz











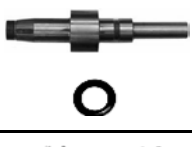
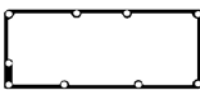

00: Gasket Set Without oil seals Without Valve Stem Seal

01: Motor Takım Keçesiz - Subap Lastikli

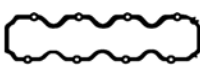
01: Gasket set With Valve Stem Seal Without Oil Seals

02: Motor Full Takım Keçeli ve Subap Lastikli

02: Gasket Full Set With oil seals and Valve Stem Seals

Subap Kapak Valve Cover Gasket Zylinderkopfhaube Couvre-culbut.	Karter Oil Pan Ölwanne Carter d'huile	Emme Manifold Intake Manifold Ansaug Admission	Egzoz Manifold Exhaust Manifold Auspuffkrümmer Collecteur D'echappement	Eksoz Boğaz Exhaust Pipe Auspuff Kehle	Supap Keçesi Valve Stem Seal Ventilschaft Queue de soupape	
						
 <b>62447534</b> 638192	 <b>62447564</b> 652587	 <b>62447518</b> 850600  <b>62447719</b> 850601	 <b>62447521</b> 850645	 <b>62447517</b> 854933	 <b>62447227x8</b> 642527 <b>7x11,1/16x10</b>	<b>21201014</b> 35x48x7 RD <b>21208020</b> 31x50x8 RD <b>21208019</b> 90x104x11 LD

■ : Delik - Çentik

■ : Hole - Notch









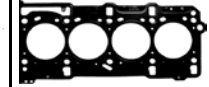



■ : Trou - Entaille

NOT: Katalogdaki Orijinal Kodlar Referans Amacıyla Kullanılmıştır.Lütfen COTECH Kodlarını Kullanınız.  
Original codes used for reference only.Please use COTECH codes for orders.



Silindir Kapak  
Cylinder Head  
Zylinderkopf  
Joint de culasse



Ltr	MODEL	PS/KW	ENGINE/MOTOR		
1,9 1870	4 CYL ø80 MOVANO DTI 09/00-->	82 PS / 60 KW 80 PS / 59 KW	F9Q 770 F9Q 772	<b>60152102</b> Motor Full Takım Gasket Full Set   <b>60152103</b> 44 02 544   <b>60152104</b> 77 01 470 176	  <b>60152105</b> 44 02 582 1,45mm 1   <b>60152106</b> 44 02 581 1,35mm 2   <b>60152107</b> 44 02 583 1,55mm 3  <b>ø81</b>
1,9 1910	4 CYL ø82 ASTRA H CDTI 01/04--> SIGNUM CDTI VECTRA C CDTI ZAFIRA CDTI	120 PS / 88 KW 100 PS / 74 KW	Z 19 DT Z 19 DTL	<b>62427802</b> Motor Full Takım Gasket Full Set   <b>62427803</b> 16 06 329   <b>62427704</b> 16 06 336	  <b>62427805</b> 56 07 843 0,82mm <b>ø83</b>  <b>62427806</b> 56 07 845 0,92mm 1  <b>ø83</b>  <b>62427807</b> 56 07 847 1,02mm 2  <b>MLS</b> <b>ø83</b>
2,0 1998	4 CYL ø86 ASCONA C 09/86-->09/98 ASTRA F CALIBRA A KADETT E OMEGA A VECTRA A ( OHC )	130 PS / 95 KW 99 PS 73 KW	C 20 NE C 20 NEF C 20 NEJ 20 NE 20 SEH 20 SER	<b>62447700</b>  <b>62447702</b> 1606664+1606663  <b>62447703</b> 1606664  <b>62447504</b> 1606663	  <b>62447705</b> 607987 1,30mm  <b>ø87,5</b>

▲ : İçerikte Bulunmamaktadır...

▲ : Not included in the set

▲ : Non inclus dans la pochette

00: Motor Takım Keçesiz ve Subap Lastiksiz











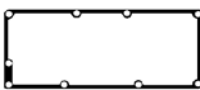





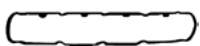

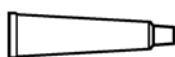

00: Gasket Set Without oil seals Without Valve Stem Seal

01: Motor Takım Keçesiz - Subap Lastikli

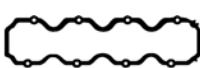
01: Gasket set With Valve Stem Seal Without Oil Seals

02: Motor Full Takım Keçeli ve Subap Lastikli

02: Gasket Full Set With oil seals and Valve Stem Seals

Subap Kapak Valve Cover Gasket Zylinderkopfhaube Couvre-culbut.	Karter Oil Pan Ölwanne Carter d'huile	Emme Manifold Intake Manifold Ansaug Admission	Egzoz Manifold Exhaust Manifold Auspuffkrümmer Collecteur D'echappement	Eksoz Boğaz Exhaust Pipe Auspuff Kehle	Supap Keçesi Valve Stem Seal Ventilschaft Queue de soupape	
						
 <b>60152025</b> 44 08 006	 <b>60152065</b> 44 02 981	 <b>60152121</b> 44 02 641			 <b>60116026x8</b> 44 12 186 <b>7x9,8/13.2x10</b>	<b>21204002</b> 25x42x8 RD
 <b>62427825</b> 56 07 165	 <b>62427465</b>	 <b>62427820</b> 58 50 828	 <b>62427821</b> 58 49 907		 <b>60107027x8</b> 44 01 804 <b>8x10,8/14,2x10</b>	<b>21208003</b> 30x42x7 RD
						<b>21201100</b> 31x41x7 RD
 <b>62447534</b> 638192	 <b>62447564</b> 652587	 <b>62447719</b> 850601	 <b>62447521</b> 850645	 <b>62447517</b> 854933	 <b>62447227x8</b> 642527 <b>7x11,1/16x10</b>	<b>21201014</b> 35x48x7 RD
						<b>21208020</b> 31x50x8 RD
						<b>21208019</b> 90x104x11 LD

■ : Delik - Çentik

■ : Hole - Notch

■ : Trou - Entaille

NOT: Katalogdaki Orijinal Kodlar Referans Amacıyla Kullanılmıştır.Lütfen COTECH Kodlarını Kullanınız.  
Original codes used for reference only.Please use COTECH codes for orders.

00  
01  
02  
03  
04



Silindir Kapak  
Cylinder Head  
Zylinderkopf  
Joint de culasse

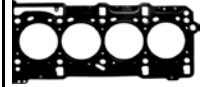

Ltr	MODEL	PS/KW	ENGINE/MOTOR		
2,0 1998	4 CYL ø82,7 VIVARO 08/01--> VIVARO 08/06-->	120 PS 88 KW 117 PS / 86 KW	F4R 720 F4R 820		 <b>62457305</b> 77 00 108 254 MLS ø84
2,0 1998	4 CYL ø86 FRONTERA A 03/92-->10/98 OMEGA B 03/94-->09/99 ( OHC )	115 PS / 85 KW 116 PS / 85 KW	X 20 SE X 20 SE		 <b>62447705</b> 607987 1,30mm ø87,5
2,0 1998	4 CYL ø86 ASTRA G 11/99-->09/02 ( DOCH 16V )	160 PS / 118 KW	X 20 XER	<b>62447603</b> 1606770	 <b>62447605</b> 5607409 1,30mm ø87,5
2,0 1998	4 CYL ø86 ASTRA F 01/94-->01/98 ASTRA G CALIBRA A OMEGA B VECTRA A VECTRA B ( DOCH 16V )	136 PS / 100 KW	X 20 XEV	<b>62447603</b> 1606770	 <b>62447605</b> 5607409 1,30mm ø87,5
2,0 1998	4 CYL ø86 VECTRA B 10/95-->04/02 OMEGA B 03/94-->12/00 ( OHC )	112 PS / 82 KW 115 PS / 85 KW	20 NEJ 20 SE		 <b>62447705</b> 607987 1,30mm ø87,5

▲ : İçerikte Bulunmamaktadır...

▲ : Not included in the set

▲ : Non inclus dans la pochette

00: Motor Takım Keçesiz ve Subap Lastiksiz











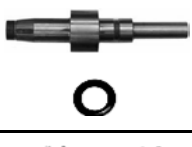
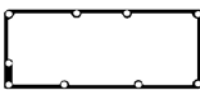



00: Gasket Set Without oil seals Without Valve Stem Seal

01: Motor Takım Keçesiz - Subap Lastikli

01: Gasket set With Valve Stem Seal Without Oil Seals

02: Motor Full Takım Keçeli ve Subap Lastikli

02: Gasket Full Set With oil seals and Valve Stem Seals

Subap Kapak Valve Cover Gasket Zylinderkopfhaube Couvre-culbut.	Karter Oil Pan Ölwanne Carter d'huile	Emme Manifold Intake Manifold Ansaug Admission	Egzoz Manifold Exhaust Manifold Auspuffkrümmer Collecteur D'echappement	Eksoz Boğaz Exhaust Pipe Auspuff Kehle	Supap Keçesi Valve Stem Seal Ventilschaft Queue de soupape	
						
 <b>62447625</b> 607647		 <b>62447619</b> 850655	 <b>62447621</b> 850656		 <b>62447426x16</b> 642533 6x8.8x12.2x9.7	<b>21201014x2</b> 35x48x7 RD
 <b>62447625</b> 607647		 <b>62447619</b> 850655	 <b>62447621</b> 850656		 <b>62447426x16</b> 642533 6x8.8x12.2x9.7	<b>21201014x2</b> 35x48x7 RD

■ : Delik - Çentik

■ : Hole - Notch

■ : Trou - Entaille

NOT: Katalogdaki Orijinal Kodlar Referans Amacıyla Kullanılmıştır.Lütfen COTECH Kodlarını Kullanınız.  
Original codes used for reference only.Please use COTECH codes for orders.

00  
01  
02  
03  
04



Silindir Kapak  
Cylinder Head  
Zylinderkopf  
Joint de culasse

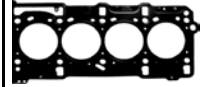

Ltr	MODEL	PS/KW	ENGINE/MOTOR		
2,0 1998	<b>4 CYL ø86</b> <b>OMEGA A</b> ( OHC ) 09/86-->03/94	122 PS / 90 KW	20 SE	<b>62447700</b>  <b>62447702</b> 1606664+1606663  <b>62447703</b> 1606664  <b>62447504</b> 1606663	 <b>62447705</b> 607987 1,30mm <b>ø87,5</b>
2,2 2198	<b>4 CYL ø86</b> <b>VECTRA B</b> ( DOCH 16V ) 09/00-->07/03	147 PS / 108 KW	C 22 SEL	<b>62447603</b> 1606770	 <b>62447605</b> 5607409 1,30mm <b>ø87,5</b>
2,2 2198	<b>4 CYL ø86</b> <b>FRONTERA B</b> 10/98-->  <b>FRONTERA A</b> 03/95-->10/98 <b>SINTRA</b> 11/96-->04/99 <b>OMEGA B</b> 09/99-->07/03 ( DOCH 16V )	136 PS / 100 KW  136 PS / 100 KW 141 PS / 104 KW 144 PS / 104 KW	X 22 SE Y 22 SE X 22 SE X 22 XE Y 22 XE Z 22 XE		 <b>62447605</b> 5607409 1,30mm <b>ø87,5</b>

▲ : İçerikte Bulunmamaktadır...

▲ : Not included in the set

▲ : Non inclus dans la pochette

00: Motor Takım Keçesiz ve Subap Lastiksiz











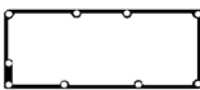



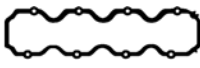

00: Gasket Set Without oil seals Without Valve Stem Seal

01: Motor Takım Keçesiz - Subap Lastikli

01: Gasket set With Valve Stem Seal Without Oil Seals

02: Motor Full Takım Keçeli ve Subap Lastikli

02: Gasket Full Set With oil seals and Valve Stem Seals

Subap Kapak Valve Cover Gasket Zylinderkopfhaube Couvre-culbut.	Karter Oil Pan Ölwanne Carter d'huile	Emme Manifold Intake Manifold Ansaug Admission	Egzoz Manifold Exhaust Manifold Auspuffkrümmer Collecteur D'echappement	Eksoz Boğaz Exhaust Pipe Auspuff Kehle	Supap Keçesi Valve Stem Seal Ventilschaft Queue de soupape	
						
 <b>62447534</b> 638192	 <b>62447564</b> 652587	 <b>62447719</b> 850601	 <b>62447521</b> 850645	 <b>62447517</b> 854933	 <b>62447227x8</b> 642527 7x11,1/16x10	<b>21201014</b> 35x48x7 RD
 <b>62447625</b> 607647		 <b>62447619</b> 850655	 <b>62447621</b> 850656		 <b>62447426x16</b> 642533 6x8.8x12.2x9.7	<b>21208020</b> 31x50x8 RD
						<b>21208019</b> 90x104x11 LD
						<b>21201014x2</b> 35x48x7 RD

■ : Delik - Çentik

■ : Hole - Notch

■ : Trou - Entaille

NOT: Katalogdaki Orijinal Kodlar Referans Amacıyla Kullanılmıştır.Lütfen COTECH Kodlarını Kullanınız.  
Original codes used for reference only.Please use COTECH codes for orders.

00



Silindir Kapak

Cylinder Head

01



Zylinderkopf

02



Joint de culasse

03



04



Ltr	MODEL	PS/KW	ENGINE/MOTOR		
1,0 954	<b>4 CYL ø70</b> 104 205 10/72-->10/83	46 PS / 34 KW 45 PS / 33 KW	XV3 (108) XV5(108)	<b>61216002</b> 198,57	 <b>61216005</b> 0203.84 1,20mm Loc ø16mm <b>61216006</b> 0203.22 1,40mm ø74
1,0 954	<b>4 CYL ø70</b> 106 205 10/87-->	50 PS / 37 KW 45 PS / 33 KW	TU9 TU9M (CDY) TU9M (CDZ)	<b>61221002</b> Motor Full Takım Gasket Full Set <b>61221003</b> 0197.H8+0209.89 <b>61209004</b> 0197.H9	 <b>61221005</b> 0209.89 1,30mm 1 <b>61221006</b> 0209.90 1,50mm 2 ø73,5
1,0 999	<b>4 CYL ø69</b> 206 16V ( DOCH ) 2000-->	75 PS / 55 KW	D4D	<b>60108603</b> 77 01 473 003	 <b>60108605</b> 8200062273 MLS ø70
1,1 1118	<b>4 CYL ø74</b> 309 10/85-->07/89	54 PS / 40 KW	E1		 <b>61208005</b> 0209.H9 1,20mm ø77
1,1 1124	<b>4 CYL ø72</b> PARTNER 106 206 206 SW 05/96-->	60 PS / 44 KW	TU1JP (HFX) TU1JP (HFZ)		 <b>61222005</b> 0209.Y0 1,30mm 1 <b>61222006</b> 0209.Y1 1,50mm 2 ø74

▲ : İçerikte Bulunmamaktadır...

▲ : Not included in the set

▲ : Non inclus dans la pochette

00: Motor Takım Keçesiz ve Subap Lastiksiz











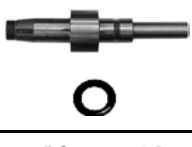
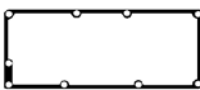





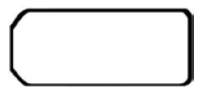



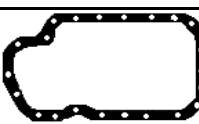

00: Gasket Set Without oil seals Without Valve Stem Seal

01: Motor Takım Keçesiz - Subap Lastikli

01: Gasket set With Valve Stem Seal Without Oil Seals

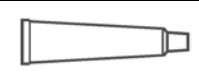
02: Motor Full Takım Keçeli ve Subap Lastikli

02: Gasket Full Set With oil seals and Valve Stem Seals

Subap Kapak Valve Cover Gasket Zylinderkopfhaube Couvre-culbut.	Karter Oil Pan Ölwanne Carter d'huile	Emme Manifold Intake Manifold Ansaug Admission	Egzoz Manifold Exhaust Manifold Auspuffkrümmer Collecteur D'echappement	Eksoz Boğaz Exhaust Pipe Auspuff Kehle	Supap Keçesi Valve Stem Seal Ventilschaft Queue de soupape	
						
 <b>61201525</b> 0249.39	 <b>61201013</b> 0304.46	 <b>61201018</b> 0384.54	 <b>61201020</b> 0349.16	 <b>61205017</b> 7700657683	 <b>60107027x8</b> 956,22 <b>8x10.8/14.2x10</b>	<b>21201013</b> 35x50x8 WD <b>21201033</b> 78x100x10 LD
 <b>61209025</b> 0249.54	 <b>61209013</b> 0304.304	 <b>61209019x2</b>	 <b>61209020x2</b> 0349,A6	 <b>61209017</b> 1709.15	 <b>60116026x8</b> 0956.19 <b>7x9,8/13.2x10</b>	<b>21201062</b> 36x50x7 RD <b>21201021</b> 42x66x6 RD <b>21204504</b> 85x105x8 LD
 <b>60108625</b> 77 01 049 888	 <b>62427465</b>	 <b>60108618</b> 77 01 473 007	 <b>60108621</b> 77 00 115 971		 <b>60108626x16</b> 5,5x11x23x15,7	<b>21204701</b> 28x47x8 RD

■ : Delik - Çentik

■ : Hole - Notch

■ : Trou - Entaille

NOT: Katalogdaki Orijinal Kodlar Referans Amacıyla Kullanılmıştır.Lütfen COTECH Kodlarını Kullanınız.  
Original codes used for reference only.Please use COTECH codes for orders.

00



01



02



03



04



Silindir Kapak  
Cylinder Head  
Zylinderkopf  
Joint de culasse



Ltr	MODEL	PS/KW	ENGINE/MOTOR		
1,1 1124	<b>4 CYL ø72</b> PARTNER 09/96--> 106 306	60 PS / 44 KW	TU1M+ HDY (TU1M) HDZ(TU1M)	<b>61221002</b> Motor Full Takım Gasket Full Set  <b>61221003</b> 0197.H8+0209.89  <b>61209004</b> 0197.H9	 <b>61221005</b> 0209.89 1,30mm 1  <b>61221006</b> 0209.90 1,50mm 2 <b>ø73,5</b>
1,1 1124	<b>4 CYL ø75</b> PARTNER 09/91--> 106 306 205 07/89-->09/98 309	60 PS / 44 KW 54 PS / 40 KW 60 PS / 44 KW	TU1M (HDY) TU1M (HDZ)  TU1M (HDZ)	<b>61209002</b> Motor Full Takım Gasket Full Set  <b>61209003</b> 0197.H8+0209.CJ  <b>61209004</b> 0197.H9	 <b>61209005</b> 0209.CJ 1,30mm 1  <b>61209006</b> 0209.W6 - W7 1,50 mm 2 <b>ø76</b>
1,1 1127	<b>4 CYL ø78</b> 204 09/75-->12/88 304 305	58 PS / 43 KW	XK5	<b>61206002</b> 0197.91	 <b>61206005</b> 0209.G7 1,30mm <b>ø80,5</b>
1,1 1130	<b>4 CYL ø75</b> 204 10/65-->10/77	55 PS / 40 KW 53 PS / 39 KW	XK XK4	<b>61205002</b> 0199.58	 <b>61205005</b> 0199.75 1,20mm <b>ø78</b>
1,2 1204	<b>4 CYL ø74</b> 205 01/87-->12/90	64 PS / 47 KW	F1		 <b>61208005</b> 0209.H9 1,20mm <b>ø77</b>

▲ : İçerikte Bulunmamaktadır...

▲ : Not included in the set

▲ : Non inclus dans la pochette

00: Motor Takım Keçesiz ve Subap Lastiksiz











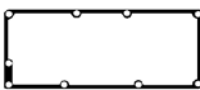











00: Gasket Set Without oil seals Without Valve Stem Seal

01: Motor Takım Keçesiz - Subap Lastikli

01: Gasket set With Valve Stem Seal Without Oil Seals

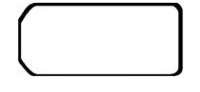
02: Motor Full Takım Keçeli ve Subap Lastikli

02: Gasket Full Set With oil seals and Valve Stem Seals

Subap Kapak Valve Cover Gasket Zylinderkopfhaube Couvre-culbut.	Karter Oil Pan Ölwanne Carter d'huile	Emme Manifold Intake Manifold Ansaug Admission	Egzoz Manifold Exhaust Manifold Auspuffkrümmer Collecteur D'echappement	Eksoz Boğaz Exhaust Pipe Auspuff Kehle	Supap Keçesi Valve Stem Seal Ventilschaft Queue de soupape	
						
<b>61209025</b> 0249.54	<b>61209013</b> 0304.304	<b>61209019x2</b>	<b>61209020x2</b> 0349,A6	<b>61209017</b> 1709.15	<b>60116026x8</b> 0956.19 7x9,8/13.2x10	<b>21201062</b> 36x50x7 RD
						<b>21201021</b> 42x66x6 RD
						<b>21204504</b> 85x105x8 LD
						<b>21201062</b> 36x50x7 RD
<b>61209025</b> 0249.54	<b>61209013</b> 0304.304	<b>61209019x2</b>	<b>61209020x2</b> 0349,A6	<b>61209017</b> 1709.15	<b>60116026x8</b> 0956.19 7x9,8/13.2x10	<b>21201021</b> 42x66x6 RD
						<b>21204504</b> 85x105x8 LD
						<b>21201018</b> 40x49,6x7.3 LD
<b>61205025</b> 0249.21	<b>61205013</b> 0304.09	<b>61205020</b> 0349.23	<b>61205018</b> 1710.11	<b>61205017</b> 1710.09		<b>21201029</b> 60,5x78x9 RD
						<b>21201018</b> 40x49,6x7.3 LD
<b>61205025</b> 0249.21	<b>61205013</b> 0304.09	<b>61205020</b> 0349.23	<b>61205018</b> 1710.11	<b>61205017</b> 1710.09		<b>21201029</b> 60,5x78x9 RD

■ : Delik - Çentik

■ : Hole - Notch

■ : Trou - Entaille

NOT: Katalogdaki Orijinal Kodlar Referans Amacıyla Kullanılmıştır.Lütfen COTECH Kodlarını Kullanınız.  
Original codes used for reference only.Please use COTECH codes for orders.

00



01



02



03



04



Silindir Kapak  
Cylinder Head  
Zylinderkopf  
Joint de culasse



Ltr	MODEL	PS/KW	ENGINE/MOTOR		
1,3 1290	<b>4 CYL ø78</b> 304 09/70-->10/80 305 11/77-->08/86	75 PS / 55 KW 65 PS / 48 KW 60 PS / 44 KW	118(XL5) XL5 XL5S	<b>61206002</b> 0197.91	 <b>61206005</b> 0209.G7 1,30mm ø80,5
1,3 1290	<b>4 CYL ø75</b> 304 10/69-->07/76	75 PS / 55 KW 65 PS / 48 KW	XL3 XL3S	<b>61205002</b> 0199.58	 <b>61205005</b> 0199.75 1,20mm ø78
1,3 1294	<b>4 CYL ø75</b> 205 RALLYE 10/87-->10/90	101 PS / 74 KW	TU24	<b>61209002</b> Motor Full Takım Gasket Full Set  <b>61209003</b> 0197.H8+0209.CJ  <b>61209004</b> 0197.H9	 <b>61209005</b> 0209.CJ 1,30mm 1  <b>61209006</b> 0209.W6 - W7 1,50 mm 2 ø76
1,4 1360	<b>4 CYL ø75</b> 205 02/83-->10/87	60 PS / 44 KW 79 PS / 58 KW 80 PS / 59 KW	150(XY6B) 150B(XY8) 150D(XY7) 150G(XY7) 150H(XY8)	<b>61201002</b> 0197.77	 <b>61201005</b> 0209.A6 1,30mm Loc 14mm ø76
1,4 1360	<b>4 CYL ø75</b> PARTNER 07/88--> 1007 106 205 206 206 SW 306 307	75 PS / 55 KW	KFV (TU3JP) KDX(TU3MC)	<b>61209002</b> Motor Full Takım Gasket Full Set  <b>61209003</b> 0197.H8+0209.CJ  <b>61209004</b> 0197.H9	 <b>61209005</b> 0209.CJ 1,30mm 1  <b>61209006</b> 0209.W6 - W7 1,50 mm 2 ø76

▲ : İçerikte Bulunmamaktadır...

▲ : Not included in the set

▲ : Non inclus dans la pochette

00: Motor Takım Keçesiz ve Subap Lastiksiz

00: Gasket Set Without oil seals Without Valve Stem Seal











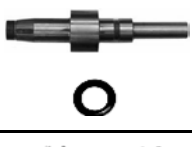
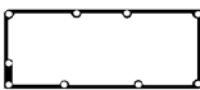





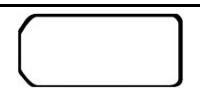



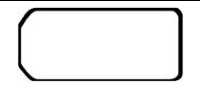











01: Motor Takım Keçesiz - Subap Lastikli

01: Gasket set With Valve Stem Seal Without Oil Seals

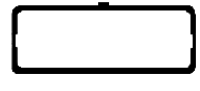
02: Motor Full Takım Keçeli ve Subap Lastikli

02: Gasket Full Set With oil seals and Valve Stem Seals

205

Subap Kapak Valve Cover Gasket Zylinderkopfhaube Couvre-culbut.	Karter Oil Pan Ölwanne Carter d'huile	Emme Manifold Intake Manifold Ansaug Admission	Egzoz Manifold Exhaust Manifold Auspuffkrümmer Collecteur D'échappement	Eksoz Boğaz Exhaust Pipe Auspuff Kehle	Supap Keçesi Valve Stem Seal Ventilschaft Queue de soupape	
						
 <b>61205025</b> 0249.21	 <b>61205013</b> 0304.09	 <b>61205020</b> 0349.23	 <b>61205018</b> 1710.11	 <b>61205017</b> 1710.09		<b>21201018</b> 40x49,6x7.3 LD <b>21201029</b> 60,5x78x9 RD
 <b>61205025</b> 0249.21	 <b>61205013</b> 0304.09	 <b>61205020</b> 0349.23	 <b>61205018</b> 1710.11	 <b>61205017</b> 1710.09		<b>21201018</b> 40x49,6x7.3 LD <b>21201029</b> 60,5x78x9 RD
 <b>61209025</b> 0249.54	 <b>61209013</b> 0304.304	 <b>61209019x2</b>	 <b>61209020x2</b> 0349,A6	 <b>61209017</b> 1709.15	 <b>60116026x8</b> 0956.19 7x9,8/13.2x10	<b>21201062</b> 36x50x7 RD <b>21201021</b> 42x66x6 RD <b>21204504</b> 85x105x8 LD
 <b>61201525</b> 0249.39	 <b>61201013</b> 0304.46	 <b>61201018</b> 0384.54	 <b>61201020</b> 0349.16	 <b>61205017</b> 7700657683	 <b>60107027x8</b> 956,22 8x10.8/14.2x10	<b>21201013</b> 35x50x8 WD <b>21201033</b> 78x100x10 LD
 <b>61209025</b> 0249.54	 <b>61209013</b> 0304.304	 <b>61209019x2</b>	 <b>61209020x2</b> 0349,A6	 <b>61209017</b> 1709.15	 <b>60116026x8</b> 0956.19 7x9,8/13.2x10	<b>21201062</b> 36x50x7 RD <b>21201021</b> 42x66x6 RD <b>21204504</b> 85x105x8 LD

■ : Delik - Çentik

■ : Hole - Notch

■ : Trou - Entaille

NOT: Katalogdaki Orjinal Kodlar Referans Amacıyla Kullanılmıştır.Lütfen COTECH Kodlarını Kullanınız.  
Original codes used for reference only.Please use COTECH codes for orders.

00



01



02



03



04



Silindir Kapak  
Cylinder Head  
Zylinderkopf  
Joint de culasse

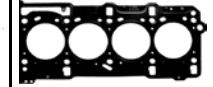

Ltr	MODEL	PS/KW	ENGINE/MOTOR		
1,4 1360	<b>4 CYL ø75</b> PARTNER 01/87--> 106 205 306 309 405	84 PS / 62 KW 60 PS / 44 KW	TU 3 TU3A (K1D) TU3CP (KAY) TU3M (KDY) TU3M (KDZ) TU3MC (KDX) TU3S (K2B) TU3	<b>61209002</b> Motor Full Takım Gasket Full Set  <b>61209003</b> 0197.H8+0209.CJ  <b>61209004</b> 0197.H9	 <b>61209005</b> 0209.CJ 1,30mm 1  <b>61209006</b> 0209.W6 - W7 1,50 mm 2 ø76
1,4 1360	<b>4 CYL ø75</b> 1007 16V 10/03--> 206 SW 16V 206 16V 207 307 SW 16V 307 16V	88 PS / 65 KW	ET3J4 (KFU)		 <b>62190005</b> 0209.CH 0209.FL 1,40mm ø76
1,4 1398	<b>4 CYL ø74</b> 1007 HDI 09/01--> 206 HDI 206 SW HDI 207 HDI 307 HDi 307 HDI	68 PS / 50 KW	DV4TD (8HX) DV4TD (8HZ)	<b>61706002</b> Motor Full Takım Gasket Full Set   <b>61706003</b> Motor Üst Takım Gasket Head Set   <b>61706004</b> Motor Alt Takım Conversion Set	 <b>61706005</b> 0209.AH 1,45mm 5  <b>61706006</b> 0209.AG 1,40mm 4  <b>61706007</b> 0209.AE 1,30mm 3  <b>61706008</b> 0209.AC 1,25mm 2  <b>61706009</b> 0209.AF 1,35mm 1 MLS ø75
1,5 1472	<b>4 CYL ø78</b> 305 11/79-->07/90	88 PS / 65 KW 68 PS / 50 KW	XR5 (142) XR5A (142) XR5S (117)	<b>61206002</b> 0197.91	 <b>61206005</b> 0209.G7 1,30mm ø80,5

▲ : İçerikte Bulunmamaktadır...

▲ : Not included in the set

▲ : Non inclus dans la pochette

00: Motor Takım Keçesiz ve Subap Lastiksiz











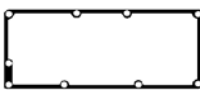









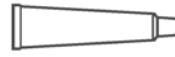

00: Gasket Set Without oil seals Without Valve Stem Seal

01: Motor Takım Keçesiz - Subap Lastikli

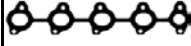
01: Gasket set With Valve Stem Seal Without Oil Seals

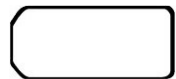
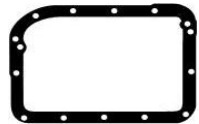
02: Motor Full Takım Keçeli ve Subap Lastikli

02: Gasket Full Set With oil seals and Valve Stem Seals

Subap Kapak Valve Cover Gasket Zylinderkopfhaube Couvre-culbut.	Karter Oil Pan Ölwanne Carter d'huile	Emme Manifold Intake Manifold Ansaug Admission	Egzoz Manifold Exhaust Manifold Auspuffkrümmer Collecteur D'echappement	Eksoz Boğaz Exhaust Pipe Auspuff Kehle	Supap Keçesi Valve Stem Seal Ventilschaft Queue de soupape	
						
						<b>21201062</b> 36x50x7 RD
<b>61209025</b> 0249.54	<b>61209013</b> 0304.304	<b>61209019x2</b>	<b>61209020x2</b> 0349.A6	<b>61209017</b> 1709.15	<b>60116026x8</b> 0956.19 7x9,8/13.2x10	<b>21201021</b> 42x66x6 RD
						<b>21204504</b> 85x105x8 LD
						<b>21204017</b> 27x47x7 RD
<b>61706025</b> 0249.C1 0249.F8	<b>62427465</b>	<b>61706019x4</b> 0348.R2 0348.T8	<b>61706020</b> 0349.J8 0349.J7		<b>61706027x8</b> 0956.50 5,5x9,5x22,9x17,5	<b>21204018</b> 40x55x6,4 LD
						<b>21204019</b> 85x105x8,8 RD
						<b>21201018</b> 40x49,6x7.3 LD
<b>61205025</b> 0249.21	<b>61205013</b> 0304.09	<b>61205020</b> 0349.23	<b>61205018</b> 1710.11	<b>61205017</b> 1710.09		<b>21201029</b> 60,5x78x9 RD

■ : Delik - Çentik

■ : Hole - Notch

■ : Trou - Entaille

NOT: Katalogdaki Orijinal Kodlar Referans Amacıyla Kullanılmıştır.Lütfen COTECH Kodlarını Kullanınız.  
Original codes used for reference only.Please use COTECH codes for orders.

00



01



02



03















04



Silindir Kapak  
Cylinder Head  
Zylinderkopf  
Joint de culasse



Ltr	MODEL	PS/KW	ENGINE/MOTOR		
1,6 1560	<b>4 CYL ø75</b> EXPRESS TD 02/04--> PARTNER HDI 1007 HDI 206 CC HDI FAP 110 206 HDI FAP 110 206 SW HDI FAP 110 207 CC HDI 207 HDI 3008 HDI 307 D 307 HDI 307 HDI 110 FAP 307 SW HDI 110 FAP 308 HDI 407 HDI 110 FAP 407 SW HDI 110 FAP 5008 HDI	110 PS / 80 KW 90 PS / 66 KW	DV6ATED4 (9HX) DV6TED4 (9HY) DV6TED4 (9HZ)	<b>61707002</b> Motor Full Takım Gasket Full Set  <b>61707003</b> Motor Üst Takım Gasket Head Set  <b>61707004</b> Motor Alt Takım Conversion Set	 <b>61707005</b> 0209.CG 1,45mm 5  <b>61707006</b> 0209.CF 1,40mm 4  <b>61707007</b> 0209.CC 1,30mm 3  <b>61707008</b> 0209.CA 1,25mm 2  <b>61707009</b> 0209.CE 1,35mm 1  MLS ø76
1,6 1580	<b>4 CYL ø83</b> 205 10/82--> 205 GTI 305 309	103 PS / 76 KW 72 PS / 53 KW	XU5CP (BAZ) XU5J (B6B) XU5J (180A) XU5J (180Z) XU5S (171) XU51C (B1A) XU51C (B1D) XU51C (B1E)	<b>61207002</b> 0197.89+0209.E1 <b>61207003</b> 0197.H6+0209.E1 <b>62130002</b> 0197.89+0209.L3 <b>62130003</b> 0197.H6+0209.L3	 <b>61207005</b> 0209.E1 1,30mm 1  <b>61207006</b> 0209.L8 1,50mm 2   <b>62130005</b> 0209.L3 1,50mm ø84,5

▲ : İçerikte Bulunmamaktadır...

▲ : Not included in the set

▲ : Non inclus dans la pochette

00: Motor Takım Keçesiz ve Subap Lastiksiz











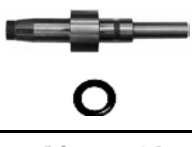
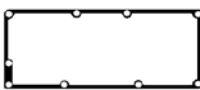







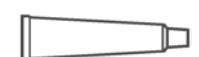

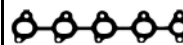

00: Gasket Set Without oil seals Without Valve Stem Seal

01: Motor Takım Keçesiz - Subap Lastikli

01: Gasket set With Valve Stem Seal Without Oil Seals

02: Motor Full Takım Keçeli ve Subap Lastikli

02: Gasket Full Set With oil seals and Valve Stem Seals

Subap Kapak Valve Cover Gasket Zylinderkopfhaube Couvre-culbut.	Karter Oil Pan Ölwanne Carter d'huile	Emme Manifold Intake Manifold Ansaug Admission	Egzoz Manifold Exhaust Manifold Auspuffkrümmer Collecteur D'echappement	Eksoz Boğaz Exhaust Pipe Auspuff Kehle	Supap Keçesi Valve Stem Seal Ventilschaft Queue de soupape	
						
 <b>61707025</b> 0249.C2	 <b>62427465</b>	 0348.R5 x4  0348.R4 x4 <b>61707018</b> 0348.R5+0348.R4 <b>SET</b>	 <b>61706021</b> 0349.J8 0349.J7 0349.N0 1 148 115		 <b>61707026x16</b> 0956.51 <b>5,5x9,5x18,1x14</b>	<b>21204017</b> 27x47x7 RD <b>21204018</b> 40X55X6,4 LD <b>21204019</b> 85X105X8,8 RD
 <b>61207525</b> 0249.48 91508054	 <b>61203013</b> 0304.34 93502226  <b>61203014</b> 93501565	 <b>61203018x2</b> 91508659.  <b>61207018</b> 951299280  <b>61207019</b> 0348.76	 <b>61207020x4</b> 0349.70 91505500  <b>61205019</b> 1721.01 7810024000	 <b>61207017</b> 1710.39 91511460	 <b>60107027x8</b> 0956.22 <b>8x10,8/14,2x10</b>	<b>21201062</b> 36x50x7 RD <b>21201019</b> 42x62x8 RD <b>21201040</b> 90x110x10 LD

■ : Delik - Çentik

■ : Hole - Notch

■ : Trou - Entaille

NOT: Katalogdaki Orjinal Kodlar Referans Amacıyla Kullanılmıştır.Lütfen COTECH Kodlarını Kullanınız.  
Original codes used for reference only.Please use COTECH codes for orders.

00



Silindir Kapak

Cylinder Head

01



Zylinderkopf

02



Joint de culasse

03



04



Ltr	MODEL	PS/KW	ENGINE/MOTOR		
1,6 1580	<b>4 CYL ø83</b> 205 205 GTI 309 405 07/87-->09/98	103 PS / 76 KW 72 PS / 53 KW	XU5CP (BAZ) XU5J (180A) XU5J (180Z) XU5M (BDY) XU5M (BDZ) XU5S (171) XU51C (B1A) XU51C (B1E) XU52C/K (B2A)	<b>61207002</b> 0197.89+0209.E1  <b>61207003</b> 0197.H6+0209.E1  <b>62130002</b> 0197.89+0209.L3  <b>62130003</b> 0197.H6+0209.L3	 <b>61207005</b> 0209.E1 1,30mm 1  <b>61207006</b> 0209.L8 1,50mm 2  <b>62130005</b> 0209.L3 1,50mm <b>ø84,5</b>
1,6 1580	<b>4 CYL ø83</b> 405 406 08/92-->05/04	88 PS / 65 KW	XU5JP(BFZ)	<b>61233002</b> 0197.G4+0209.E1	 <b>61207005</b> 0209.E1 1,30mm 1  <b>61207006</b> 0209.L8 1,50mm 2  <b>62130005</b> 0209.L3 1,50mm <b>ø84,5</b>
1,6 1581	<b>4 CYL ø86,4</b> EXPERT 02/96-->	79 PS / 58 KW	222A2(1580SPI)	<b>60304002</b> 5890649  <b>60304001</b>	 <b>60304005</b> 0209.P9 1,80mm <b>ø87</b>

▲ : İçerikte Bulunmamaktadır...

▲ : Not included in the set

▲ : Non inclus dans la pochette

00: Motor Takım Keçesiz ve Subap Lastiksiz











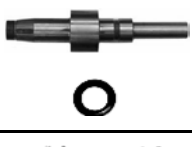
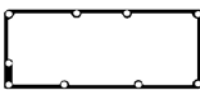















00: Gasket Set Without oil seals Without Valve Stem Seal

01: Motor Takım Keçesiz - Subap Lastikli

01: Gasket set With Valve Stem Seal Without Oil Seals

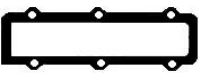
02: Motor Full Takım Keçeli ve Subap Lastikli

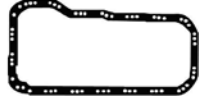
02: Gasket Full Set With oil seals and Valve Stem Seals

Subap Kapak Valve Cover Gasket Zylinderkopfhaube Couvre-culbut.	Karter Oil Pan Ölwanne Carter d'huile	Emme Manifold Intake Manifold Ansaug Admission	Egzoz Manifold Exhaust Manifold Auspuffkrümmer Collecteur D'echappement	Eksoz Boğaz Exhaust Pipe Auspuff Kehle	Supap Keçesi Valve Stem Seal Ventilschaft Queue de soupape	
						
 <b>61207525</b> 0249.48 91508054	 <b>61203013</b> 0304.34 93502226  <b>61203014</b> 93501565	 <b>61203018x2</b> 91508659.  <b>61207018</b> 951299280  <b>61207019</b> 0348.76	 <b>61207020x4</b> 0349.70 91505500  <b>61205019</b> 1721.01 7810024000	 <b>61207017</b> 1710.39 91511460	 <b>60107027x8</b> 0956.22 <b>8x10,8/14,2x10</b>	<b>21201062</b> 36x50x7 RD <b>21201019</b> 42x62x8 RD <b>21201040</b> 90x110x10 LD
 <b>61233025</b> 0249.71	 <b>61203013</b> 0304.34 93502226.	 <b>61233018x4</b> 0348.E6 + 0348F6	 <b>61233020x4</b> 1723.63		 <b>60107027x8</b> 0956.22 <b>8x10,8/14,2x10</b>	<b>21201062</b> 36x50x7 RD <b>21201019</b> 42x62x8 RD <b>21201040</b> 90x110x10 LD
 <b>60304034</b> 0249.83  <b>60304035</b> 0249.84	 <b>60304013</b> 0304.49	 <b>60304020</b> 7772495			 <b>60107027x8</b> 0956.22 <b>8x10,8/14,2x10</b>	<b>21201006x2</b> 30x52x7 RD <b>21201017</b> 40x56x7 RD <b>21201030</b> 64x80x8 LD

■ : Delik - Çentik

■ : Hole - Notch

■ : Trou - Entaille

NOT: Katalogdaki Orijinal Kodlar Referans Amacıyla Kullanılmıştır.Lütfen COTECH Kodlarını Kullanınız.  
Original codes used for reference only.Please use COTECH codes for orders.

00



Silindir Kapak

Cylinder Head

01



Zylinderkopf

02



Joint de culasse

03



04



Ltr	MODEL	PS/KW	ENGINE/MOTOR		
1,6 1587	<b>4 CYL ø78,5</b> PARTNER 08/00--> PARTNER 16V 1007 16V 206 206 CC 16V 206 SW 16V 206 16V 207 307 307 CC 16V 307 SW 16V 307 16V 308	112 PS / 82 KW 106 PS / 78 KW	TU5JP4 (NFU) TU5JP4 (N6A)		 <b>62200005</b> 0209.1E MLS ø79,5
1,6 1618	<b>4 CYL ø84</b> 504 01/80-->06/87 J7 08/68-->03/80 J9 03/80-->06/87	60 PS / 44 KW 63 PS / 46 KW	XC7P	<b>61210001</b> 0197.L1	 <b>61210005</b> 0209.F8 ø86,7
1,8 1761	<b>4 CYL ø83</b> 306 05/93-->04/02 405 08/92-->10/96 406 05/97-->10/04 PARTNER 05/97--> EXPERT	101 PS / 74 KW 88 PS / 65 KW	XU7JP(LFZ) XU7JB(LFX)	<b>61233002</b> 0197.G4+0209.E1	 <b>61207005</b> 0209.E1 1,30mm 1 <b>61207006</b> 0209.L8 1,50mm 2  <b>62130005</b> 0209.L3 1,50mm ø84,5

▲ : İçerikte Bulunmamaktadır...

▲ : Not included in the set

▲ : Non inclus dans la pochette

00: Motor Takım Keçesiz ve Subap Lastiksiz











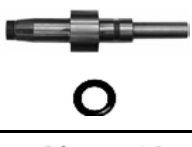
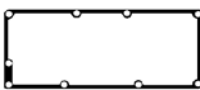



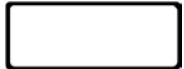

00: Gasket Set Without oil seals Without Valve Stem Seal

01: Motor Takım Keçesiz - Subap Lastikli

01: Gasket set With Valve Stem Seal Without Oil Seals

02: Motor Full Takım Keçeli ve Subap Lastikli

02: Gasket Full Set With oil seals and Valve Stem Seals

Subap Kapak Valve Cover Gasket Zylinderkopfhaube Couvre-culbut.	Karter Oil Pan Ölwanne Carter d'huile	Emme Manifold Intake Manifold Ansaug Admission	Egzoz Manifold Exhaust Manifold Auspuffkrümmer Collecteur D'echappement	Eksoz Boğaz Exhaust Pipe Auspuff Kehle	Supap Keçesi Valve Stem Seal Ventilschaft Queue de soupape	
						
						
61210525 0249.14	61210013 0304.44	61211016 0348.33	61210020 0349.03		60107027x8 0956.22 8x10,8/14,2x10	
						21201062 36x50x7 RD
61233025 0249.71	61203013 0304.34 93502226.	61233018x4 0348.E6 + 0348F6	61233020x4 1723.63		60107027x8 0956.22 8x10,8/14,2x10	21201019 42x62x8 RD  21201040 90x110x10 LD

■ : Delik - Çentik

■ : Hole - Notch

■ : Trou - Entaille

NOT: Katalogdaki Orjinal Kodlar Referans Amacıyla Kullanılmıştır.Lütfen COTECH Kodlarını Kullanınız.  
Original codes used for reference only.Please use COTECH codes for orders.

00



01



02



03



04



Silindir Kapak  
Cylinder Head  
Zylinderkopf  
Joint de culasse

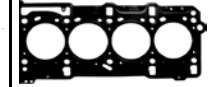

Ltr	MODEL	PS/KW	ENGINE/MOTOR		
1,8 1761	<b>4 CYL ø83</b> 306 16V 03/97-->04/02 406 16V 11/95-->10/00	110 PS / 81 KW	XU7JP4(LFY)		 <b>62220005</b> 0209.Q3 1,20mm 1 <b>62220006</b> 0209.V4 1,40mm 2 <b>62220007</b> 1,60mm 3 <b>ø84</b>
1,8 1769	<b>4 CYL ø80</b> PARTNER D 11/82--> 205 D 305 D 306 306 D 309 D	60 PS / 44 KW 58 PS / 43 KW	XUD7 (A9A) XUD7 (161A) 161 (XUD7) 161A (XUD7)	<b>61204002</b> 0197.H5  <b>61204003</b> 0197.H4 	 <b>61203009</b> 0209.S0 1,36 mm. 1 <b>61203008</b> 0209.S1 1,40 mm. 2 <b>61203007</b> 0209.S2 1,44 mm. 3 <b>61203006</b> 0209.S3 1,48 mm. 4 <b>61203005</b> 0209. S4 1,53 mm. 5 <b>ø82</b>
1,8 1769	<b>4 CYL ø80</b> 205 10/87-->09/98 205 TD 309 TD 405 D 405 DT 405 TD	90 PS / 66 KW 78 PS / 57 KW	XUD7T XUD7TE (AJZ) XUD7TE (A8A) XUD7TE (A8B)	<b>61204002</b> 0197.H5  <b>61204003</b> 0197.H4 	

▲ : İçerikte Bulunmamaktadır...

▲ : Not included in the set

▲ : Non inclus dans la pochette

00: Motor Takım Keçesiz ve Subap Lastiksiz











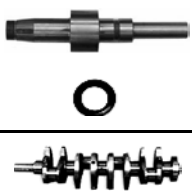
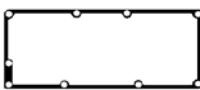





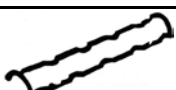
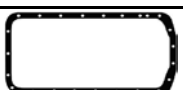



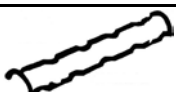

00: Gasket Set Without oil seals Without Valve Stem Seal

01: Motor Takım Keçesiz - Subap Lastikli

01: Gasket set With Valve Stem Seal Without Oil Seals

02: Motor Full Takım Keçeli ve Subap Lastikli

02: Gasket Full Set With oil seals and Valve Stem Seals

Subap Kapak Valve Cover Gasket Zylinderkopfhaube Couvre-culbut.	Karter Oil Pan Ölwanne Carter d'huile	Emme Manifold Intake Manifold Ansaug Admission	Egzoz Manifold Exhaust Manifold Auspuffkrümmer Collecteur D'echappement	Eksoz Boğaz Exhaust Pipe Auspuff Kehle	Supap Keçesi Valve Stem Seal Ventilschaft Queue de soupape	
						
 <b>61203525</b> 0249.46 0249.91	 <b>61203013</b> 0304.34   <b>61203014</b> 93501565	 <b>61203116x2</b> 0348.99   <b>61203018x2</b> 91508659   <b>61203021</b> 0348.JO	 <b>61205019</b> 1721.01 7810024000   <b>61203120x2</b> 0349.47 93010402		 <b>60107027x8</b> 0956.22 8x10,8/14,2x10	<b>21201011x2</b> 35x50x8 WD  <b>21201019</b> 42x62x8 RD  <b>21201040</b> 90x110x7 LD
 <b>61203525</b> 0249.46 0249.91	 <b>61203013</b> 0304.34   <b>61203014</b> 93501565	 <b>61203116x2</b> 0348.99   <b>61203018x2</b> 91508659   <b>61203021</b> 0348.JO	 <b>61205019</b> 1721.01 7810024000   <b>61203120x2</b> 0349.47 93010402		 <b>60107027x8</b> 0956.22 8x10,8/14,2x10	<b>21201011x2</b> 35x50x8 WD  <b>21201019</b> 42x62x8 RD  <b>21201040</b> 90x110x7 LD

■ : Delik - Çentik

■ : Hole - Notch

■ : Trou - Entaille

NOT: Katalogdaki Orijinal Kodlar Referans Amacıyla Kullanılmıştır.Lütfen COTECH Kodlarını Kullanınız.  
Original codes used for reference only.Please use COTECH codes for orders.

00



01



02



03



04



Silindir Kapak  
Cylinder Head  
Zylinderkopf  
Joint de culasse



Ltr	MODEL	PS/KW	ENGINE/MOTOR		
1,8 1796	<b>4 CYL ø84</b> 504 07/68-->12/89 505 06/81-->10/86 J5 01/83-->11/88 J7 07/70-->03/80	65 PS / 48 KW 69 PS / 51 KW 73 PS / 54 KW 82 PS / 60 KW 84 PS / 62 KW	105 (XM7) 169B(XM7T) XM XM7 XM7P	61210001 0197.L1 0197.15	 <b>61210005</b> 0209.F8 ø86,7
1,9 1868	<b>4 CYL ø82,2</b> EXPERT D 06/96--> PARTNER D 206 D 306 D	69 PS / 51 KW	DW8 (WJZ) DW8B (WJY)	62173002 0197.X6	 <b>62173005</b> 0209.1C 1,47mm <b>62173006</b> 0209.X4 1,42mm 5 <b>62173007</b> 0209.X3 1,38mm 4 <b>62173008</b> 0209.X2 1,34mm 3 <b>62173009</b> 0209.X1 1,30mm 2 <b>62173010</b> 0209.X0 1,26mm 1 MLS ø84
1,9 1905	<b>4 CYL ø83</b> 205 09/84-->07/89 205 GTI 305 309 309 GTI	128 PS / 94 KW 98 PS / 72 KW	XU9JA (D6B) XU9J1 (DFZ) XU9S (D2B) XU9S (159)	61207002 0197.89+0209.E1  61207003 0197.H6+0209.E1  62130002 0197.89+0209.L3  62130003 0197.H6+0209.L3	 <b>61207005</b> 0209.E1 1,30mm 1  <b>61207006</b> 0209.L8 1,50mm 2  <b>62130005</b> 0209.L3 1,50mm ø84,5

▲ : İçerikte Bulunmamaktadır...

▲ : Not included in the set

▲ : Non inclus dans la pochette

00: Motor Takım Keçesiz ve Subap Lastiksiz











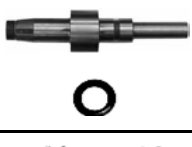
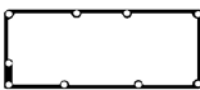





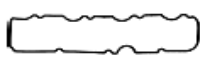

00: Gasket Set Without oil seals Without Valve Stem Seal

01: Motor Takım Keçesiz - Subap Lastikli

01: Gasket set With Valve Stem Seal Without Oil Seals

02: Motor Full Takım Keçeli ve Subap Lastikli

02: Gasket Full Set With oil seals and Valve Stem Seals

Subap Kapak Valve Cover Gasket Zylinderkopfhaube Couvre-culbut.	Karter Oil Pan Ölwanne Carter d'huile	Emme Manifold Intake Manifold Ansaug Admission	Egzoz Manifold Exhaust Manifold Auspuffkrümmer Collecteur D'echappement	Eksoz Boğaz Exhaust Pipe Auspuff Kehle	Supap Keçesi Valve Stem Seal Ventilschaft Queue de soupape	
						
61210525 0249.14	61210013 0304.44	61211016 0348.33	61210020 0349.03		60107027x8 0956.22 8x10,8/14,2x10	
						21208023 35x50x8 RD
62173025 0249.95	61203013 0304.34	62173018x2 0348.N2	62173021x2 0349.H7		60107027x8 0956.22 8x10,8/14,2x10	21201019 42x62x8 RD
						21201040 90x110x10 LD
						21201062 36x50x7 RD
61207525 0249.48 91508054	61203013 0304.34 93502226 61203014 93501565	61203018x2 91508659.  61207018 951299280  61207019 0348.76	61207020x4 0349.70 91505500 61205019 1721.01 7810024000	61207017 1710.39 91511460	60107027x8 0956.22 8x10,8/14,2x10	21201019 42x62x8 RD
						21201040 90x110x10 LD

■ : Delik - Çentik

■ : Hole - Notch

■ : Trou - Entaille

NOT: Katalogdaki Orijinal Kodlar Referans Amacıyla Kullanılmıştır.Lütfen COTECH Kodlarını Kullanınız.  
Original codes used for reference only.Please use COTECH codes for orders.

00



01



02



03



04



Silindir Kapak  
Cylinder Head  
Zylinderkopf  
Joint de culasse



Ltr	MODEL	PS/KW	ENGINE/MOTOR			
1,9 1905	<b>4 CYL ø83</b> 205 205 CTI 205 GTI 309 309 GTI 405 405	06/87-->05/97      01/89-->12/92	121 PS / 89 KW 95 PS / 70 KW     122 PS / 90 KW	XU9JAZ (DKZ) XU9J1 (DFZ) XU9M (DDZ) XU92C (D2A) XU92C (D2C)  XU9J2 (D6A)	<b>61207002</b> 0197.89+0209.E1  <b>61207003</b> 0197.H6+0209.E1  <b>62130002</b> 0197.89+0209.L3  <b>62130003</b> 0197.H6+0209.L3	 <b>61207005</b> 0209.E1 1,30mm 1  <b>61207006</b> 0209.L8 1,50mm 2  <b>62130005</b> 0209.L3 1,50mm <b>ø84,5</b>
1,9 1905	<b>4 CYL ø83</b> 309 GTI 16V 405		158 PS / 116 KW 147 PS / 108 KW	XU9J4 (D6C) XU9J4Z (DFW)	 <b>62130005</b> 0209.L3 1,50mm <b>ø84,5</b>	
1,9 1905	<b>4 CYL ø83</b> J5 J5 D PARTNER D 205 D 305 D 306 D 306 SLD 306 STD 309 D 405 D 305 D 309 D	10/82-->05/01           10/82-->12/93 10/82-->12/93	69 PS / 51 KW 64 PS / 47 KW     64 PS / 47 KW 64 PS / 47 KW	XUD9 XUD9 (DJZ) XUD9 (162)    XUD9 (D9A) XUD9 (D9A)	<b>61204002</b> 0197.H5   <b>61204003</b> 0197.H4 	 <b>61204009</b> 0209.S5 1,36 mm 1 <b>61204008</b> 0209.S6 1,40 mm 2 <b>61204007</b> 0209.S7 1,44 mm 3 <b>61204006</b> 0209.S8 1,48 mm 4 <b>61204005</b> 0209.S9 1,53 mm 5 <b>ø 84</b>

▲ : İçerikte Bulunmamaktadır...

▲ : Not included in the set

▲ : Non inclus dans la pochette

00: Motor Takım Keçesiz ve Subap Lastiksiz











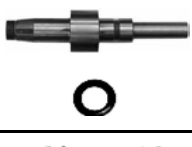
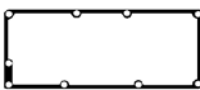















00: Gasket Set Without oil seals Without Valve Stem Seal

01: Motor Takım Keçesiz - Subap Lastikli

01: Gasket set With Valve Stem Seal Without Oil Seals

02: Motor Full Takım Keçeli ve Subap Lastikli

02: Gasket Full Set With oil seals and Valve Stem Seals

Subap Kapak Valve Cover Gasket Zylinderkopfhaube Couvre-culbut.	Karter Oil Pan Ölwanne Carter d'huile	Emme Manifold Intake Manifold Ansaug Admission	Egzoz Manifold Exhaust Manifold Auspuffkrümmer Collecteur D'echappement	Eksoz Boğaz Exhaust Pipe Auspuff Kehle	Supap Keçesi Valve Stem Seal Ventilschaft Queue de soupape	
						
 <b>61207525</b> 0249.48 91508054	 <b>61203013</b> 0304.34 93502226  <b>61203014</b> 93501565	 <b>61203018x2</b> 91508659.  <b>61207018</b> 951299280  <b>61207019</b> 0348.76	 <b>61207020x4</b> 0349.70 91505500  <b>61205019</b> 1721.01 7810024000	 <b>61207017</b> 1710.39 91511460	 <b>60107027x8</b> 0956.22 <b>8x10,8/14,2x10</b>	<b>21201062</b> 36x50x7 RD <b>21201019</b> 42x62x8 RD <b>21201040</b> 90x110x10 LD
 <b>61203525</b> 0249.46 0249.91	 <b>61203013</b> 0304.34  <b>61203014</b> 93501565	 <b>61203116x2</b> 0348.99  <b>61203018x2</b> 91508659  <b>61203021</b> 0348.JO	 <b>61205019</b> 1721.01 7810024000  <b>61203120x2</b> 0349.47 93010402		 <b>60107027x8</b> 0956.22 <b>8x10,8/14,2x10</b>	<b>21201011x2</b> 35x50x8 WD <b>21201019</b> 42x62x8 RD <b>21201040</b> 90x110x7 LD

■ : Delik - Çentik

■ : Hole - Notch

■ : Trou - Entaille

NOT: Katalogdaki Orjinal Kodlar Referans Amacıyla Kullanılmıştır.Lütfen COTECH Kodlarını Kullanınız.  
Original codes used for reference only.Please use COTECH codes for orders.

00



01



02



03













04



Silindir Kapak  
Cylinder Head  
Zylinderkopf  
Joint de culasse



Ltr	MODEL	PS/KW	ENGINE/MOTOR		
1,9 1905	<b>4 CYL ø83</b> BOXER Bus D 03/88--> BOXER D EXPERT D J5 Bus D J5 D PARTNER D 306 D 306 SLD 405 D	70 PS / 51 KW 68 PS / 50 KW	XUD9A (DJY) XUD9A (D9B) XUD9AU (D8C)	<b>61204002</b> 0197.H5  <b>61204003</b> 0197.H4 	 <b>61204009</b> 0209.S5 1,36 mm 1  <b>61204008</b> 0209.S6 1,40 mm 2  <b>61204007</b> 0209.S7 1,44 mm 3  <b>61204006</b> 0209.S8 1,48 mm 4  <b>61204005</b> 0209.S9 1,53 mm 5  <b>ø 84</b>
1,9 1905	<b>4 CYL ø83</b> BOXER 08/92--> BOXER Bus TD BOXER TD EXPERT DT EXPERT TD 306 D 306 DT 306 SRDT 306 TD 405 TD 406 D 406 TD 806 TD	94 PS / 69 KW 75 PS / 55 KW	XUD9BSD (DHV) XUD9SD (DHW) XUD9TE XUD9TE (DHX) XUD9TE (DHY) XUD9TE (D8B) XUD9UTF (D8C)	<b>61204002</b> 0197.H5  <b>61204003</b> 0197.H4 	
1,9 1948	<b>4 CYL ø88</b> 504 03/73-->12/89 J7 08/68-->07/78	55 PS / 40 KW	XDP88 XD4X88	<b>61212002</b> 0198.40	 <b>61212005</b> 0203.70 1,60mm <b>61212006</b> 0209.L2 1,80mm <b>ø94</b>

▲ : İçerikte Bulunmamaktadır...

▲ : Not included in the set

▲ : Non inclus dans la pochette

00: Motor Takım Keçesiz ve Subap Lastiksiz











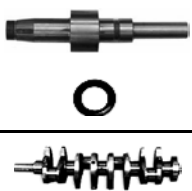
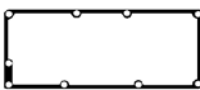





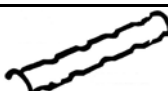



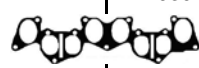



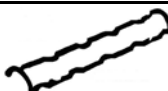



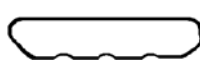

00: Gasket Set Without oil seals Without Valve Stem Seal

01: Motor Takım Keçesiz - Subap Lastikli

01: Gasket set With Valve Stem Seal Without Oil Seals

02: Motor Full Takım Keçeli ve Subap Lastikli

02: Gasket Full Set With oil seals and Valve Stem Seals

Subap Kapak Valve Cover Gasket Zylinderkopfhaube Couvre-culbut.	Karter Oil Pan Ölwanne Carter d'huile	Emme Manifold Intake Manifold Ansaug Admission	Egzoz Manifold Exhaust Manifold Auspuffkrümmer Collecteur D'echappement	Eksoz Boğaz Exhaust Pipe Auspuff Kehle	Supap Keçesi Valve Stem Seal Ventilschaft Queue de soupape	
						
 <b>61203525</b> 0249.46 0249.91	 <b>61203013</b> 0304.34  <b>61203014</b> 93501565	 <b>61203116x2</b> 0348.99  <b>61203018x2</b> 91508659  <b>61203021</b> 0348.JO	 <b>61205019</b> 1721.01 7810024000  <b>61203120x2</b> 0349.47 93010402		 <b>60107027x8</b> 0956.22 8x10,8/14,2x10	<b>21201011x2</b> 35x50x8 WD <b>21201019</b> 42x62x8 RD <b>21201040</b> 90x110x7 LD
 <b>61203525</b> 0249.46 0249.91	 <b>61203013</b> 0304.34  <b>61203014</b> 93501565	 <b>61203116x2</b> 0348.99  <b>61203018x2</b> 91508659  <b>61203021</b> 0348.JO	 <b>61205019</b> 1721.01 7810024000  <b>61203120x2</b> 0349.47 93010402		 <b>60107027x8</b> 0956.22 8x10,8/14,2x10	<b>21201011x2</b> 35x50x8 WD <b>21201019</b> 42x62x8 RD <b>21201040</b> 90x110x7 LD
 <b>61212525</b> 0249.25	 <b>61212014</b> 0313.19  <b>61212015</b> 0304.12	 <b>61212016x3</b> 0348.11	 <b>61212020x2</b> 0349.08	 <b>61205018</b> 1710.07  <b>61212018</b> 1710.15  <b>61212019</b> 1710.19		<b>21201020</b> 42x60x10 RD

■ : Delik - Çentik

■ : Hole - Notch

■ : Trou - Entaille

NOT: Katalogdaki Orjinal Kodlar Referans Amacıyla Kullanılmıştır.Lütfen COTECH Kodlarını Kullanınız.  
Original codes used for reference only.Please use COTECH codes for orders.

00



Silindir Kapak

Cylinder Head

01



Zylinderkopf

02







Joint de culasse

03



04



Ltr	MODEL	PS/KW	ENGINE/MOTOR		
2.0	4 CYL ø88				
1971	504	03/71-->07/86	97 PS / 71 KW	XN1	<b>61211001</b> 9400197139   <b>61211005</b> 0209.46 1,20mm  <b>61211006</b> 0209.46 1,80mm ø90
	505		92 PS / 68 KW	XN1 (106)	
	504	09/79-->08/82	94 PS / 69 KW	XN1	
	505	09/85-->09/91	98 PS / 72 KW	XN1A(106E)	
	J5	03/80-->08/90	79 PS / 58 KW	XN1P	
	J9		78 PS / 57 KW		
	J9 Bus				
	J5	09/87-->08/90	75 PS / 55 KW	XN1T	
	J5 Bus	09/81-->	85 PS / 62 KW	XN1T (170)	
	J5	09/90-->01/94	75 PS / 55 KW	XN1T (170B)	
			94 PS / 69 KW	XN1TA (170C)	
			84 PS / 62 KW	XN1TA	
	504	01/71-->08/84	106 PS / 78 KW	XN2(107)	
2.0	4 CYL ø86				
1998	306 16V	03/97-->04/02	132 PS / 97 KW	XU10J4R (RFV)	 <b>62170005</b> 0209.N6 1.35 mm 1   <b>62170006</b> 0209.T9 1,50mm 2   <b>ø87</b>
	406 16V	11/95-->10/04			
	605 16V	07/94-->09/99			
	806 16V	05/98-->09/00			

▲ : İçerikte Bulunmamaktadır...

▲ : Not included in the set

▲ : Non inclus dans la pochette

00: Motor Takım Keçesiz ve Subap Lastiksiz











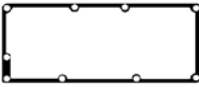

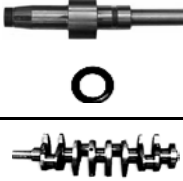

00: Gasket Set Without oil seals Without Valve Stem Seal

01: Motor Takım Keçesiz - Subap Lastikli

01: Gasket set With Valve Stem Seal Without Oil Seals

02: Motor Full Takım Keçeli ve Subap Lastikli

02: Gasket Full Set With oil seals and Valve Stem Seals

<p>Subap Kapak Valve Cover Gasket Zylinderkopfhaube Couvre-culbut.</p> 	<p>Karter Oil Pan Ölwanne Carter d'huile</p> 	<p>Emme Manifold Intake Manifold Ansaug Admission</p> 	<p>Egzoz Manifold Exhaust Manifold Auspuffkrümmer Collecteur D'echappement</p> 	<p>Eksoz Boğaz Exhaust Pipe Auspuff Kehle</p> 	<p>Supap Keçesi Valve Stem Seal Ventilschaft Queue de soupape</p> 	
 <p><b>61210525</b> 0249.14</p>	 <p><b>61210013</b> 0322.10 0304.11</p>	 <p><b>61211016</b> 0348.33</p>  <p><b>61211015</b> 0348.21</p>	 <p><b>61210020</b> 0349.03</p>  <p><b>61205017</b> 1710.09</p>  <p><b>61212019</b> 1710.19</p>		 <p><b>60107027x8</b> 0956.22 8x10,8/14,2x10</p>	

■ : Delik - Çentik

■ : Hole - Notch

■ : Trou - Entaille

NOT: Katalogdaki Orijinal Kodlar Referans Amacıyla Kullanılmıştır.Lütfen COTECH Kodlarını Kullanınız.  
Original codes used for reference only.Please use COTECH codes for orders.

00



01



02



03







04



Silindir Kapak  
Cylinder Head  
Zylinderkopf  
Joint de culasse



Ltr	MODEL	PS/KW	ENGINE/MOTOR		
2,1 2112	<b>4 CYL ø90</b> J9 D 03/80-->06/87 J7 Bus D 08/98-->07/86 J7 D 504 D	56 PS / 41 KW 65 PS / 48 KW 57 PS / 42 KW	XDPX90 XDP90 XD4x90	<b>61212002</b> 0198.40	 <b>61212005</b> 0203.70 1,60mm <b>61212006</b> 0209.L2 1,80mm <b>ø94</b>
2,3 2304	<b>4 CYL ø94</b> 504 07/75-->12/89 J7 Bus D 07/77-->07/82 J7 D J9 Bus D J9 D 505 D 09/79-->06/86 505 TD 604 TD	69 PS / 51 KW 67 PS / 49 KW 80 PS / 59 KW	XD2(134) XD2PX94 XD2P94 XD2S (147)	<b>61218000</b> 0198.94 	 <b>61218005</b> 0209.C6 1,73mm 4 <b>M</b> <b>61218006</b> 0209.C4 1,63mm 3 <b>M</b> <b>61218006</b> 0209.C2 1,53mm 2 <b>M</b> <b>ø96</b>
2,5 2498	<b>4 CYL ø94</b> 505 D 06/81-->12/93 J9 Bus D 07/82-->06/87 J9 D 505 TD 08/83--> 604 TD	75 PS / 55 KW 69 PS / 51 KW 72 PS / 53 KW 105 PS / 74 KW 73 PS / 54 KW	XD3 (155) XD3P XD3T (152A) XD3TE XD3TE (152B)	<b>61218000</b> 0198.94 	 <b>61218005</b> 0209.C6 1,73mm 4 <b>M</b> <b>61218006</b> 0209.C4 1,63mm 3 <b>M</b> <b>61218006</b> 0209.C2 1,53mm 2 <b>M</b> <b>ø96</b>

▲ : İçerikte Bulunmamaktadır...

▲ : Not included in the set

▲ : Non inclus dans la pochette

00: Motor Takım Keçesiz ve Subap Lastiksiz











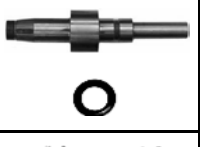
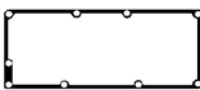





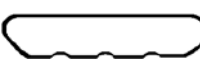











00: Gasket Set Without oil seals Without Valve Stem Seal

01: Motor Takım Keçesiz - Subap Lastikli

01: Gasket set With Valve Stem Seal Without Oil Seals

02: Motor Full Takım Keçeli ve Subap Lastikli

02: Gasket Full Set With oil seals and Valve Stem Seals

Subap Kapak Valve Cover Gasket Zylinderkopfhaube Couvre-culbut.	Karter Oil Pan Ölwanne Carter d'huile	Emme Manifold Intake Manifold Ansaug Admission	Egzoz Manifold Exhaust Manifold Auspuffkrümmer Collecteur D'echappement	Eksoz Boğaz Exhaust Pipe Auspuff Kehle	Supap Keçesi Valve Stem Seal Ventilschaft Queue de soupape	
						
 <b>61212525</b> 0249.25	 <b>61212014</b> 0313.19  <b>61212015</b> 0304.12	 <b>61212016x3</b> 0348.11	 <b>61212020x2</b> 0349.08	 <b>61205018</b> 1710.07  <b>61212018</b> 1710.15  <b>61212019</b> 1710.19		<b>21201020</b> 42x60x10 RD
 <b>61212525</b> 0249.25	 <b>61212014</b> 0313.19  <b>61212015</b> 0304.12	 <b>61212016x3</b> 0348.11	 <b>61212020x2</b> 0349.10	 <b>61212018</b> 1710.15  <b>61212019</b> 1710.19		
 <b>61212525</b> 0249.25	 <b>61212014</b> 0313.19  <b>61212015</b> 0304.12	 <b>61212016x3</b> 0348.11	 <b>61212020x2</b> 0349.10	 <b>61212018</b> 1710.15  <b>61212019</b> 1710.19		

■ : Delik - Çentik

■ : Hole - Notch

■ : Trou - Entaille

NOT: Katalogdaki Orijinal Kodlar Referans Amacıyla Kullanılmıştır.Lütfen COTECH Kodlarını Kullanınız.  
Original codes used for reference only.Please use COTECH codes for orders.

00



01



02



03



04



Silindir Kapak  
Cylinder Head  
Zylinderkopf  
Joint de culasse



Ltr	MODEL	PS/KW	ENGINE/MOTOR		
2,5 2500	<b>4 CYL ø93</b> J5 J5 Bus D J5 D J5 DT 09/81--> 09/81-->01/94	73 PS / 54 KW 95 PS / 70 KW	CRD93 CRD93L	<b>61215003</b> 0197.K1	 <b>61215005</b> 0209.L5 1,40mm ø95,5
2,5 2500	<b>4 CYL ø93</b> J5 Bus TD J5 TD 10/90-->	95 PS / 70 KW	CRD93LS	<b>61215103</b> 0197.R9	 <b>61215105</b> 0209.L6 1,40mm ø95,5
2,7 2664	<b>6 CYL ø88</b> 604 504 604 08/77-->05/83 08/77-->08/84	136 PS / 100 KW 144 PS / 106 KW	ZM(112) ZMJ(140)		 0203.67 1,20mm  0203.66 1,20mm ø90 <b>60115005</b>
2,8 2799	<b>4 CYL ø94,4</b> BOXER BOXER DTIC BOXER TD BOXER HDI BOXER BUS HDI 10/97-->03/05 10-00-->	122 PS / 90 KW 128 PS / 94 KW 126 PS / 93 KW	8140.43(F28DT) 8140.43S (F28DTCR)	<b>60139100</b> 71713696 	 <b>60139005</b> 0209.OF 1,50mm <b>60139006</b> 0209.OE 1,40mm <b>60139007</b> 0209.OC 1,30mm ø96

▲ : İçerikte Bulunmamaktadır...

▲ : Not included in the set

▲ : Non inclus dans la pochette

00: Motor Takım Keçesiz ve Subap Lastiksiz











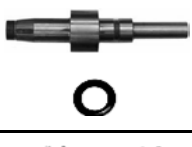
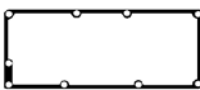







00: Gasket Set Without oil seals Without Valve Stem Seal

01: Motor Takım Keçesiz - Subap Lastikli

01: Gasket set With Valve Stem Seal Without Oil Seals

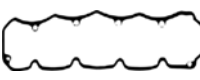
02: Motor Full Takım Keçeli ve Subap Lastikli

02: Gasket Full Set With oil seals and Valve Stem Seals

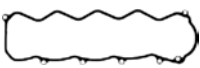
Subap Kapak Valve Cover Gasket Zylinderkopfhaube Couvre-culbut.	Karter Oil Pan Ölwanne Carter d'huile	Emme Manifold Intake Manifold Ansaug Admission	Egzoz Manifold Exhaust Manifold Auspuffkrümmer Collecteur D'echappement	Eksoz Boğaz Exhaust Pipe Auspuff Kehle	Supap Keçesi Valve Stem Seal Ventilschaft Queue de soupape	
						
 <b>61215025</b> 5 450 155		 <b>61215019x4</b> 0348.H0	 <b>61215021x4</b> 0349.F0	 <b>61215017</b> 95494600		
 <b>61215025</b> 5 450 155		 <b>61215019x4</b> 0348.H0	 <b>61215021x4</b> 0349.F0	 <b>61215017</b> 95494600		
 <b>60138045</b> 0249.AO	 <b>60138068</b> 500327440	 <b>60146019x4</b> 98425767	 <b>60147021x4</b> 98434020			
 <b>60138047</b> 0249.C3						

■ : Delik - Çentik

■ : Hole - Notch

■ : Trou - Entaille

NOT: Katalogdaki Orjinal Kodlar Referans Amacıyla Kullanılmıştır.Lütfen COTECH Kodlarını Kullanınız.  
Original codes used for reference only.Please use COTECH codes for orders.

**PROTON**

00



Silindir Kapak

Cylinder Head

01



Zylinderkopf

02



Joint de culasse

03



04



Ltr	MODEL	PS/KW	ENGINE/MOTOR		
1,1 1124	4 CYL ø72 TIARA 1996-->	60 PS / 44 KW	TU1	61209002 Motor Full Takım Gasket Full Set 61209003 0197.H8+0209.CJ 61209004 0197.H9	61209005 0209.CJ 1,30mm 1 ▲ 61209006 0209.W6 - W7 1,50 mm 2 ▲ ø76
1,3 1298	4 CYL ø71 SAGA 1985-->	77 PS / 56 KW	4G13		61507005 MD066163 1,40mm ø72,5
1,3 1298	4 CYL ø71 PERSONA 12V 01/94--> WIRA 12V ISWARA 12V SATRIA 12V	75 PS / 55 KW	4G13		61415405 MD323473 1,40mm ø76,5
1,5 1468	4 CYL ø75,5 SAGA 1985-->	75 PS / 55 KW	4G15		61500305 MD016163 1,40mm 61500306 MD016163 2,00mm ø76,5
1,5 1468	4 CYL ø75,5 PERSONA 12V 05/89-->08/99 WIRA 12V ISWARA 12V SATRIA 12V	90 PS / 66 KW 75 PS / 55 KW	4G15		61415405 MD323473 1,40mm ø76,5

▲ : İçerikte Bulunmamaktadır...

▲ : Not included in the set

▲ : Non inclus dans la pochette

00: Motor Takım Keçesiz ve Subap Lastiksiz











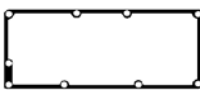

00: Gasket Set Without oil seals Without Valve Stem Seal

01: Motor Takım Keçesiz - Subap Lastikli

01: Gasket set With Valve Stem Seal Without Oil Seals

02: Motor Full Takım Keçeli ve Subap Lastikli

02: Gasket Full Set With oil seals and Valve Stem Seals





Subap Kapak Valve Cover Gasket Zylinderkopfhaube Couvre-culbut.	Karter Oil Pan Ölwanne Carter d'huile	Emme Manifold Intake Manifold Ansaug Admission	Egzoz Manifold Exhaust Manifold Auspuffkrümmer Collecteur D'echappement	Eksoz Boğaz Exhaust Pipe Auspuff Kehle	Supap Keçesi Valve Stem Seal Ventilschaft Queue de soupape	
						
						<b>21201062</b> 36x50x7 RD
<b>61209025</b> 0249.54	<b>61209013</b> 0304.304	<b>61209019x2</b>	<b>61209020x2</b> 0349,A6	<b>61209017</b> 1709.15	<b>60116026x8</b> 0956.19 7x9,8/13.2x10	<b>21201021</b> 42x66x6 RD
						<b>21204504</b> 85x105x8 LD

■ : Delik - Çentik

■ : Hole - Notch

■ : Trou - Entaille

NOT: Katalogdaki Orjinal Kodlar Referans Amacıyla Kullanılmıştır.Lütfen COTECH Kodlarını Kullanınız.  
Original codes used for reference only.Please use COTECH codes for orders.

00		Silindir Kapak Cylinder Head
01		Zylinderkopf Joint de culasse
02		
03		
04		

Ltr	MODEL	PS/KW	ENGINE/MOTOR	
1,6	4 CYL ø76,5 WAJA GEN-2 PERSONA 1995-->2006			 <b>61415605</b> PW811553 1,20mm FIBER / FIBRE <b>ø77,5</b>

▲ : İçerikte Bulunmamaktadır...

▲ : Not included in the set

▲ : Non inclus dans la pochette

00: Motor Takım Keçesiz ve Subap Lastiksiz







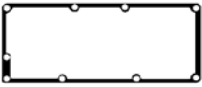
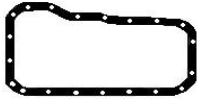

00: Gasket Set Without oil seals Without Valve Stem Seal

01: Motor Takım Keçesiz - Subap Lastikli

01: Gasket set With Valve Stem Seal Without Oil Seals

02: Motor Full Takım Keçeli ve Subap Lastikli

02: Gasket Full Set With oil seals and Valve Stem Seals

<p>Subap Kapak Valve Cover Gasket Zylinderkopfhaube Couvre-culbut.</p> 	<p>Karter Oil Pan Ölwanne Carter d'huile</p> 	<p>Emme Manifold Intake Manifold Ansaug Admission</p> 	<p>Egzoz Manifold Exhaust Manifold Auspuffkrümmer Collecteur D'echappement</p> 	<p>Eksoz Boğaz Exhaust Pipe Auspuff Kehle</p> 	<p>Supap Keçesi Valve Stem Seal Ventilschaft Queue de soupape</p> 	  

■ : Delik - Çentik

■ : Hole - Notch

■ : Trou - Entaille

NOT: Katalogdaki Orijinal Kodlar Referans Amacıyla Kullanılmıştır.Lütfen COTECH Kodlarını Kullanınız.  
Original codes used for reference only.Please use COTECH codes for orders.

00



01



02



03



04



Silindir Kapak  
Cylinder Head  
Zylinderkopf  
Joint de culasse

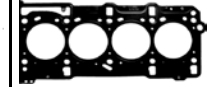

Ltr	MODEL	PS/KW	ENGINE/MOTOR		
0,75 747	4 CYL ø54,5 R 4 04/62-->	27 PS / 20 KW 20 PS / 15 KW	680 701 680 702	60106001 7701460365	<p><b>60106005</b> 7700724333 1,20mm</p> <p><b>60106006</b> 7700724333 1,80mm ø59,7</p>
0,85 845	4 CYL ø58 RODEO 4 10/62--> RODEO 6 4 5	37 PS / 27 KW 26 PS / 19 KW	B1B 707 800 800 01 800 02 800 05 800 705 800 710 839 839 06 839 07 839 701 839 706 839 707	60106001 7701460365	<p><b>60106005</b> 7700724333 1,20mm</p> <p><b>60106006</b> 7700724333 1,80mm ø59,7</p>
0,85 852	4 CYL ø61,4 R 4 01/72-->12/85 F 4	29 PS / 21 KW	813,02	60154002 77 01 453 078	<p><b>60108005</b> 77 00 680 688 1,20mm</p> <p><b>60108006</b> 77 00 680 688 1,80mm ø72</p>
0,85 852	4 CYL ø61,4 R 4 01/76-->12/76 F 4	29 PS / 21 KW	813,02	60108002 77 01 459 391	<p><b>60108005</b> 77 00 680 688 1,20mm</p> <p><b>60108006</b> 77 00 680 688 1,80mm ø72</p>

▲ : İçerikte Bulunmamaktadır...

▲ : Not included in the set

▲ : Non inclus dans la pochette

00: Motor Takım Keçesiz ve Subap Lastiksiz











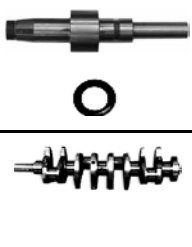
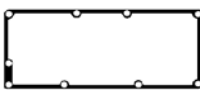



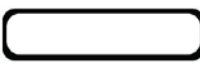

00: Gasket Set Without oil seals Without Valve Stem Seal

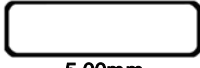
01: Motor Takım Keçesiz - Subap Lastikli

01: Gasket set With Valve Stem Seal Without Oil Seals

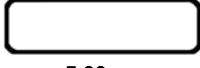
02: Motor Full Takım Keçeli ve Subap Lastikli

02: Gasket Full Set With oil seals and Valve Stem Seals

Subap Kapak Valve Cover Gasket Zylinderkopfhaube Couvre-culbut.	Karter Oil Pan Ölwanne Carter d'huile	Emme Manifold Intake Manifold Ansaug Admission	Egzoz Manifold Exhaust Manifold Auspuffkrümmer Collecteur D'echappement	Eksoz Boğaz Exhaust Pipe Auspuff Kehle	Supap Keçesi Valve Stem Seal Ventilschaft Queue de soupape	
						
<b>60106034</b> 05 55 565 700	<b>60106265</b> 980656900	<b>60106020 (x2)</b> 77 00 522 372				
						
<b>60106034</b> 05 55 565 700	<b>60106265</b> 980656900	<b>60106020 (x2)</b> 77 00 522 372				
						<b>21208003</b> 30x42x7 RD
5,00mm <b>60101525</b> 77 00 723 967	<b>60101265</b> 77 01 453 950	<b>60101020</b> 77 00 559 702				<b>21201066</b> 70x90x10 LD
						<b>21208003</b> 30x42x7 RD
5,00mm <b>60101525</b> 77 00 723 967	<b>60101265</b> 77 01 453 950	<b>60101020</b> 77 00 559 702				<b>21201034</b> 80x100x13 LD

■ : Delik - Çentik

■ : Hole - Notch

■ : Trou - Entaille

NOT: Katalogdaki Orjinal Kodlar Referans Amacıyla Kullanılmıştır.Lütfen COTECH Kodlarını Kullanınız.  
Original codes used for reference only.Please use COTECH codes for orders.

00



Silindir Kapak  
Cylinder Head  
Zylinderkopf  
Joint de culasse

01



02



03



04



Ltr	MODEL	PS/KW	ENGINE/MOTOR		
1.0 956	4 CYL ø65- ø69 R 5 R 6 01/72-->12/75	44 PS / 32 KW 45 PS / 33 KW	689 710	60154002 77 01 453 078	<p><b>60108005</b> 77 00 680 688 1,20mm</p> <p><b>60108006</b> 77 00 680 688 1,80mm ø72</p>
1.0 956	4 CYL ø65 R 5 01/72-->12/85	44 PS / 32 KW	689 710	60108002 77 01 459 391	<p><b>60108005</b> 77 00 680 688 1,20mm</p> <p><b>60108006</b> 77 00 680 688 1,80mm ø72</p>
1.0 956	4 CYL ø65 SUPER 5 RAPID SUPERCINGO EXPRESS 10/84-->	42 PS / 31 KW 33 PS / 24 KW	C1C C1C 700 C1C 706 C1C 708 C1C 754	60157002 77 01 462 215 77 01 465 261	<p><b>60108005</b> 77 00 680 688 1,20mm</p> <p><b>60108006</b> 77 00 680 688 1,80mm ø72</p>
1.0 998	4 CYL ø69 LOGAN FLEX 16V ( DOCH ) 2007-->	75 PS / 55 KW 78 PS / 58 KW	D4DHIFLEX	60108703 77 01 475 822	<p><b>60108605</b> 8200062273 MLS ø70</p>
1.0 999	4 CYL ø69 CLIO KANGOO TWINGO 1999-->	59 PS / 43 KW	D7D		<p><b>60108805</b> 77 00 864 736 1,40mm ø70,2</p>

▲ : İçerikte Bulunmamaktadır...

▲ : Not included in the set

▲ : Non inclus dans la pochette

00: Motor Takım Keçesiz ve Subap Lastiksiz











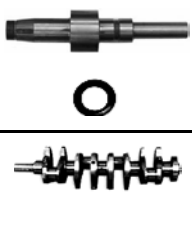
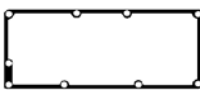







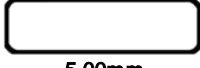

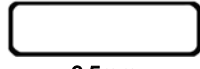

00: Gasket Set Without oil seals Without Valve Stem Seal

01: Motor Takım Keçesiz - Subap Lastikli

01: Gasket set With Valve Stem Seal Without Oil Seals

02: Motor Full Takım Keçeli ve Subap Lastikli

02: Gasket Full Set With oil seals and Valve Stem Seals

Subap Kapak Valve Cover Gasket Zylinderkopfhaube Couvre-culbut.	Karter Oil Pan Ölwanne Carter d'huile	Emme Manifold Intake Manifold Ansaug Admission	Egzoz Manifold Exhaust Manifold Auspuffkrümmer Collecteur D'echappement	Eksoz Boğaz Exhaust Pipe Auspuff Kehle	Supap Keçesi Valve Stem Seal Ventilschaft Queue de soupape	
						
5,00mm <b>60101525</b> 77 00 723 967	 <b>60101265</b> 77 01 453 950	 <b>60101020</b> 77 00 559 702			▲	<b>21208003</b> 30x42x7 RD
						<b>21201066</b> 70x90x10 LD
					▲	<b>21208003</b> 30x42x7 RD
5,00mm <b>60101525</b> 77 00 723 967	 <b>60101265</b> 77 01 453 950	 <b>60101020</b> 77 00 559 702				<b>21201034</b> 80x100x13 LD
						<b>21208067</b> 35x50x10 RD
6,5mm <b>60102525</b> 77 01 348 574	 <b>60102268x4</b> 77 00 564 813	 <b>60103020</b> 77 00 855 962			<b>60116026x8</b> 77 00 736 465 7x9,8/13.2x10	<b>21201034</b> 80x100x13 LD
						<b>21204701</b> 28x47x8 RD
<b>60108725</b> 77 01 059 314		<b>60108618</b> 77 01 473 007	<b>60108621</b> 77 00 115 971		<b>60108726x16</b> 82 00 171 215 5,5x8,3x11,5x8	

■ : Delik - Çentik

■ : Hole - Notch

■ : Trou - Entaille

NOT: Katalogdaki Orijinal Kodlar Referans Amacıyla Kullanılmıştır.Lütfen COTECH Kodlarını Kullanınız.  
Original codes used for reference only.Please use COTECH codes for orders.

00



Silindir Kapak

Cylinder Head

01



Zylinderkopf

02



Joint de culasse

03



04



Ltr	MODEL	PS/KW	ENGINE/MOTOR		
1,0 999	4 CYL ø69 CLIO 16V 2000--> KANGOO 16V 2003--> ( DOCH )	60 PS / 44 KW	D4D 700 D4D 720	60108603 77 01 473 003	 60108605 8200062273 MLS ø70
1,1 1108	4 CYL ø70 R 8 05/66-->10/72 R 10	45 PS / 33 KW	689		 60108005 77 00 680 688 1,20mm 60108006 77 00 680 688 1,80mm ø72
1,1 1108	4 CYL ø70 R 6 1972-->1975 RODEO R4 F6 R7		688	60154002 77 01 453 078	 60108005 77 00 680 688 1,20mm 60108006 77 00 680 688 1,80mm ø72
1,1 1108	4 CYL ø70 RODEO 5 08/70--> RODEO 6 R 4 R 5 R 6	56 PS / 41 KW 34 PS / 25 KW	688 688 02 688 711 688 712 688 713 688.10 C1E / 688 C1E 714 C1E 718 C1E 719	60108002 77 01 459 391	 60108005 77 00 680 688 1,20mm 60108006 77 00 680 688 1,80mm ø72
1,2 1149	4 CYL ø69 CLIO 16V 2000--> KANGOO 16V SANDERO 16V 2009--> ( DOCH )	75 PS / 55 KW	D4D 700 D4D 712 D4D	60108603 77 01 473 003	 60108605 8200062273 MLS ø70

▲ : İçerikte Bulunmamaktadır...

▲ : Not included in the set

▲ : Non inclus dans la pochette

00: Motor Takım Keçesiz ve Subap Lastiksiz











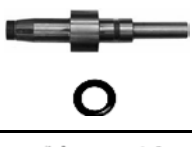
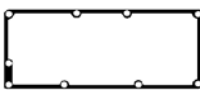





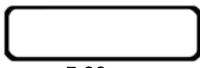

00: Gasket Set Without oil seals Without Valve Stem Seal

01: Motor Takım Keçesiz - Subap Lastikli

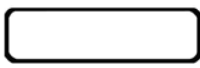
01: Gasket set With Valve Stem Seal Without Oil Seals

02: Motor Full Takım Keçeli ve Subap Lastikli

02: Gasket Full Set With oil seals and Valve Stem Seals

Subap Kapak Valve Cover Gasket Zylinderkopfhaube Couvre-culbut.	Karter Oil Pan Ölwanne Carter d'huile	Emme Manifold Intake Manifold Ansaug Admission	Egzoz Manifold Exhaust Manifold Auspuffkrümmer Collecteur D'echappement	Eksoz Boğaz Exhaust Pipe Auspuff Kehle	Supap Keçesi Valve Stem Seal Ventilschaft Queue de soupape	
						
 <b>60108625</b> 77 01 049 888		 <b>60108618</b> 77 01 473 007	 <b>60108621</b> 77 00 115 971		 <b>60108626x16</b> 5,5x11x23x15,7	<b>21204701</b> 28x47x8 RD
 5,00mm <b>60101525</b> 77 00 723 967	 <b>60101265</b> 77 01 453 950	 <b>60101020</b> 77 00 559 702				<b>21208003</b> 30x42x7 RD
					▲	<b>21201066</b> 70x90x10 LD
 5,00mm <b>60101525</b> 77 00 723 967	 <b>60101265</b> 77 01 453 950	 <b>60101020</b> 77 00 559 702				<b>21208003</b> 30x42x7 RD
					▲	<b>21201034</b> 80x100x13 LD
 <b>60108625</b> 77 01 049 888		 <b>60108618</b> 77 01 473 007	 <b>60108621</b> 77 00 115 971		 <b>60108626x16</b> 5,5x11x23x15,7	<b>21204701</b> 28x47x8 RD

■ : Delik - Çentik

■ : Hole - Notch

■ : Trou - Entaille

NOT: Katalogdaki Orijinal Kodlar Referans Amacıyla Kullanılmıştır.Lütfen COTECH Kodlarını Kullanınız.  
Original codes used for reference only.Please use COTECH codes for orders.

00



Silindir Kapak

Cylinder Head

01



Zylinderkopf

02



Joint de culasse

03



04



Ltr	MODEL	PS/KW	ENGINE/MOTOR		
1,1 1108	4 CYL ø70 CLIO RAPID SUPER 5 11 19 9	09/81-->09/98 49 PS / 36 KW 45 PS / 33 KW	C1E 700 C1E 715 C1E 720 C1E 750 C1E 752 C1E 754 C1E 756 C1E 760 C1E 762 C1E 792	60157002 77 01 462 215 77 01 465 261	 60108005 77 00 680 688 1,20mm 60108006 77 00 680 688 1,80mm ø72
1,2 1149	4 CYL ø69 TWINGO 16V CLIO 16V KANGOO 16V THALIA	01/01--> 75 PS / 55 KW 06/01--> 75 PS / 55 KW	D4F 702 D4F 704 D4F 706 D4F 712 D4F 714 D4F 716	60108603 77 01 473 003	 60108605 8200062273 MLS ø70
1,2 1149	4 CYL ø69 CLIO CLIO 16V MODUS MODUS 16V TWINGO TWINGO 16V	08/04--> 76 PS / 56 KW 60 PS / 44 KW	D4F 708 D4F 722 D4F 728 D4F 730 D4F 740 D4F 772	60108703 77 01 475 822	 60108605 8200062273 MLS ø70
1,2 1149	4 CYL ø69 CLIO CLIO 16V MODUS	12/04--> 78 PS / 58 KW 78 PS / 57 KW	D4F 764	60108503 77 01 476 731	 60108605 8200062273 MLS ø70
1,2 1149	4 CYL ø69 CLIO KANGOO THALIA TWINGO	01/96--> 60 PS / 44 KW 54 PS / 40 KW	D7D 760 D7F 700 D7F 701 D7F 702 D7F 703 D7F 704 D7F 706 D7F 710 D7F 720 D7F 722 D7F 726 D7F 730 D7F 744 D7F 746		 60108805 77 00 864 736 1,40mm ø70,2

▲ : İçerikte Bulunmamaktadır...

▲ : Not included in the set

▲ : Non inclus dans la pochette

00: Motor Takım Keçesiz ve Subap Lastiksiz











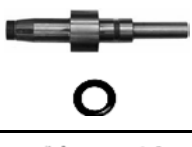
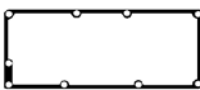











00: Gasket Set Without oil seals Without Valve Stem Seal

01: Motor Takım Keçesiz - Subap Lastikli

01: Gasket set With Valve Stem Seal Without Oil Seals

02: Motor Full Takım Keçeli ve Subap Lastikli

02: Gasket Full Set With oil seals and Valve Stem Seals

Subap Kapak Valve Cover Gasket Zylinderkopfhaube Couvre-culbut.	Karter Oil Pan Ölwanne Carter d'huile	Emme Manifold Intake Manifold Ansaug Admission	Egzoz Manifold Exhaust Manifold Auspuffkrümmer Collecteur D'echappement	Eksoz Boğaz Exhaust Pipe Auspuff Kehle	Supap Keçesi Valve Stem Seal Ventilschaft Queue de soupape	
						
 6,5mm <b>60102525</b> 77 01 348 574	 <b>60102268x4</b> 77 00 564 813	 <b>60103020</b> 77 00 855 962			 <b>60116026x8</b> 77 00 736 465 7x9,8/13.2x10	<b>21208067</b> 35x50x10 RD  <b>21201034</b> 80x100x13 LD
 <b>60108625</b> 77 01 049 888		 <b>60108618</b> 77 01 473 007	 <b>60108621</b> 77 00 115 971		 <b>60108626x16</b> 5,5x11x23x15,7	<b>21204701</b> 28x47x8 RD
 <b>60108725</b> 77 01 059 314		 <b>60108618</b> 77 01 473 007	 <b>60108621</b> 77 00 115 971		 <b>60108726x16</b> 82 00 171 215 5,5x8,3x11,5x8	<b>21204701</b> 28x47x8 RD
 <b>60108725</b> 77 01 059 314		 <b>60108618</b> 77 01 473 007	 <b>60108621</b> 77 00 115 971		 <b>60108726x16</b> 82 00 171 215 5,5x8,3x11,5x8	<b>21204025</b> 35x47x7 RD

■ : Delik - Çentik

■ : Hole - Notch

■ : Trou - Entaille

NOT: Katalogdaki Orijinal Kodlar Referans Amacıyla Kullanılmıştır.Lütfen COTECH Kodlarını Kullanınız.  
Original codes used for reference only.Please use COTECH codes for orders.

00



01



02



03



04



Silindir Kapak  
Cylinder Head  
Zylinderkopf  
Joint de culasse



Ltr	MODEL	PS/KW	ENGINE/MOTOR		
1,2 1149	<b>4 CYL ø69</b> KANGOO TWINGO 07/98-->07/01 03/07-->	60 PS / 44 KW 58 PS / 43 KW	D7F 764 D7F 800		 <b>60108805</b> 77 00 864 736 1,40mm <b>ø70,2</b>
1,2 1171	<b>4 CYL ø75,8</b> CLIO RAPID 05/90-->	65 PS / 44 KW 54 PS / 40 KW	E5F 710 E5F 716 E7F 700 E7F 704 E7F 706 E7F 708 E7F 730 E7F 750	<b>60116002</b> Motor Full Takım Gasket Full Set  <b>60116003</b> 77 01 468 142  <b>60116004</b> Alt Takım Conversion Set	 <b>60116005</b> 77 00 273 786 1,40mm  <b>60116006</b> 77 00 739 302 1,80mm <b>ø77</b>
1,2 1237	<b>4 CYL ø71,5</b> RAPID SUPER 5 11 19 9 10/84-->12/96	60 PS / 44 KW 54 PS / 40 KW	C1G C1G 700 C1G 702 C1G 710 C1G 720 C1G 722 C1G 726 C1G 730	<b>▲ 60103001</b> Motor Takım Gasket Set  <b>60103002</b> Motor Full Takım Gasket Full Set  <b>60103003</b> 77 01 462 216	 <b>60102005</b> 77 00 680 689 1,20mm <b>60102006</b> 77 00 680 689 1,40mm <b>60102009</b> 77 00 680 689 1,80mm <b>ø77</b>
1,3 1289	<b>4 CYL ø73</b> 12 12 TS ESTAFETTE RODEO 5 5 08/69-->	68 PS / 49 KW 39 PS / 29 KW	810 01 810 02 810 2/97 810 06 810 719 810 725 810 726 810 729 810 96 810 97	<b>▲ 60101001</b> Motor Takım Gasket Set  <b>60101002</b> 77 01 452 153	 <b>60101005</b> 77 00 576 242 1,20mm  <b>60101006</b> 77 00 576 242 1,80mm <b>ø74,3</b>

▲ : İçerikte Bulunmamaktadır...

▲ : Not included in the set

▲ : Non inclus dans la pochette

00: Motor Takım Keçesiz ve Subap Lastiksiz











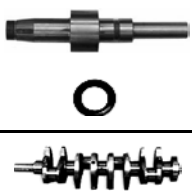
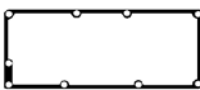







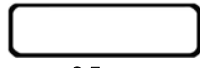

00: Gasket Set Without oil seals Without Valve Stem Seal

01: Motor Takım Keçesiz - Subap Lastikli

01: Gasket set With Valve Stem Seal Without Oil Seals

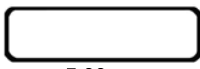
02: Motor Full Takım Keçeli ve Subap Lastikli

02: Gasket Full Set With oil seals and Valve Stem Seals

Subap Kapak Valve Cover Gasket Zylinderkopfhaube Couvre-culbut.	Karter Oil Pan Ölwanne Carter d'huile	Emme Manifold Intake Manifold Ansaug Admission	Egzoz Manifold Exhaust Manifold Auspuffkrümmer Collecteur D'echappement	Eksoz Boğaz Exhaust Pipe Auspuff Kehle	Supap Keçesi Valve Stem Seal Ventilschaft Queue de soupape	
						
 <b>60116527</b> 77 00 739 165	 <b>60116265</b> 77 00 739 392	 <b>60116021</b> 77 00 746 591	 <b>60116020</b> 77 00 746 591		 <b>60116026x8</b> 77 00 736 465 <b>7x9,8/13.2x10</b>	<b>21204004</b> 30x42x7 RD
						<b>21208001</b> 35x47x7 RD
						<b>21208012</b> 80x100x8 LD
 <b>6,5mm</b> <b>60102525</b> 77 01 348 574	 <b>60102265</b> 77 01 457 561	 <b>60103020</b> 77 00 855 962			 <b>▲ 60103027x8</b> 77 00 658 325 <b>7x10,8x13x9,8</b>	<b>▲ 21208067</b> 35x50x10 RD <b>▲ 21201034</b> 80x100x13 LD
 <b>5,00mm</b> <b>60101525</b> 77 00 723 967	 <b>60101265</b> 77 01 453 950	 <b>60101020</b> 77 00 559 702		 <b>60101017</b> 77 00 502 706	<b>▲</b>	<b>21201011</b> 35x50x8 RD <b>21201031</b> 70x90x10 LD

■ : Delik - Çentik

■ : Hole - Notch

■ : Trou - Entaille

NOT: Katalogdaki Orijinal Kodlar Referans Amacıyla Kullanılmıştır.Lütfen COTECH Kodlarını Kullanınız.  
Original codes used for reference only.Please use COTECH codes for orders.

00



Silindir Kapak  
Cylinder Head

01



Zylinderkopf

02



Joint de culasse

03



04

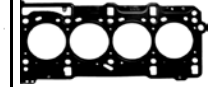

Ltr	MODEL	PS/KW	ENGINE/MOTOR		
1,3 1289	<b>4 CYL ø73</b> R 5 R 5 Automatic RODEO 09/75-->09/84	64 PS / 47 KW 54 PS / 40 KW 45 PS / 33 KW	810 810.19 810 719 810 725 810 729	<b>60123002</b> 77 01 457 752	 <b>60101005</b> 77 00 576 242 1,20mm <b>60101006</b> 77 00 576 242 1,80mm <b>ø74,3</b>
1,3 1289	<b>4 CYL ø73</b> R 12 R 15 ESTAFETTE 07/75-->04/80	54 PS / 40 KW 60 PS / 44 KW	810.01 810.02 810.03 810.05	<b>60101102</b> 77 01 451 749	 <b>60101005</b> 77 00 576 242 1,20mm <b>60101006</b> 77 00 576 242 1,80mm <b>ø74,3</b>
1,4 1390	<b>4 CYL ø75,8</b> CLIO RAPID 19 01/88-->	80 PS / 59 KW 58 PS / 43 KW	E6J 700 E6J 701 E6J 706 E6J 712 E6J 713 E6J 718 E6J 734 E6J 738 E6J 760 E7J 601 E7J 700 E7J 706 E7J 710 E7J 711 E7J 718 E7J 719 E7J 720 E7J 724 E7J 726 E7J 728 E7J 742 E7J 745 E7J 754 E7J 756 E7J 757 E7J 773	<b>60116002</b> Motor Full Takım Gasket Full Set <b>60116003</b> 77 01 468 142 <b>60116004</b> Alt Takım Conversion Set	 <b>60116005</b> 77 00 273 786 1,40mm <b>60116006</b> 77 00 739 302 1,80mm <b>ø77</b>

▲ : İçerikte Bulunmamaktadır...

▲ : Not included in the set

▲ : Non inclus dans la pochette

00: Motor Takım Keçesiz ve Subap Lastiksiz











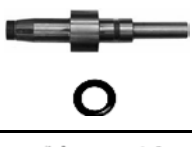
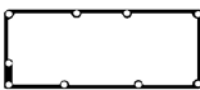







00: Gasket Set Without oil seals Without Valve Stem Seal

01: Motor Takım Keçesiz - Subap Lastikli

01: Gasket set With Valve Stem Seal Without Oil Seals

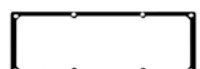
02: Motor Full Takım Keçeli ve Subap Lastikli

02: Gasket Full Set With oil seals and Valve Stem Seals

Subap Kapak Valve Cover Gasket Zylinderkopfhaube Couvre-culbut.	Karter Oil Pan Ölwanne Carter d'huile	Emme Manifold Intake Manifold Ansaug Admission	Egzoz Manifold Exhaust Manifold Auspuffkrümmer Collecteur D'echappement	Eksoz Boğaz Exhaust Pipe Auspuff Kehle	Supap Keçesi Valve Stem Seal Ventilschaft Queue de soupape	
						
 5,00mm <b>60101525</b> 77 00 723 967	 <b>60102265</b> 77 01 457 561	 <b>60101020</b> 77 00 559 702			▲	<b>21204004</b> 30x42x7 RD <b>21201031</b> 70x90x10 LD
 5,00mm <b>60101525</b> 77 00 723 967	 <b>60101265</b> 77 01 453 950	 <b>60101020</b> 77 00 559 702		 <b>60101017</b> 77 00 502 706	▲	<b>21201011</b> 35x50x8 RD <b>21201034</b> 80x100x13 LD
 <b>60116527</b> 77 00 739 165	 <b>60116265</b> 77 00 739 392	 <b>60116021</b> 77 00 746 591	 <b>60116020</b> 77 00 746 591		 <b>60116026x8</b> 77 00 736 465 7x9,8/13.2x10	<b>21204004</b> 30x42x7 RD <b>21208001</b> 35x47x7 RD <b>21208012</b> 80x100x8 LD

■ : Delik - Çentik

■ : Hole - Notch

■ : Trou - Entaille

NOT: Katalogdaki Orijinal Kodlar Referans Amacıyla Kullanılmıştır.Lütfen COTECH Kodlarını Kullanınız.  
Original codes used for reference only.Please use COTECH codes for orders.

00



Silindir Kapak

Cylinder Head

01



Zylinderkopf

02



Joint de culasse

03



04

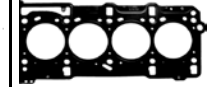

Ltr	MODEL	PS/KW	ENGINE/MOTOR		
1,4 1390	<b>4 CYL ø75,8</b> CLIO 03/98--> CLIO 10/98-->05/05 KANGOO 09/97--> MEGANE 03/99--> MEGANE 11/95-->06/97 SCENIC 11/95-->06/97	75 PS / 55 KW 75 PS / 55 KW 75 PS / 55 KW 75 PS / 55 KW 75 PS / 55 KW 75 PS / 55 KW	E7J 780 E7J 635 - E7J 635 E7J 634 - E7J 780 E7J 626 - E7J 634 E7J 624 - E7J 764 E7J 624 - E7J 764	<b>60116102</b> Motor Full Takım Gasket Full Set  <b>60116103</b> 77 01 468 709  <b>60116104</b> Alt Takım Conversion Set	 <b>60116005</b> 77 00 273 786 1,40mm  <b>60116006</b> 77 00 739 302 1,80mm <b>ø77</b>
1,4 1390	<b>4 CYL ø79,5</b> CLIO 16V 03/99--> MEGANE 16V MEGANE Grandtour 16V MODUS SCÉNIC 16V THALIA 16V  MEGANE 11/02--> MEGANE 16V SCÉNIC	98 PS / 72 KW 95 PS / 70 KW  98 PS / 72 KW 82 PS / 60 KW	K4J K4J 700 K4J 710 K4J 711 K4J 712 K4J 713 K4J 714 K4J 715 K4J 750 K4J 770 K4J 780 K4J 730 K4J 732 K4J 740	<b>62457202</b> Motor Full Takım Gasket Full Set  <b>62457203</b> 77 01 471 886  <b>62457204</b> Alt Takım Conversion Set	 <b>62457205</b> 77 00 112 739 <b>MLS</b> <b>ø80,5</b>
1,4 1390	<b>4 CYL ø79,5</b> SCENIC16V 06/03--> MEGANE 16V 08/03--> MODUS 16V 06/05--> CLIO 16V 06/05-->	98 PS / 72 KW	K4J 740 K7J 780	<b>62456502</b> Motor Takım Gasket Full Set  <b>62457203</b> 77 01 471 886  <b>62457404</b> Alt Takım Conversion Set	 <b>62457205</b> 77 00 112 739 <b>MLS</b> <b>ø80,5</b>

▲ : İçerikte Bulunmamaktadır...

▲ : Not included in the set

▲ : Non inclus dans la pochette

00: Motor Takım Keçesiz ve Subap Lastiksiz











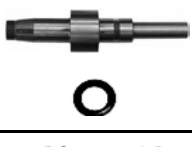
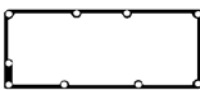











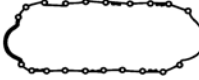

00: Gasket Set Without oil seals Without Valve Stem Seal

01: Motor Takım Keçesiz - Subap Lastikli

01: Gasket set With Valve Stem Seal Without Oil Seals

02: Motor Full Takım Keçeli ve Subap Lastikli

02: Gasket Full Set With oil seals and Valve Stem Seals

Subap Kapak Valve Cover Gasket Zylinderkopfhaube Couvre-culbut.	Karter Oil Pan Ölwanne Carter d'huile	Emme Manifold Intake Manifold Ansaug Admission	Egzoz Manifold Exhaust Manifold Auspuffkrümmer Collecteur D'echappement	Eksoz Boğaz Exhaust Pipe Auspuff Kehle	Supap Keçesi Valve Stem Seal Ventilschaft Queue de soupape	
						
 <b>60116527</b> 77 00 739 165	 ø7 <b>60116165</b>	 <b>60108918x4</b> 77 01 471 932	 <b>60149020</b> 77 00 867 360		 <b>60116026x8</b> 77 00 736 465 7x9,8/13.2x10	<b>21204004</b> 30x42x7 RD
		 <b>60149018x4</b> 77 01 471 816				<b>21208001</b> 35x47x7 RD
		 <b>60116019</b> 77 00 273 827				<b>21208012</b> 80x100x8 LD
		 <b>60116021</b> 77 00 746 591				
	 <b>62457265</b> 77 00 103 687	 <b>62457218x4</b> 82 00 052 312	 <b>62457221</b> 77 00 107 181		 <b>62457244x16</b> 77 00 103 938 5,5x11x28x16,4	<b>21204024x2</b> 28x42x5 RD
		 <b>62457219</b> 77 00 105 852				<b>21204005</b> 35x47x7 RD
						<b>21204009</b> 80x100x8 LD
	 <b>62457065</b> 82 00 379 654	 <b>62457218x4</b> 82 00 052 312	 <b>62457221</b> 77 00 107 181		 <b>62457244x16</b> 77 00 103 938 5,5x11x28x16,4	<b>21204024x2</b> 28x42x5 RD
		 <b>62457219</b> 77 00 105 852				<b>21204005</b> 35x47x7 RD
						<b>21204009</b> 80x100x8 LD

■ : Delik - Çentik

■ : Hole - Notch

■ : Trou - Entaille

NOT: Katalogdaki Orjinal Kodlar Referans Amacıyla Kullanılmıştır.Lütfen COTECH Kodlarını Kullanınız.  
Original codes used for reference only.Please use COTECH codes for orders.

00



01



02



03



04



Silindir Kapak  
Cylinder Head  
Zylinderkopf  
Joint de culasse

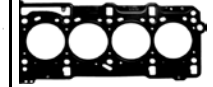

Ltr	MODEL	PS/KW	ENGINE/MOTOR		
1,4 1390	4 CYL ø79,5 LOGAN 09/04-->	75 PS / 55 KW	K7J 710	60108902 Motor Full Takım Gasket Full Set	<p><b>60108905</b> 82 00 296 969 1,20mm FIBER / FIBRE <b>60108906</b> 82 00 296 969 MLS ø80,5</p>
1,4 1390	4 CYL ø79,5 SYMBOL THALIA 08/08--> CLIO 08/97--> KANGOO	75 PS / 55 KW 75 PS / 55 KW	K7J 700 K7J 700 K7J 700 K7J 701	60149002 Motor Full Takım Gasket Full Set	<p><b>60149005</b> 77 00 866 683 1,40mm <b>60149006</b> 77 00 866 683 1,60mm ø80</p>
1,4 1397	4 CYL ø76 R 12 TS 01/76-->12/80 R 5 TX	63 PS / 46 KW 59 PS / 43 KW	847.05 847.06 847.07	60102002 77 01 458 695	<p><b>60102005</b> 77 00 680 689 1,20mm <b>60102006</b> 77 00 680 689 1,40mm <b>60102009</b> 77 00 680 689 1,80mm ø77</p>

▲ : İçerikte Bulunmamaktadır...

▲ : Not included in the set

▲ : Non inclus dans la pochette

00: Motor Takım Keçesiz ve Subap Lastiksiz











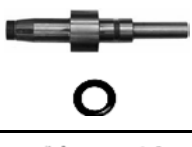
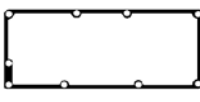





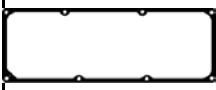
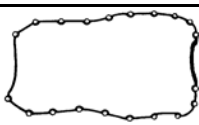

00: Gasket Set Without oil seals Without Valve Stem Seal

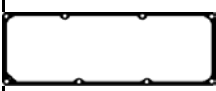
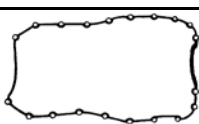
01: Motor Takım Keçesiz - Subap Lastikli

01: Gasket set With Valve Stem Seal Without Oil Seals

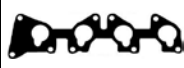
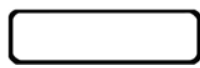
02: Motor Full Takım Keçeli ve Subap Lastikli

02: Gasket Full Set With oil seals and Valve Stem Seals

Subap Kapak Valve Cover Gasket Zylinderkopfhaube Couvre-culbut.	Karter Oil Pan Ölwanne Carter d'huile	Emme Manifold Intake Manifold Ansaug Admission	Egzoz Manifold Exhaust Manifold Auspuffkrümmer Collecteur D'echappement	Eksoz Boğaz Exhaust Pipe Auspuff Kehle	Supap Keçesi Valve Stem Seal Ventilschaft Queue de soupape	
						
						<b>21208003</b> 30x42x7 RD
<b>60116527</b> 77 01 471 719	<b>62457165</b> 77 00 273 486	<b>60108918x4</b> 77 01 471 932	<b>60108921</b> 8200191371		<b>60116026x8</b> 77 00 103 872 <b>7x9,8/13.2x10</b>	<b>21208001</b> 35x47x7 RD
						<b>21208003</b> 30x42x7 RD
<b>60116527</b> 77 01 471 719	<b>62457165</b> 77 00 273 486	<b>60108918x4</b> 77 01 471 932	<b>60149020</b> 77 00 867 360		<b>60116026x8</b> 77 00 103 872 <b>7x9,8/13.2x10</b>	<b>21208001</b> 35x47x7 RD
						<b>21208012</b> 80x100x8 LD
		<b>60149018x4</b> 77 01 471 816				
						
		<b>60149019</b> 77 00 865 764				
						<b>▲21201011</b> 35x50x8 RD
<b>6,5mm</b> <b>60102525</b> 77 01 348 574	<b>60102265</b> 77 01 457 561	<b>60101020</b> 77 00 559 702		<b>60101017</b> 77 00 502 706		<b>▲21201034</b> 80x100x13 LD

■ : Delik - Çentik

■ : Hole - Notch

■ : Trou - Entaille

NOT: Katalogdaki Orijinal Kodlar Referans Amacıyla Kullanılmıştır.Lütfen COTECH Kodlarını Kullanınız.  
Original codes used for reference only.Please use COTECH codes for orders.

00



01



02



03



04



Silindir Kapak  
Cylinder Head  
Zylinderkopf  
Joint de culasse

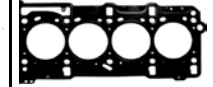

Ltr	MODEL	PS/KW	ENGINE/MOTOR			
1,4 1397	<b>4 CYL ø76</b> R 18 TRAFIC FUEGO	03/80-->04/89 03/80-->06/91 02/80-->10/85	64 PS / 47 KW 48 PS / 35 KW 64 PS / 47 KW	847.20 / C1J 847.700 847.701 C1J.700 847.720	<b>60125002</b> 77 01 460 626	 <b>60102005</b> 77 00 680 689 1,20mm <b>60102006</b> 77 00 680 689 1,40mm <b>60102009</b> 77 00 680 689 1,80mm <b>ø77</b>
1,4 1397	<b>4 CYL ø76</b> R 9 R 11 R 12 R 19 R 21 SUPERCINGO SUPER 5 RAPID	08/76-->	72 PS / 53 KW 58 PS / 43 KW	C1J 715 C2J 717 C2J 718 C2J 720 C2J 730 C2J 756 C2J 766 C2J 768 C3J 700 C3J 702 C3J 710 C3J 756 C3J 760 C3J 762	<b>▲ 60103001</b> Motor Takım Gasket Set  <b>60103002</b> Motor Full Takım Gasket Full Set  <b>60103003</b> 77 01 462 216	 <b>60102005</b> 77 00 680 689 1,20mm <b>60102006</b> 77 00 680 689 1,40mm <b>60102009</b> 77 00 680 689 1,80mm <b>ø77</b>
1,4 1397	<b>4 CYL ø76</b> R 9 R 11 R 12 R 19 R 21 SUPERCINGO SUPER 5 RAPID	08/76-->	72 PS / 53 KW 58 PS / 43 KW	C1J 715 C2J 717 C2J 718 C2J 720 C2J 730 C2J 756 C2J 766 C2J 768 C3J 700 C3J 702 C3J 710 C3J 756 C3J 760 C3J 762	<b>▲ 60103101</b> Motor Takım Gasket Set  <b>60103102</b> Motor Full Takım Gasket Full Set  <b>60103003</b> 77 01 462 216	 <b>60102005</b> 77 00 680 689 1,20mm <b>60102006</b> 77 00 680 689 1,40mm <b>60102009</b> 77 00 680 689 1,80mm <b>ø77</b>

▲ : İçerikte Bulunmamaktadır...

▲ : Not included in the set

▲ : Non inclus dans la pochette

00: Motor Takım Keçesiz ve Subap Lastiksiz











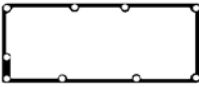



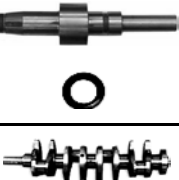
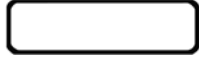

00: Gasket Set Without oil seals Without Valve Stem Seal

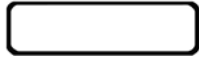
01: Motor Takım Keçesiz - Subap Lastikli

01: Gasket set With Valve Stem Seal Without Oil Seals

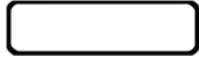
02: Motor Full Takım Keçeli ve Subap Lastikli

02: Gasket Full Set With oil seals and Valve Stem Seals

<p>Subap Kapak Valve Cover Gasket Zylinderkopfhaube Couvre-culbut.</p> 	<p>Karter Oil Pan Ölwanne Carter d'huile</p> 	<p>Emme Manifold Intake Manifold Ansaug Admission</p> 	<p>Egzoz Manifold Exhaust Manifold Auspuffkrümmer Collecteur D'echappement</p> 	<p>Eksoz Boğaz Exhaust Pipe Auspuff Kehle</p> 	<p>Supap Keçesi Valve Stem Seal Ventilschaft Queue de soupape</p> 	
 <p>6,5mm <b>60102525</b> 77 01 348 574</p>	 <p><b>60102265</b> 77 01 457 561</p>	 <p><b>60101020</b> 77 00 559 702</p>				<p><b>21208067</b> 35x50x10 RD</p> <p><b>21201034</b> 80x100x13 LD</p>
 <p>6,5mm <b>60102525</b> 77 01 348 574</p>	 <p><b>60102265</b> 77 01 457 561</p>	 <p><b>60103020</b> 77 00 855 962</p>			 <p>▲ <b>60103027x8</b> 77 00 658 325 7x10,8x13x9,8</p>	<p>▲ <b>21208067</b> 35x50x10 RD</p> <p>▲ <b>21201034</b> 80x100x13 LD</p>
 <p>6,5mm <b>60102525</b> 77 01 348 574</p>	 <p><b>60102268x4</b> 77 00 564 813</p>	 <p><b>60103020</b> 77 00 855 962</p>			 <p>▲ <b>60103027x8</b> 77 00 658 325 7x10,8x13x9,8</p>	<p>▲ <b>21208067</b> 35x50x10 RD</p> <p>▲ <b>21201034</b> 80x100x13 LD</p>

■ : Delik - Çentik

■ : Hole - Notch

■ : Trou - Entaille

NOT: Katalogdaki Orijinal Kodlar Referans Amacıyla Kullanılmıştır.Lütfen COTECH Kodlarını Kullanınız.  
Original codes used for reference only.Please use COTECH codes for orders.

00



Silindir Kapak

Cylinder Head

01



Zylinderkopf

02



Joint de culasse

03



04

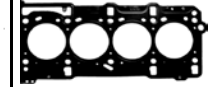

Ltr	MODEL	PS/KW	ENGINE/MOTOR		
1,4 1397	4 CYL ø76 SUPER 02/84-->08/90 SUPER 5 SUPER 5 Turbo 11 11 Turbo 9 Turbo	120 PS / 88 KW 105 PS / 77 KW	C1J 760 C1J 764 C1J 770 C1J 782 C1J 784 C1J 788	60107602 77 01 465 268	 60107605 77 00 733 041 1,80mm ø77
1,5 1461	4 CYL ø76 CLIO dCi 06/01--> CLIO DCI KANGOO DCI SCÉNIC DCI THALIA THALIA dCi THALIA DCI	82 PS / 60 KW 65 PS / 48 KW	K9K 700 K9K 702 K9K 704 K9K 710 K9K 722	62457102 Motor Full Takım Gasket Full Set 62457103 77 01 473 371 62457104 Motor Alt Takım Conversion Set	 62457105 82 00 071 111 0,60mm 62457106 82 00 071 111 0,82mm MLS ø77,5
1,5 1461	4 CYL ø76 CLIO 12/04--> CLIO dCi MODUS THALIA dCi TWINGO dCi CLIO dCi 11/03--> MEGANE DCI 11/02--> SCÉNIC DCI	82 PS / 60 KW 64 PS / 47 KW 82 PS / 60 KW 86 PS / 63 KW 82 PS / 60 KW	K9K 706 K9K 740 K9K 750 K9K 752 K9K 790 K9K 716 K9K 722	62456902 Motor Full Takım Gasket Full Set 62457003 77 01 476 729 62457104 Motor Alt Takım Conversion Set	 62457005 82 00 351 353 0,70mm 62457006 82 00 351 353 0,82mm MLS ø77,5
1,5 1461	4 CYL ø76 CLIO DCI 11/03--> GRAND SCÉNIC dCi GRAND SCÉNIC DCI MEGANE dCi MEGANE DCI SCÉNIC dCi SCÉNIC DCI	106 PS / 78 KW 100 PS / 74 KW	K9K 712 K9K 728	62457002 Motor Full Takım Gasket Full Set 62457003 77 01 476 729 62457004 Motor Alt Takım Conversion Set	 62457005 82 00 351 353 0,70mm 62457006 82 00 351 353 0,82mm MLS ø77,5

▲ : İçerikte Bulunmamaktadır...

▲ : Not included in the set

▲ : Non inclus dans la pochette

00: Motor Takım Keçesiz ve Subap Lastiksiz











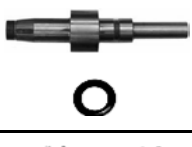
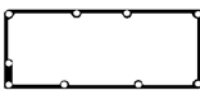







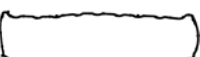

00: Gasket Set Without oil seals Without Valve Stem Seal

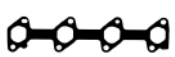
01: Motor Takım Keçesiz - Subap Lastikli

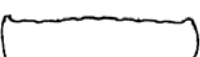
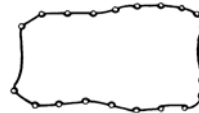
01: Gasket set With Valve Stem Seal Without Oil Seals

02: Motor Full Takım Keçeli ve Subap Lastikli

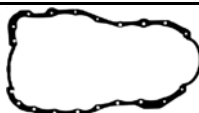
02: Gasket Full Set With oil seals and Valve Stem Seals

Subap Kapak Valve Cover Gasket Zylinderkopfhaube Couvre-culbut.	Karter Oil Pan Ölwanne Carter d'huile	Emme Manifold Intake Manifold Ansaug Admission	Egzoz Manifold Exhaust Manifold Auspuffkrümmer Collecteur D'echappement	Eksoz Boğaz Exhaust Pipe Auspuff Kehle	Supap Keçesi Valve Stem Seal Ventilschaft Queue de soupape	
						
 6,5mm <b>60102525</b> 77 01 348 574	 <b>60102267</b> 77 00 564 813	 <b>60103020</b> 77 00 855 962				<b>21208067</b> 35x50x10 RD  <b>21201034</b> 80x100x13 LD
 <b>62457125</b> 82 00 117 388	 <b>62457165</b> 77 00 273 486		 <b>62457121</b> 82 00 128 551		 <b>62457144x8</b> 77 00 109 840 <b>6x8,8x12,2x9,7</b>	<b>21204024</b> 28x42x5 RD  <b>21204025</b> 35x47x7 RD  <b>21204033</b> 80x100x9 LD
 <b>62457125</b> 82 00 117 388	 <b>62457165</b> 77 00 273 486		 <b>62457021</b> 82 00 414 346		 <b>62457144x8</b> 77 00 109 840 <b>6x8,8x12,2x9,7</b>	<b>21204024</b> 28x42x5 RD  <b>21204025</b> 35x47x7 RD  <b>21204033</b> 80x100x9 LD
 <b>62457125</b> 82 00 117 388	 <b>62457065</b> 82 00 379 654		 <b>62457021</b> 82 00 414 346		 <b>62457144x8</b> 77 00 109 840 <b>6x8,8x12,2x9,7</b>	<b>21204024</b> 28x42x5 RD  <b>21204025</b> 35x47x7 RD  <b>21204033</b> 80x100x9 LD











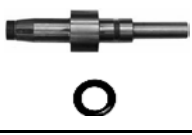
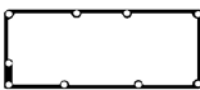



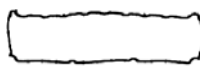
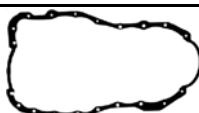

■ : Delik - Çentik

■ : Hole - Notch

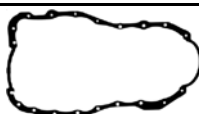
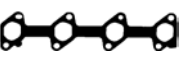
■ : Trou - Entaille

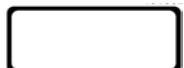
NOT: Katalogdaki Orijinal Kodlar Referans Amacıyla Kullanılmıştır.Lütfen COTECH Kodlarını Kullanınız.  
Original codes used for reference only.Please use COTECH codes for orders.

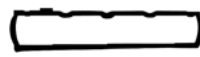
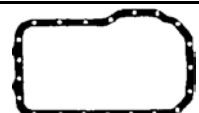

Subap Kapak Valve Cover Gasket Zylinderkopfhaube Couvre-culbut.	Karter Oil Pan Ölwanne Carter d'huile	Emme Manifold Intake Manifold Ansaug Admission	Egzoz Manifold Exhaust Manifold Auspuffkrümmer Collecteur D'echappement	Eksoz Boğaz Exhaust Pipe Auspuff Kehle	Supap Keçesi Valve Stem Seal Ventilschaft Queue de soupape	
						
 <b>62457125</b> 82 00 117 388	 <b>62457065</b> 82 00 379 654		 <b>62457021</b> 82 00 414 346		 <b>62457144x8</b> 77 00 109 840 <b>6x8,8x12,2x9,7</b>	<b>21204024</b> 28x42x5 RD
						<b>21204025</b> 35x47x7 RD
						<b>21204033</b> 80x100x9 LD
 <b>62457025</b> 77 01 066 400	 <b>62457065</b> 82 00 379 654		 <b>62457021</b> 82 00 414 346		 <b>62457144x8</b> 77 00 109 840 <b>6x8,8x12,2x9,7</b>	<b>21204024</b> 28x42x5 RD
						<b>21204025</b> 35x47x7 RD
						<b>21204033</b> 80x100x9 LD
 <b>60110525</b> 77 00 725 186	 <b>60110265</b> 7700710279	 <b>60109020</b> 77 00 635 407				<b>21201010</b> 32x45x8 RD
						<b>21201034</b> 80x100x13 LD
 <b>60104525</b> 77 00 719 666	 <b>60113265</b> 77 00 859 751	 <b>60113021</b> 77 00 103 849			 <b>60107027x8</b> 77 00 737 124 <b>8x10,8x14,2x10</b>	<b>21204002</b> 25x42x8 RD
						<b>21201027</b> 50x68x10 RD
						<b>21201038</b> 85x105x8 LD











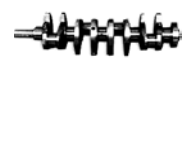
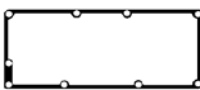







■ : Delik - Çentik

■ : Hole - Notch

■ : Trou - Entaille

NOT: Katalogdaki Orijinal Kodlar Referans Amacıyla Kullanılmıştır.Lütfen COTECH Kodlarını Kullanınız.  
Original codes used for reference only.Please use COTECH codes for orders.



Subap Kapak Valve Cover Gasket Zylinderkopfhaube Couvre-culbut.	Karter Oil Pan Ölwanne Carter d'huile	Emme Manifold Intake Manifold Ansaug Admission	Egzoz Manifold Exhaust Manifold Auspuffkrümmer Collecteur D'echappement	Eksoz Boğaz Exhaust Pipe Auspuff Kehle	Supap Keçesi Valve Stem Seal Ventilschaft Queue de soupape	 
						
	 <b>62457265</b> 77 00 103 687	 <b>62457218x4</b> 82 00 052 312  <b>62457219</b> 77 00 105 852	 <b>62457221</b> 77 00 107 181		 <b>62457244x16</b> 77 00 103 938 <b>5,5x11x28x16,4</b>	<b>21204024x2</b> 28x42x5 RD <b>21204005</b> 35x47x7 RD <b>21204009</b> 80x100x8 LD
	 <b>62457265</b> 77 00 103 687	 <b>62457219</b> 77 00 105 852  <b>62457418x4</b> 82 00 275 057	 <b>62457221</b> 77 00 107 181  <b>62457222</b> 82 00 365 915		 <b>62457244x16</b> 77 00 103 938 <b>5,5x11x28x16,4</b>	<b>21208071</b> 33x42x6 RD <b>21204024</b> 28x42x5 RD <b>21204005</b> 35x47x7 RD <b>21204009</b> 80x100x8 LD

■ : Delik - Çentik

■ : Hole - Notch

■ : Trou - Entaille

NOT: Katalogdaki Orijinal Kodlar Referans Amacıyla Kullanılmıştır.Lütfen COTECH Kodlarını Kullanınız.  
Original codes used for reference only.Please use COTECH codes for orders.

00



Silindir Kapak  
Cylinder Head

01



Zylinderkopf

02



Joint de culasse

03



04

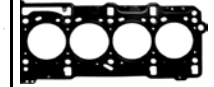

Ltr	MODEL	PS/KW	ENGINE/MOTOR		
1,6 1598	<b>4 CYL ø79,5</b> MEGANE 01/96-->03/99 LOGAN KANGOO MEGANE Grandtour MEGANE Scenic THALIA	90 PS / 66 KW 75 PS / 55 KW	K7M 702 K7M 703 K7M 710 K7M 720 K7M 746 K7M 790	<b>60149002</b> Motor Full Takım Gasket Full Set  <b>60149003</b> 77 01 468 710  <b>60149004</b> Alt Takım Conversion Set	 <b>60149005</b> 77 00 866 683 1,40mm  <b>60149006</b> 77 00 866 683 1,60mm <b>ø80</b>
1,6 1598	<b>4 CYL ø79,5</b> CLIO 09/98-->05/05 MEGANE	90 PS / 66 KW 87 PS / 64 KW	K7M 704 K7M 744 K7M 745	<b>60149102</b> Motor Full Takım Gasket Full Set  <b>60149103</b> Üst Takım Gasket Head Set  <b>60149004</b> Alt Takım Conversion Set	 <b>60149005</b> 77 00 866 683 1,40mm  <b>60149006</b> 77 00 866 683 1,60mm <b>ø80</b>
1,6 1598	<b>4 CYL ø79,5</b> GRAND SCÉNIC 06/05--> LOGAN MEGANE SCÉNIC	105 PS / 77 KW	K4M 690 K4M 788	<b>62456602</b> Motor Full Takım Gasket Full Set  <b>62456603</b> 77 01 471 886  <b>62457204</b> Alt Takım Conversion Set	 <b>62457205</b> 77 00 112 739 <b>MLS</b> <b>ø80,5</b>

▲ : İçerikte Bulunmamaktadır...

▲ : Not included in the set

▲ : Non inclus dans la pochette

00: Motor Takım Keçesiz ve Subap Lastiksiz











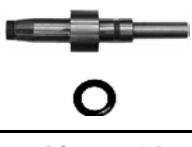
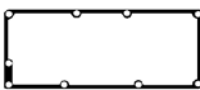







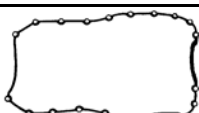

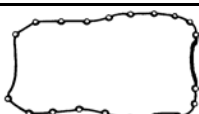

00: Gasket Set Without oil seals Without Valve Stem Seal

01: Motor Takım Keçesiz - Subap Lastikli

01: Gasket set With Valve Stem Seal Without Oil Seals

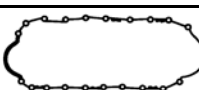
02: Motor Full Takım Keçeli ve Subap Lastikli

02: Gasket Full Set With oil seals and Valve Stem Seals

Subap Kapak Valve Cover Gasket Zylinderkopfhaube Couvre-culbut.	Karter Oil Pan Ölwanne Carter d'huile	Emme Manifold Intake Manifold Ansaug Admission	Egzoz Manifold Exhaust Manifold Auspuffkrümmer Collecteur D'echappement	Eksoz Boğaz Exhaust Pipe Auspuff Kehle	Supap Keçesi Valve Stem Seal Ventilschaft Queue de soupape	
						
		 <b>60108918x4</b> 77 01 471 932	 <b>60149020</b> 77 00 867 360		 <b>60116026x8</b> 77 00 103 872 7x9,8/13.2x10	<b>21208003</b> 30x42x7 RD
<b>60116527</b> 77 01 471 719	<b>62457165</b> 77 00 273 486	 <b>60149018x4</b> 77 01 471 816				<b>21208001</b> 35x47x7 RD
		 <b>60149019</b> 77 00 865 764				<b>21208012</b> 80x100x8 LD
		 <b>60116019</b> 77 00 273 827	 <b>60149020</b> 77 00 867 360		 <b>60116026x8</b> 77 00 103 872 7x9,8/13.2x10	<b>21208003</b> 30x42x7 RD
<b>60116527</b> 77 01 471 719	<b>62457165</b> 77 00 273 486	 <b>60149018x4</b> 77 01 471 816				<b>21208001</b> 35x47x7 RD
						<b>21208012</b> 80x100x8 LD
		 <b>62457418x4</b> 82 00 275 057	 <b>62457222</b> 82 00 365 915		 <b>62457244x16</b> 77 00 103 938 5,5x11x28x16,4	<b>21204024x2</b> 28x42x5 RD
	<b>62457265</b> 77 00 103 687	 <b>62457219</b> 77 00 105 852				<b>21204005</b> 35x47x7 RD
						<b>21204009</b> 80x100x8 LD

■ : Delik - Çentik

■ : Hole - Notch

■ : Trou - Entaille

NOT: Katalogdaki Orijinal Kodlar Referans Amacıyla Kullanılmıştır.Lütfen COTECH Kodlarını Kullanınız.  
Original codes used for reference only.Please use COTECH codes for orders.

00



01



02



03



04



Silindir Kapak  
Cylinder Head  
Zylinderkopf  
Joint de culasse



Ltr	MODEL	PS/KW	ENGINE/MOTOR		
1,6 1598	<b>4 CYL ø79,5</b> CLIO 12/04--> CLIO 16V MODUS CLIO 12/04--> CLIO 16V MODUS TWINGO CLIO 16V 06/05-->	112 PS / 82 KW 133 PS / 98 KW 88 PS / 65 KW 88 PS / 65 KW	K4M 790 K4M 800 K4M 791 K4M 792 K4M 794 K4M 801 K4M 854 K4M 804	<b>62457402</b> Motor Full Takım Gasket Full Set <b>62457403</b> 77 01 474 372 <b>62457404</b> Alt Takım Conversion Set	 <b>62457205</b> 77 00 112 739 MLS ø80,5
	<b>4 CYL ø79,5</b> KANGOO 02/08--> LOGAN 09/04-->	105 PS / 77 KW 84 PS / 62 KW 87 PS / 64 KW	K7M 690 K7M 718 K7M 732 K7M 750 K7M 710	<b>60108902</b> 40108903+40149004 <b>60108903</b> 60 01 548 043 <b>60149004</b> Motor Alt Takım Conversion Set	 <b>60108905</b> 82 00 296 969 1,20mm FIBER / FIBRE <b>60108906</b> 82 00 296 969 MLS ø80,5
1,6	<b>4 CYL ø76</b> 21 OPTIMA FAIRWAY		C2L C3L	<b>60107602</b> 77 01 465 268	 <b>60107605</b> 77 00 733 041 1,80mm ø77
1,6 1647	<b>4 CYL ø79</b> R 18 TRAFIC FUEGO	73 PS / 53 KW 79 PS / 55 KW 66 PS / 50 KW	841 717 A2M 723 841 717 A2M 723 841 717 841 A1MP707	<b>60110002</b> 77 01 460 627	 <b>60110005</b> 77 01 460 708 1,20mm ø80,5
1,7 1721	<b>4 CYL ø81</b> TRAFIC 06/86-->08/94	68 PS / 50 KW	F1N 720 F1N 722 F1N 724	<b>60107002</b> Motor Full Takım Gasket Full Set <b>60107003</b> 77 01 466 406 <b>60107004</b> 77 01 462 817	 <b>60107005</b> 77 00 713 860 1,40mm ø82

▲ : İçerikte Bulunmamaktadır...

▲ : Not included in the set

▲ : Non inclus dans la pochette

00: Motor Takım Keçesiz ve Subap Lastiksiz











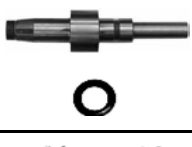
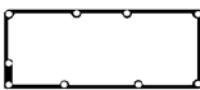





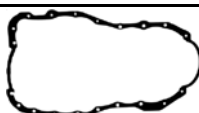





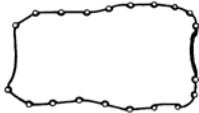

00: Gasket Set Without oil seals Without Valve Stem Seal

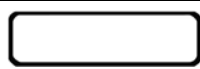
01: Motor Takım Keçesiz - Subap Lastikli

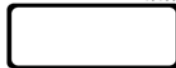
01: Gasket set With Valve Stem Seal Without Oil Seals

02: Motor Full Takım Keçeli ve Subap Lastikli

02: Gasket Full Set With oil seals and Valve Stem Seals

Subap Kapak Valve Cover Gasket Zylinderkopfhaube Couvre-culbut.	Karter Oil Pan Ölwanne Carter d'huile	Emme Manifold Intake Manifold Ansaug Admission	Egzoz Manifold Exhaust Manifold Auspuffkrümmer Collecteur D'echappement	Eksoz Boğaz Exhaust Pipe Auspuff Kehle	Supap Keçesi Valve Stem Seal Ventilschaft Queue de soupape	
						
	 <b>62457065</b> 82 00 379 654	 <b>62457219</b> 77 00 105 852	 <b>62457221</b> 77 00 107 181		 <b>62457244x16</b> 77 00 103 938 5,5x11x28x16,4	<b>21208071</b> 33x42x6 RD
		 <b>62457418x4</b> 82 00 275 057	 <b>62457222</b> 82 00 365 915			<b>21204024</b> 28x42x5 RD
						<b>21204005</b> 35x47x7 RD
						<b>21204009</b> 80x100x8 LD
						<b>21208003</b> 30x42x7 RD
<b>60116527</b> 77 01 471 719	<b>62457165</b> 77 00 273 486	<b>60108918x4</b> 77 01 471 932	<b>60108921</b> 8200191371		<b>60116026x8</b> 77 00 103 872 7x9,8/13.2x10	<b>21208001</b> 35x47x7 RD
						<b>21208012</b> 80x100x8 LD
 6,5mm <b>60102525</b> 77 01 348 574	 <b>60102267</b> 77 00 564 813	 <b>60103020</b> 77 00 855 962				<b>21208067</b> 35x50x10 RD
						<b>21201034</b> 80x100x13 LD
 <b>60110525</b> 77 00 725 186	 <b>60110265</b> 7700710279	 <b>60109020</b> 77 00 635 407				<b>21201010</b> 32x45x8 RD
						<b>21201034</b> 80x100x13 LD
 <b>60104525</b> 77 00 719 666	 <b>62427465</b>	 <b>60107021</b> 77 00 725 397				<b>21201002</b> 22x45x7 LD
					<b>40107027x8</b> 77 00 737 124 8x10,8x14,2x10	<b>21201003</b> 25x42x7 RD
						<b>21201027</b> 50x68x10 RD
						<b>21201038</b> 85x105x8 LD

■ : Delik - Çentik

■ : Hole - Notch

■ : Trou - Entaille

NOT: Katalogdaki Orjinal Kodlar Referans Amacıyla Kullanılmıştır.Lütfen COTECH Kodlarını Kullanınız.  
Original codes used for reference only.Please use COTECH codes for orders.

00



Silindir Kapak  
Cylinder Head

01



Zylinderkopf

02



Joint de culasse

03



04



Ltr MODEL PS/KW ENGINE/MOTOR

Ltr	MODEL	PS/KW	ENGINE/MOTOR		
1,7	4 CYL ø81				
1721	11 10/83-->	94 PS / 69 KW	F2N 700	<b>60107002</b>	
	19	73 PS / 54 KW	F2N 704	Motor Full Takım	
	21		F2N 708	Gasket Full Set	<b>60107005</b>
	CLIO		F2N 710		77 00 713 860
	SUPER 5		F2N 711	<b>60107003</b>	1,40mm
	5		F2N 712	77 01 466 406	
	9		F2N 716	<b>60107004</b>	<b>60107007</b>
			F2N 720	77 01 462 817	77 00 713 860
			F2N 721		1,60mm
			F2N 722		<b>ø82</b>
			F2N 724		
			F2N 726		
			F2N 727		
			F2N 728		
			F2N 730		
			F2N 732		
			F2N 740		
			F2N 742		
			F2N 750		
			F2N 752		
			F2N 753		
			F2N 754		
			F2N 758		
			F2N 770		
			F2N 783		
			F2N 786		
			F2N 796		
			F2N 797		
			F2N 798		
	11 10/84-->12/95	107 PS / 79 KW	F3N 702		
	19	73 PS / 54 KW	F3N 708		
	21		F3N 716		
	9		F3N 717		
	SUPER 5		F3N 718		
			F3N 722		
			F3N 723		
			F3N 726		
			F3N 740		
			F3N 741		
			F3N 742		
			F3N 743		
			F3N 746		

▲ : İçerikte Bulunmamaktadır...

▲ : Not included in the set

▲ : Non inclus dans la pochette

00: Motor Takım Keçesiz ve Subap Lastiksiz









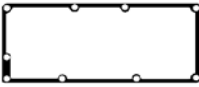

00: Gasket Set Without oil seals Without Valve Stem Seal

01: Motor Takım Keçesiz - Subap Lastikli

01: Gasket set With Valve Stem Seal Without Oil Seals

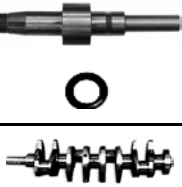
02: Motor Full Takım Keçeli ve Subap Lastikli

02: Gasket Full Set With oil seals and Valve Stem Seals

<p>Subap Kapak Valve Cover Gasket Zylinderkopfhaube Couvre-culbut.</p> 	<p>Karter Oil Pan Ölwanne Carter d'huile</p> 	<p>Emme Manifold Intake Manifold Ansaug Admission</p> 	<p>Egzoz Manifold Exhaust Manifold Auspuffkrümmer Collecteur D'echappement</p> 	<p>Eksoz Boğaz Exhaust Pipe Auspuff Kehle</p> 	<p>Supap Keçesi Valve Stem Seal Ventilschaft Queue de soupape</p> 	
 <p><b>60104525</b> 77 00 719 666</p>	 <p><b>62427465</b></p>	 <p><b>60107021</b> 77 00 725 397</p>			 <p><b>60107027x8</b> 77 00 737 124 <b>8x10,8x14,2x10</b></p>	<p><b>21201002</b> 22x45x7 LD</p> <p><b>21201003</b> 25x42x7 RD</p> <p><b>21201027</b> 50x68x10 RD</p> <p><b>21201038</b> 85x105x8 LD</p>

■ : Delik - Çentik

■ : Hole - Notch

■ : Trou - Entaille

NOT: Katalogdaki Orjinal Kodlar Referans Amacıyla Kullanılmıştır.Lütfen COTECH Kodlarını Kullanınız.  
Original codes used for reference only.Please use COTECH codes for orders.

00



Silindir Kapak

Cylinder Head

01



Zylinderkopf

02



Joint de culasse

03



04



Ltr	MODEL	PS/KW	ENGINE/MOTOR		
1,8 1794	4 CYL ø82,7 CLIO CLIO Rsi LAGUNA 19 08/90-->03/01	110 PS / 81 KW 88 PS / 65 KW	F3P 670 F3P 676 F3P 678 F3P 682 F3P 700 F3P 704 F3P 705 F3P 706 F3P 707 F3P 708 F3P 710 F3P 712 F3P 714 F3P 720 F3P 724 F3P 754 F3P 755 F3P 758 F3P 760 F3P 764 F3P 765	<b>60134002</b> Motor Full Takım Gasket Full Set  <b>60134003</b> 77 01 467 058  <b>60113004</b> 77 01 462 817	 <b>60134005</b> 77 00 859 273 1,20mm  <b>60134007</b> 77 00 859 273 1,60mm <b>ø83,7</b>
1,8 1794	4 CYL ø82,7 LAGUNA 06/95-->02/01	94 PS / 69 KW	F3P 674	<b>60134003</b> 77 01 467 058  <b>60152104</b> 77 01 470 176	 <b>60134005</b> 77 00 859 273 1,20mm  <b>60134007</b> 77 00 859 273 1,60mm <b>ø83,7</b>
1,8 1783	4 CYL ø82,7 LAGUNA 16V MEGANE Grandtour 16V MEGANE 16V SCÉNIC SCÉNIC 16V LAGUNA 16V 04/98--> 03/01-->	120 PS / 88 KW 115 PS / 85 KW  121 PS / 89 KW 116 PS / 85 KW	F4P 720 F4P 722 F4P 760 F4P 771 F4P 773 F4P 775 F4P 770 F4P 772 F4P 774	<b>62457302</b> Motor Full Takım Gasket Full Set  <b>62457303</b> 77 01 471 278  <b>62457304</b> 77 01 477 218 77 01 471 360	 <b>62457305</b> 77 00 108 254 <b>MLS</b> <b>ø84</b>

▲ : İçerikte Bulunmamaktadır...

▲ : Not included in the set

▲ : Non inclus dans la pochette

00: Motor Takım Keçesiz ve Subap Lastiksiz











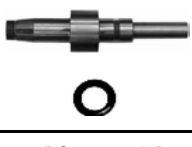
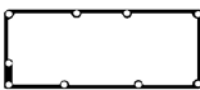







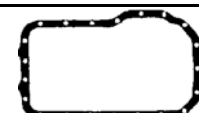

00: Gasket Set Without oil seals Without Valve Stem Seal

01: Motor Takım Keçesiz - Subap Lastikli

01: Gasket set With Valve Stem Seal Without Oil Seals

02: Motor Full Takım Keçeli ve Subap Lastikli

02: Gasket Full Set With oil seals and Valve Stem Seals

Subap Kapak Valve Cover Gasket Zylinderkopfhaube Couvre-culbut.	Karter Oil Pan Ölwanne Carter d'huile	Emme Manifold Intake Manifold Ansaug Admission	Egzoz Manifold Exhaust Manifold Auspuffkrümmer Collecteur D'echappement	Eksoz Boğaz Exhaust Pipe Auspuff Kehle	Supap Keçesi Valve Stem Seal Ventilschaft Queue de soupape	
						
 <b>60104525</b> 77 00 719 666	 <b>60113265</b> 77 00 859 751	 <b>60134021</b> 77 00 854 539			 <b>60107027x8</b> 77 00 737 124 8x10,8x14,2x10	<b>21201002</b> 22x45x7 LD <b>21201003</b> 25x42x7 RD <b>21201027</b> 50x68x10 RD <b>21201038</b> 85x105x8 LD
 <b>60104525</b> 77 00 719 666	 <b>60152065</b> 77 00 114 424	 <b>60134021</b> 77 00 854 539			 <b>60107027x8</b> 77 00 737 124 8x10,8x14,2x10	<b>21201002</b> 22x45x7 LD <b>21201003</b> 25x42x7 RD <b>21204014</b> 42x54x6 RD <b>21208011</b> 85x105x11 LD
	 <b>60152065</b> 77 00 114 424	 <b>62457319</b> 77 00 109 906  <b>62457218x4</b> 82 00 052 312	 <b>62457321</b> 77 00 105 843		 <b>62457244x16</b> 77 00 103 938 5,5x11x2816,4	<b>21208070x2</b> 28x47x5,5 RD <b>21204014</b> 42x54x6 RD <b>21208011</b> 85x105x11 LD

■ : Delik - Çentik

■ : Hole - Notch

■ : Trou - Entaille

NOT: Katalogdaki Orijinal Kodlar Referans Amacıyla Kullanılmıştır.Lütfen COTECH Kodlarını Kullanınız.  
Original codes used for reference only.Please use COTECH codes for orders.

00



01



02



03











04



Silindir Kapak  
Cylinder Head  
Zylinderkopf  
Joint de culasse



Ltr	MODEL	PS/KW	ENGINE/MOTOR		
1,9 1870	<b>4 CYL ø80</b> CLIO DTi 03/99--> CLIO DTi ESPACE dCi ESPACE DCI KANGOO DCI KANGOO DTi LAGUNA dCi LAGUNA DCI MASTER DCI MEGANE dCi MEGANE DCI MEGANE DCI MEGANE DTi MEGANE Grandtour DCI MEGANE Grandtour DTi SCÉNIC DCI SCÉNIC DTi TRAFIC dCi TRAFIC DCI TRAFIC 1.9 dCi	120 PS / 88 KW 80 PS / 59 KW	F9Q 650 F9Q 664 F9Q 674 F9Q 680 F9Q 717 F9Q 718 F9Q 732 F9Q 733 F9Q 738 F9Q 740 F9Q 744 F9Q 748 F9Q 750 F9Q 751 F9Q 752 F9Q 754 F9Q 756 F9Q 760 F9Q 762 F9Q 772 F9Q 774 F9Q 780 F9Q 782 F9Q 790 F9Q 800 F9Q 808 F9Q 820 F9Q 826	<b>60152102</b> Motor Takım Gasket Set  <b>60152103</b> 77 01 470 288  <b>60152104</b> 77 01 470 176	 <b>60152205</b> 82 00 780 116 1,32mm <b>60152206</b> 82 00 780 116 1,60mm <b>MLS</b> <b>ø81</b>
1,9 1870	<b>4 CYL ø80</b> LAGUNA DTi 03/97-->08/03 MEGANE DTi MEGANE Scenic DTi SCÉNIC DTi	98 PS / 72 KW	F9Q 716 F9Q 730 F9Q 734 F9Q 722 F9Q 731 F9Q 736	<b>60152102</b> Motor Takım Gasket Set  <b>60152103</b> 77 01 470 288  <b>60152104</b> 77 01 470 176	 <b>60152105</b> 77 00 859 059 1,45mm 1  <b>60152106</b> 77 00 105 392 1,35mm 2  <b>60152107</b> 77 00 105 393 1,55mm 3  <b>FIBER / FIBRE</b> <b>ø81</b>

▲ : İçerikte Bulunmamaktadır...

▲ : Not included in the set

▲ : Non inclus dans la pochette

00: Motor Takım Keçesiz ve Subap Lastiksiz











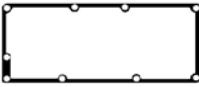





00: Gasket Set Without oil seals Without Valve Stem Seal

01: Motor Takım Keçesiz - Subap Lastikli

01: Gasket set With Valve Stem Seal Without Oil Seals

02: Motor Full Takım Keçeli ve Subap Lastikli

02: Gasket Full Set With oil seals and Valve Stem Seals

<p>Subap Kapak Valve Cover Gasket Zylinderkopfhaube Couvre-culbut.</p> 	<p>Karter Oil Pan Ölwanne Carter d'huile</p> 	<p>Emme Manifold Intake Manifold Ansaug Admission</p> 	<p>Egzoz Manifold Exhaust Manifold Auspuffkrümmer Collecteur D'echappement</p> 	<p>Eksoz Boğaz Exhaust Pipe Auspuff Kehle</p> 	<p>Supap Keçesi Valve Stem Seal Ventilschaft Queue de soupape</p> 	  
 <p><b>60152025</b> 82 00 060 882</p>	 <p><b>60152065</b> 77 00 114 424</p>	 <p><b>60152121</b> 77 00 874 592</p>			 <p><b>60116026x8</b> 77 00 736 465 <b>7x9,8/13.2x10</b></p>	<p><b>21204002</b> 25x42x8 RD</p> <p><b>21204014</b> 42x54x6 RD</p> <p><b>21208011</b> 85x105x11 LD</p>
 <p><b>60152025</b> 82 00 060 882</p>	 <p><b>60152065</b> 77 00 114 424</p>	 <p><b>60152121</b> 77 00 874 592</p>			 <p><b>60116026x8</b> 77 00 736 465 <b>7x9,8/13.2x10</b></p>	<p><b>21204002</b> 25x42x8 RD</p> <p><b>21204014</b> 42x54x6 RD</p> <p><b>21208011</b> 85x105x11 LD</p>

■ : Delik - Çentik

■ : Hole - Notch

■ : Trou - Entaille

NOT: Katalogdaki Orjinal Kodlar Referans Amacıyla Kullanılmıştır.Lütfen COTECH Kodlarını Kullanınız.  
Original codes used for reference only.Please use COTECH codes for orders.

00



01



02



03



04



Silindir Kapak  
Cylinder Head  
Zylinderkopf  
Joint de culasse



Ltr	MODEL	PS/KW	ENGINE/MOTOR		
1,9 1870	<b>4 CYL ø80</b> MEGANE DTI 01/96--> MEGANE Scenic DTI TRAFIC D MEGANE D 09/90--> MEGANE DTI MEGANE Scenic DTI MEGANE TDI 19 D 19 DT 19 TD	90 PS / 66 KW 60 PS / 44 KW 94 PS / 69 KW 90 PS / 66 KW	F8Q 600 F8Q 606 F8Q 786 F8Q 610 F8Q 740 F8Q 744 F8Q 768 F8Q 784		
					 <b>60152005</b> 82 00 188 391 1,60mm 3 <b>M</b> <b>60152006</b> 82 00 188 114 1,50mm 1 <b>M</b> <b>60152007</b> 82 00 188 390 1,40mm 2 <b>M</b> <b>ø81</b>
1,9 1870	<b>4 CYL ø80</b> 19 D 03/86--> 21 D MEGANE D MEGANE Grandtour D MEGANE Scenic DCI RAPID D CLIO CLIO D	65 PS / 48 KW 54 PS / 40 KW	F8Q 620 F8Q 622 F8Q 640 F8Q 678 F8Q 682 F8Q 706 F8Q 710 F8Q 714 F8Q 722 F8Q 724 F8Q 730 F8Q 732 F8Q 742 F8Q 764 F8Q 774 F8Q 776 F8Q 790	<b>60113102</b> Motor Full Takım Gasket Full Set  <b>60113002</b> Motor Takım Gasket Set   <b>60113003</b> 77 01 462 816   <b>60113004</b> 77 01 462 817	 <b>60113005</b> 77 00 745 725 1,85mm 3 <b>M</b> <b>60113006</b> 77 00 743 369 1,75mm 1 <b>M</b> <b>60113007</b> 77 00 745 724 1,65mm 2 <b>M</b> <b>ø81</b>
1,9 1870	<b>4 CYL ø80</b> CLIO D 01/96--> CLIO dCi KANGOO MEGANE D THALIA D	90 PS / 66 KW 54 PS / 40 KW	F8Q 624 F8Q 630 F8Q 632 F8Q 636 F8Q 644 F8Q 648 F8Q 662	<b>60151902</b> Motor Full Takım Gasket Full Set  <b>60152002</b> Motor Takım Gasket Set   <b>60113003</b> 77 01 462 816   <b>60152104</b> 77 01 470 176	 <b>60152005</b> 82 00 188 391 1,60mm 3 <b>M</b> <b>60152006</b> 82 00 188 114 1,50mm 1 <b>M</b> <b>60152007</b> 82 00 188 390 1,40mm 2 <b>M</b> <b>ø81</b>

▲ : İçerikte Bulunmamaktadır...

▲ : Not included in the set

▲ : Non inclus dans la pochette

00: Motor Takım Keçesiz ve Subap Lastiksiz











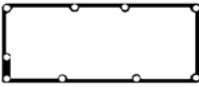

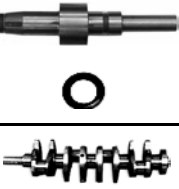
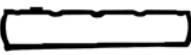

00: Gasket Set Without oil seals Without Valve Stem Seal

01: Motor Takım Keçesiz - Subap Lastikli

01: Gasket set With Valve Stem Seal Without Oil Seals

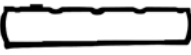
02: Motor Full Takım Keçeli ve Subap Lastikli

02: Gasket Full Set With oil seals and Valve Stem Seals

<p>Subap Kapak Valve Cover Gasket Zylinderkopfhaube Couvre-culbut.</p> 	<p>Karter Oil Pan Ölwanne Carter d'huile</p> 	<p>Emme Manifold Intake Manifold Ansaug Admission</p> 	<p>Egzoz Manifold Exhaust Manifold Auspuffkrümmer Collecteur D'echappement</p> 	<p>Eksoz Boğaz Exhaust Pipe Auspuff Kehle</p> 	<p>Supap Keçesi Valve Stem Seal Ventilschaft Queue de soupape</p> 	
 <p><b>60104525</b> 77 00 719 666</p>	 <p><b>60113265</b> 77 00 859 751</p>	 <p><b>60113021</b> 77 00 103 849</p>			 <p><b>60107027x8</b> 77 00 737 124 8x10,8x14,2x10</p>	<p><b>21204002</b> 25x42x8 RD</p> <p><b>21201027</b> 50x68x10 RD</p> <p><b>21201038</b> 85x105x8 LD</p>
 <p><b>60104525</b> 77 00 719 666</p>	 <p><b>60152065</b> 77 00 114 424</p>	 <p><b>60113021</b> 77 00 103 849</p>			 <p><b>60107027x8</b> 77 00 737 124 8x10,8x14,2x10</p>	<p><b>21204002</b> 25x42x8 RD</p> <p><b>21204014</b> 42x54x6 RD</p> <p><b>21208011</b> 85x105x11 LD</p>

■ : Delik - Çentik

■ : Hole - Notch

■ : Trou - Entaille

NOT: Katalogdaki Orijinal Kodlar Referans Amacıyla Kullanılmıştır.Lütfen COTECH Kodlarını Kullanınız.  
Original codes used for reference only.Please use COTECH codes for orders.

00



Silindir Kapak

Cylinder Head

01



Zylinderkopf

02



Joint de culasse

03



04



Ltr	MODEL	PS/KW	ENGINE/MOTOR		
2.0 1998	4 CYL ø82,7 ESPACE 06/95--> LAGUNA MEGANE MEGANE Scenic	114 PS / 84 KW 109 PS / 80 KW	F3R 611 F3R 742 F3R 768 F3R 769 F3R 791 F3R 796 F3R 797 F3R 798	60134003 77 01 467 058  60152104 77 01 470 176	 <b>60134005</b> 77 00 859 273 1,20mm <b>60134007</b> 1,60mm ø83,7
2.0 1998	4 CYL ø82,7 ESPACE 11/93--> LAGUNA MEGANE MEGANE Scenic	114 PS / 84 KW 109 PS / 80 KW	F3R 722 F3R 723 F3R 728 F3R 729 F3R 750 F3R 751 F3R 752	60134002 Motor Full Takım Gasket Full Set  60134003 77 01 467 058  60113004 77 01 462 817	 <b>60134005</b> 77 00 859 273 1,20mm <b>60134007</b> 1,60mm ø83,7
2.0 1998	4 CYL ø82,7 CLIO 16V 10/98--> ESPACE ESPACE 16V GRAND SCÉNIC LAGUNA LAGUNA 16V MEGANE MEGANE 16V SCÉNIC SCÉNIC 16V THALIA  CLIO 16V 03/01--> TRAFIC  ESPACE 11/02--> TRAFIC	169 PS / 124 KW 133 PS / 98 KW             179 PS / 132 KW 120 PS / 88 KW  136 PS / 100 KW 117 PS / 86 KW	F4R 700 F4R 701 F4R 712 F4R 713 F4R 714 F4R 715 F4R 730 F4R 732 F4R 736 F4R 738 F4R 740 F4R 741 F4R 744 F4R 746 F4R 747 F4R 770 F4R 771 F4R 780 F4R 790 F4R 791 F4R 720 F4R 722 F4R 738 F4R 792 F4R 820		 <b>62457305</b> 77 00 108 254 <b>MLS</b> ø84

▲ : İçerikte Bulunmamaktadır...

▲ : Not included in the set

▲ : Non inclus dans la pochette

00: Motor Takım Keçesiz ve Subap Lastiksiz











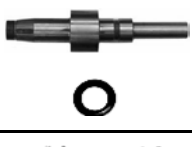
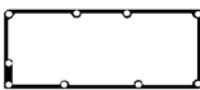



00: Gasket Set Without oil seals Without Valve Stem Seal

01: Motor Takım Keçesiz - Subap Lastikli

01: Gasket set With Valve Stem Seal Without Oil Seals

02: Motor Full Takım Keçeli ve Subap Lastikli

02: Gasket Full Set With oil seals and Valve Stem Seals

Subap Kapak Valve Cover Gasket Zylinderkopfhaube Couvre-culbut.	Karter Oil Pan Ölwanne Carter d'huile	Emme Manifold Intake Manifold Ansaug Admission	Egzoz Manifold Exhaust Manifold Auspuffkrümmer Collecteur D'echappement	Eksoz Boğaz Exhaust Pipe Auspuff Kehle	Supap Keçesi Valve Stem Seal Ventilschaft Queue de soupape	
						
						<b>21201002</b> 22x45x7 LD
<b>60104525</b> 77 00 719 666	<b>60152065</b> 77 00 114 424	<b>60134021</b> 77 00 854 539			<b>60107027x8</b> 77 00 737 124 8x10,8x14,2x10	<b>21201003</b> 25x42x7 RD
						<b>21204014</b> 42x54x6 RD
						<b>21208011</b> 85x105x11 LD
						<b>21201002</b> 22x45x7 LD
<b>60104525</b> 77 00 719 666	<b>60113265</b> 77 00 859 751	<b>60134021</b> 77 00 854 539			<b>60107027x8</b> 77 00 737 124 8x10,8x14,2x10	<b>21201003</b> 25x42x7 RD
						<b>21201027</b> 50x68x10 RD
						<b>21201038</b> 85x105x8 LD

■ : Delik - Çentik

■ : Hole - Notch

■ : Trou - Entaille

NOT: Katalogdaki Orijinal Kodlar Referans Amacıyla Kullanılmıştır.Lütfen COTECH Kodlarını Kullanınız.  
Original codes used for reference only.Please use COTECH codes for orders.

00



Silindir Kapak  
Cylinder Head

01



Zylinderkopf

02



Joint de culasse

03



04

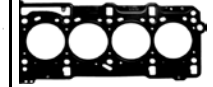

Ltr	MODEL	PS/KW	ENGINE/MOTOR		
2.0	4 CYL ø88				
1995	21	03/80-->07/98	120 PS / 88 KW	J5R 716	60112002
	25		79 PS / 58 KW	J5R 718	77 01 460 132
	MASTER			J5R 722	
	MASTER D			J5R 726	
	TRAFIC			J5R 728	
				J7R 722	
				J7R 723	
				J7R 746	
				J7R 747	
				J7R 750	
				J7R 751	
				829 720	
				829 721	
				829 730	
				829 731	
	18	10/77-->10/96	118 PS / 87 KW	J6R 234	
	20		101 PS / 74 KW	J6R 236	
	21			J6R 706	
	25			J6R 707	
	ESPACE			J6R 710	
	FUEGO			J6R 711	
				J6R 712	
				J6R 713	
				J6R 714	
				J6R 715	
				J6R 716	
				J6R 726	
				J6R 734	
				J6R 758	
				J6R 759	
				J6R 760	
				J6R 762	
				J6R 763	
				J6R 792	
				J6R 793	
				J7R 760	
				J7R 768	
				829 700	
				829 701	
				829 702	
				829 703	
				829 710	
	TRAFIC	03/80-->12/86	103 PS / 76 KW	829 702	
	20		79 PS / 58 KW	829 703	
				829 720	
				829 721	



60112005  
77 00 720 788  
ø89

▲ : İçerikte Bulunmamaktadır...

▲ : Not included in the set

▲ : Non inclus dans la pochette

00: Motor Takım Keçesiz ve Subap Lastiksiz











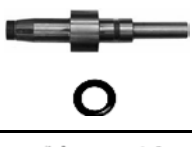
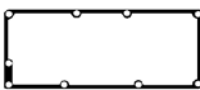

00: Gasket Set Without oil seals Without Valve Stem Seal

01: Motor Takım Keçesiz - Subap Lastikli

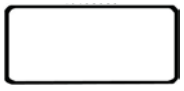
01: Gasket set With Valve Stem Seal Without Oil Seals

02: Motor Full Takım Keçeli ve Subap Lastikli

02: Gasket Full Set With oil seals and Valve Stem Seals

Subap Kapak Valve Cover Gasket Zylinderkopfhaube Couvre-culbut.	Karter Oil Pan Ölwanne Carter d'huile	Emme Manifold Intake Manifold Ansaug Admission	Egzoz Manifold Exhaust Manifold Auspuffkrümmer Collecteur D'echappement	Eksoz Boğaz Exhaust Pipe Auspuff Kehle	Supap Keçesi Valve Stem Seal Ventilschaft Queue de soupape	
						
 <b>60112225</b> 77 00 614 729	 <b>60112265</b> 77 00 591 167	 <b>60112018x4</b> 77 00 728 729  <b>60112019x4</b> 77 00 622 284	 <b>60112120</b> 77 00 622 286	 <b>60112017</b> 77 00 679 861	 <b>60107027x8</b> 77 00 737 124 <b>8x10,8x14,2x10</b>	<b>21201008</b> 30x40x7 RD <b>21201012</b> 35x47x7 RD
						<b>21201027</b> 50x68x10 RD <b>21201041</b> 90x110x11











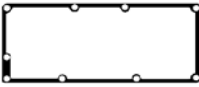

■ : Delik - Çentik

■ : Hole - Notch

■ : Trou - Entaille

NOT: Katalogdaki Orijinal Kodlar Referans Amacıyla Kullanılmıştır.Lütfen COTECH Kodlarını Kullanınız.  
Original codes used for reference only.Please use COTECH codes for orders.



<p>Subap Kapak Valve Cover Gasket Zylinderkopfhaube Couvre-culbut.</p> 	<p>Karter Oil Pan Ölwanne Carter d'huile</p> 	<p>Emme Manifold Intake Manifold Ansaug Admission</p> 	<p>Egzoz Manifold Exhaust Manifold Auspuffkrümmer Collecteur D'echappement</p> 	<p>Eksoz Boğaz Exhaust Pipe Auspuff Kehle</p> 	<p>Supap Keçesi Valve Stem Seal Ventilschaft Queue de soupape</p> 	  
 <p><b>60111525</b> 77 00 662 455</p>	 <p><b>60111265</b> 77 00 591 167</p>	 <p><b>60111020</b> 77 00 853 496</p>		 <p><b>60107027x8</b> 77 00 737 124 8x10,8x14,2x10</p>	<p><b>21201008</b> 30x40x7 RD</p> <p><b>21201012</b> 35x47x7 RD</p>	<p><b>21201027</b> 50x68x10 RD</p> <p><b>21201041</b> 90x110x11</p>

■ : Delik - Çentik

■ : Hole - Notch

■ : Trou - Entaille

NOT: Katalogdaki Orijinal Kodlar Referans Amacıyla Kullanılmıştır.Lütfen COTECH Kodlarını Kullanınız.  
Original codes used for reference only.Please use COTECH codes for orders.

00



Silindir Kapak  
Cylinder Head  
Zylinderkopf  
Joint de culasse

01



02



03



04

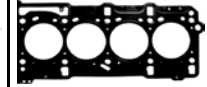

Ltr	MODEL	PS/KW	ENGINE/MOTOR		
2,2 2165	<b>4 CYL ø88</b> ESPACE MASTER TRAFIC 03/80-->07/98	110 PS / 81 KW 91 PS / 67 KW	J7T 284 J7T 600 J7T 718 J7T 719 J7T 734 J7T 736 J7T 756 J7T 770 J7T 772 J7T 773 J7T 776 J7T 780 J7T 782 J7T 788	<b>60112002</b> 77 01 460 132	 <b>60112005</b> 77 00 720 788 <b>ø89</b>
21 25	04/84-->12/89	124 PS / 91 KW 110 PS / 81 KW	J7T 706 J7T 707 J7T 714 J7T 715 J7T 730 J7T 731 J7T 755		
21 25	06/86-->06/94	110 PS / 81 KW 107 PS / 79 KW	J7T 708 J7T 732 J7T 733 J7T 754 J7T 755		
20	10/80-->12/83	116 PS / 85 KW	851 700		
2,4 2445	<b>4 CYL ø93</b> MASTER D MASTER D MASTER D 08/93-->02/98 09/86-->12/92 09/86-->10/89	71 PS / 52 KW 72 PS / 53 KW 72 PS / 53 KW	S8U 730 S8U 730 S8U 731		 <b>60147005</b> 77 01 040 180 1,80mm <b>60147006</b> 77 01 040 179 1,70mm <b>ø95,2</b>
2,5 2499	<b>4 CYL ø93</b> TRAFIC D MASTER D TRAFIC D MASTER D MASTER D TRAFIC D TRAFIC 05/89-->03/01 03/80-->07/98 03/80-->07/98 07/80-->10/89 03/89-->	69 PS / 51 KW 71 PS / 52 KW 69 PS / 51 KW 75 PS / 55 KW 76 PS / 56 KW 75 PS / 55 KW	S8U 720 S8U 722 S8U 731 S8U 742 S8U 742 S8U 748 S8U 750 S8U 752 S8U 758		 <b>60147005</b> 77 01 040 180 1,80mm <b>60147006</b> 77 01 040 179 1,70mm <b>ø95,2</b>

▲ : İçerikte Bulunmamaktadır...

▲ : Not included in the set

▲ : Non inclus dans la pochette

00: Motor Takım Keçesiz ve Subap Lastiksiz











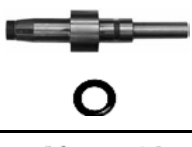
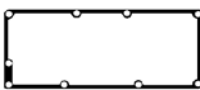

00: Gasket Set Without oil seals Without Valve Stem Seal

01: Motor Takım Keçesiz - Subap Lastikli

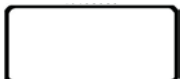
01: Gasket set With Valve Stem Seal Without Oil Seals

02: Motor Full Takım Keçeli ve Subap Lastikli

02: Gasket Full Set With oil seals and Valve Stem Seals

Subap Kapak Valve Cover Gasket Zylinderkopfhaube Couvre-culbut.	Karter Oil Pan Ölwanne Carter d'huile	Emme Manifold Intake Manifold Ansaug Admission	Egzoz Manifold Exhaust Manifold Auspuffkrümmer Collecteur D'echappement	Eksoz Boğaz Exhaust Pipe Auspuff Kehle	Supap Keçesi Valve Stem Seal Ventilschaft Queue de soupape	
						
 <b>60112225</b> 77 00 614 729	 <b>60112265</b> 77 00 591 167	 <b>60112018x4</b> 77 00 728 729	 <b>60112120</b> 77 00 622 286	 <b>60112017</b> 77 00 679 861	 <b>60107027x8</b> 77 00 737 124 8x10,8x14,2x10	<b>21201008</b> 30x40x7 RD
		 <b>60112019x4</b> 77 00 622 284				<b>21201012</b> 35x47x7 RD
						<b>21201027</b> 50x68x10 RD
						<b>21201041</b> 90x110x11

■ : Delik - Çentik

■ : Hole - Notch

■ : Trou - Entaille

NOT: Katalogdaki Orijinal Kodlar Referans Amacıyla Kullanılmıştır.Lütfen COTECH Kodlarını Kullanınız.  
Original codes used for reference only.Please use COTECH codes for orders.

00



01



02



03









04



Silindir Kapak  
Cylinder Head  
Zylinderkopf  
Joint de culasse



Ltr	MODEL	PS/KW	ENGINE/MOTOR		
2,5 2499	4 CYL ø93 MASTER D 07/98-->01/01	80 PS / 59 KW	S8U 770	60139000 99477116 	 <b>60147005</b> 77 01 040 180 1,80mm  <b>60147006</b> 77 01 040 179 1,70mm <b>ø95,2</b>
2,5 2499	4 CYL ø93 TRAFIC D 05/98--> MASTER D 08/80-->07/98 TRAFIC D 03/80-->03/01 MASTER D 05/89-->03/01 TRAFIC D	75 PS / 55 KW 71 PS / 52 KW 69 PS / 51 KW 75 PS / 55 KW	S8U 780 S8U 782 8140.61.2300 8140.61.240 8140.67.2500 8140.67.2510 8140.67.2550 8140.67.2580		 <b>60147005</b> 77 01 040 180 1,80mm  <b>60147006</b> 77 01 040 179 1,70mm <b>ø95,2</b>
2,5 2499	4 CYL ø93 MASTER TD MASTER DT 08/89-->07/98	94 PS / 69 KW 98 PS / 72 KW 116 PS / 85 KW 95 PS / 70 KW	S9U 700 S9U 704 8140.07 8140.27 8140.47 SU9 702 8140.27.2580 S9U 714 S9U 740 8140.27.2500 8140.27.2510		 <b>60138005</b> 77 01 043 277 1,50mm  <b>60138006</b> 77 01 043 276 1,40mm <b>ø95</b>
2,7 2664	6 CYL ø88 25 V6 04/84-->08/89 30 02/75-->01/84 30 TS 10/78-->12/83 30 TX	141 PS / 104 KW 131 PS / 96 KW 125 PS / 92 KW 143 PS / 105 KW	Z7V 708 Z7V 709 Z7V 711 112 144 140		 79 10 245 291 1,20mm   79 10 245 585 1,20mm <b>ø90</b> <b>60115005</b>

▲ : İçerikte Bulunmamaktadır...

▲ : Not included in the set

▲ : Non inclus dans la pochette

00: Motor Takım Keçesiz ve Subap Lastiksiz











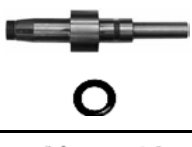
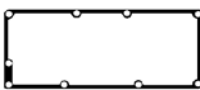

00: Gasket Set Without oil seals Without Valve Stem Seal

01: Motor Takım Keçesiz - Subap Lastikli

01: Gasket set With Valve Stem Seal Without Oil Seals

02: Motor Full Takım Keçeli ve Subap Lastikli

02: Gasket Full Set With oil seals and Valve Stem Seals

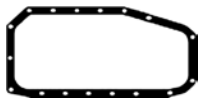
Subap Kapak Valve Cover Gasket Zylinderkopfhaube Couvre-culbut.	Karter Oil Pan Ölwanne Carter d'huile	Emme Manifold Intake Manifold Ansaug Admission	Egzoz Manifold Exhaust Manifold Auspuffkrümmer Collecteur D'echappement	Eksoz Boğaz Exhaust Pipe Auspuff Kehle	Supap Keçesi Valve Stem Seal Ventilschaft Queue de soupape	
						
 <b>60138045</b> 50 01 846 751	 <b>60146066</b> 77 01 043 496	 <b>60146019x4</b> 77 00 034 967	 <b>60147021x4</b> 77 01 05 824			
 <b>60138047</b> 0249.C3	 <b>60138068</b> 500327440					

■ : Delik - Çentik

■ : Hole - Notch

■ : Trou - Entaille

NOT: Katalogdaki Orijinal Kodlar Referans Amacıyla Kullanılmıştır.Lütfen COTECH Kodlarını Kullanınız.  
Original codes used for reference only.Please use COTECH codes for orders.

00



Silindir Kapak  
Cylinder Head

01



Zylinderkopf

02



Joint de culasse



03



04



Ltr MODEL PS/KW ENGINE/MOTOR

2,8 2799	4 CYL ø94,4 MASTER DTI	07/98-->	114 PS / 84 KW	S9W 700 S9W 702	60139100 71713696 	 <b>60139005</b> 77 01 044 227 1,50mm <b>60139006</b> 77 01 044 226 1,40mm <b>60139007</b> 77 01 044 225 1,30mm ø96
-------------	---------------------------	----------	----------------	--------------------	---	--

▲ : İçerikte Bulunmamaktadır...

▲ : Not included in the set

▲ : Non inclus dans la pochette

00: Motor Takım Keçesiz ve Subap Lastiksiz











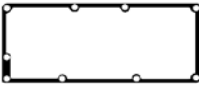

00: Gasket Set Without oil seals Without Valve Stem Seal

01: Motor Takım Keçesiz - Subap Lastikli

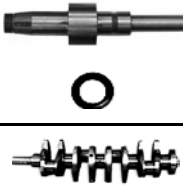
01: Gasket set With Valve Stem Seal Without Oil Seals

02: Motor Full Takım Keçeli ve Subap Lastikli

02: Gasket Full Set With oil seals and Valve Stem Seals

<p>Subap Kapak Valve Cover Gasket Zylinderkopfhaube Couvre-culbut.</p> 	<p>Karter Oil Pan Ölwanne Carter d'huile</p> 	<p>Emme Manifold Intake Manifold Ansaug Admission</p> 	<p>Egzoz Manifold Exhaust Manifold Auspuffkrümmer Collecteur D'echappement</p> 	<p>Eksoz Boğaz Exhaust Pipe Auspuff Kehle</p> 	<p>Supap Keçesi Valve Stem Seal Ventilschaft Queue de soupape</p> 	
 <p><b>60138045</b> 50 01 846 751</p>  <p><b>60138047</b> 0249.C3</p>	 <p><b>60138068</b> 500327440</p>	 <p><b>60146019x4</b> 77 00 034 967</p>	 <p><b>60147021x4</b> 77 01 035 824</p>			

■ : Delik - Çentik

■ : Hole - Notch

■ : Trou - Entaille

NOT: Katalogdaki Orijinal Kodlar Referans Amacıyla Kullanılmıştır.Lütfen COTECH Kodlarını Kullanınız.  
Original codes used for reference only.Please use COTECH codes for orders.

00



Silindir Kapak  
Cylinder Head

01



Zylinderkopf

02



Joint de culasse

03



04

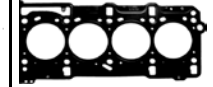

Ltr	MODEL	PS/KW	ENGINE/MOTOR		
2,2 2140	4 CYL 88x88 ESSENCE 671				<p><b>60135005</b> 855783800 1,30mm ø88</p>
2,6 2600	4 CYL ø93 / 96 ESSENCE 817				<p><b>60145005</b> 5000131017 1,30mm ø96</p>
3,0 3,3 3,6 3017 3319 3595	4 CYL 98 / 102 TRAFIC SG-2M TRAFIC SG-4 TRAFIC SG-5 TRAFIC SG-5SD TRAFIC SG-5C	70 PS / 51 KW 73 PS / 54 KW	599 599 712	<b>60150001</b> 996090400	<p><b>60150005</b> 5000044437 1,40mm ø110</p>
3,6 3595	4 CYL ø102 TRAFIC SG-5C T.D	90 PS / 66 KW		<b>60151101</b> 500336300	<p><b>60150006</b> 5000044908 2,00mm ø110</p>

▲ : İçerikte Bulunmamaktadır...

▲ : Not included in the set

▲ : Non inclus dans la pochette

00: Motor Takım Keçesiz ve Subap Lastiksiz











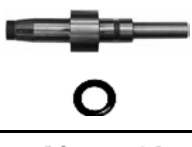
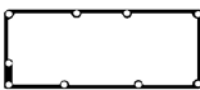





00: Gasket Set Without oil seals Without Valve Stem Seal

01: Motor Takım Keçesiz - Subap Lastikli

01: Gasket set With Valve Stem Seal Without Oil Seals

02: Motor Full Takım Keçeli ve Subap Lastikli

02: Gasket Full Set With oil seals and Valve Stem Seals

Subap Kapak Valve Cover Gasket Zylinderkopfhaube Couvre-culbut.	Karter Oil Pan Ölwanne Carter d'huile	Emme Manifold Intake Manifold Ansaug Admission	Egzoz Manifold Exhaust Manifold Auspuffkrümmer Collecteur D'echappement	Eksoz Boğaz Exhaust Pipe Auspuff Kehle	Supap Keçesi Valve Stem Seal Ventilschaft Queue de soupape	
						
 <b>60117034</b> 5000041255	 <b>60117013</b> 428297200	 <b>60117018x4</b> 5000049389	 <b>60117020x4</b> 607859100		 <b>60139044x8</b> 7301732 8x12x15,2x9,5	
 <b>60117034</b> 5000041255	 <b>60117013</b> 428297200	 <b>60117018x4</b> 5000049389	 <b>60117020x4</b> 607859100		 <b>60139044x8</b> 7301732 8x12x15,2x9,5	

■ : Delik - Çentik

■ : Hole - Notch

■ : Trou - Entaille

NOT: Katalogdaki Orjinal Kodlar Referans Amacıyla Kullanılmıştır.Lütfen COTECH Kodlarını Kullanınız.  
Original codes used for reference only.Please use COTECH codes for orders.

00



Silindir Kapak  
Cylinder Head  
Zylinderkopf  
Joint de culasse

01



02



03



04

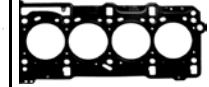

Ltr	MODEL	PS/KW	ENGINE/MOTOR		
1,2 1198	3 CYL ø76,5 FABIA 01/03--> ROOMSTER	70 PS / 51 KW 60 PS / 44 KW	AZQ BME BZG CEVA CGPA CGPB CHTA		 <b>61502005</b> 03E 103 383 F 1,20mm FIBER / FIBRE ø77,5
1,3 1289	4 CYL ø75,5 FAVORIT 115 09/84-->09/94 FAVORIT 136 FELICIA 135 FELICIA 136 FORMAN 136 FAVORIT 135 FORMAN 135 RAPID 130 PICK-UP 781 FAVORIT 781	61 PS / 45 KW 58 PS / 43 KW	135/8 136 L 135 B 136 B AMG AMH OHC	<b>61501001</b> Motor Takım Gasket Set  <b>61501003</b> Üst Takım Gasket Head Set	 <b>61501005</b> 114-092854 1,60mm  <b>61501006</b> 114-092854 2,00mm ø77
1,4 1391	4 CYL ø76,5 FABIA 10/99--> OCTAVIA  OCTAVIA 08/00--> FABIA 06/04--> OCTAVIA ROOMSTER	100 PS / 74 KW 75 PS / 55 KW  75 PS / 55 KW 86 PS / 63 KW 80 PS / 59 KW	AUA AUB AXP BBY BBZ BKY BCA BUD BXW CGGA	<b>61405303</b>	 <b>61405303</b> 036 103 383 AM MLS ø77,5
1,9 1896	4 CYL ø79,5 FELICIA 10/95-->06/01	64 PS / 47 KW	AEY		 <b>61405205</b> 028 103 383 BN 1,61mm 3 ■ <b>61405206</b> 028 103 383 BM 1,53mm 2 ■ <b>61405207</b> 028 103 383 BL 1,45mm 1 ■ MLS ø81

▲ : İçerikte Bulunmamaktadır...

▲ : Not included in the set

▲ : Non inclus dans la pochette

00: Motor Takım Keçesiz ve Subap Lastiksiz











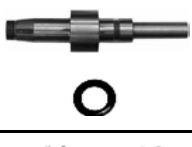
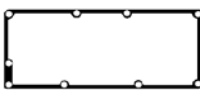

00: Gasket Set Without oil seals Without Valve Stem Seal

01: Motor Takım Keçesiz - Subap Lastikli

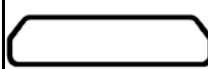
01: Gasket set With Valve Stem Seal Without Oil Seals

02: Motor Full Takım Keçeli ve Subap Lastikli

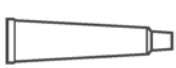
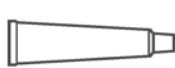
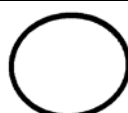
02: Gasket Full Set With oil seals and Valve Stem Seals

Subap Kapak Valve Cover Gasket Zylinderkopfhaube Couvre-culbut.	Karter Oil Pan Ölwanne Carter d'huile	Emme Manifold Intake Manifold Ansaug Admission	Egzoz Manifold Exhaust Manifold Auspuffkrümmer Collecteur D'echappement	Eksoz Boğaz Exhaust Pipe Auspuff Kehle	Supap Keçesi Valve Stem Seal Ventilschaft Queue de soupape	
						
						
61501025 047 103 483	61501013 113-090920	61501020 114-095840	61501017 115690840	60107027x8 113-028540 8x10,8x14,2x10		
						21204029x2 27x42x8 RD
62427465	62427465	61405319x6 036 129 717 E	61405321 036 253 039 F	62457127x16 036 109 675 6x8,8x12,2x9,7		

■ : Delik - Çentik

■ : Hole - Notch

■ : Trou - Entaille

NOT: Katalogdaki Orjinal Kodlar Referans Amacıyla Kullanılmıştır.Lütfen COTECH Kodlarını Kullanınız.  
Original codes used for reference only.Please use COTECH codes for orders.

00  
01  
02  
03  
04



Silindir Kapak  
Cylinder Head  
Zylinderkopf  
Joint de culasse



Ltr	MODEL	PS/KW	ENGINE/MOTOR	
1,6 1588	4 CYL ø80,5 CORONA 02/77-->03/83 HI-LUX HI-ACE TOYO-ACE	67 PS / 49 KW	12R 12R-U/RJ	 <b>61411505</b> 11115-31020 1,80mm  <b>61411506</b> 11115-31020 2,0mm ø83
1,8 1812	4 CYL ø86 TOWN-ACE 03/83-->11/89 LITE-ACE HI-LUX CORONA DYNA 100 MASTER-ACE	79 PS / 58 KW 83 PS / 61 KW	1Y-J 2Y 2YPU	 <b>61411605</b> 11115-71010 1,80mm  <b>61411606</b> 11115-71010 2,0mm ø88
2,0 1998	4 CYL ø86 HI-ACE 01/84-->11/89 HI-LUX CROWN CRESSIDA WAGON DYNA 150	88 PS / 65 KW 78 PS / 57 KW	3Y 3Y-PU	 <b>61411605</b> 11115-71010 1,80mm  <b>61411606</b> 11115-71010 2,0mm ø88
2,0 1998	4 CYL ø86 HI-LUX 16V 04/06-->09/06 INNOVA 16V	133 PS / 98 KW	1TR-FE	 <b>61411805</b> 11115-0C011 1,20mm FIBER / FIBRE  <b>61411806</b> 11115-0C011 2,00mm FIBER / FIBRE  <b>ø88</b>

▲ : İçerikte Bulunmamaktadır...

▲ : Not included in the set

▲ : Non inclus dans la pochette

00: Motor Takım Keçesiz ve Subap Lastiksiz







00: Gasket Set Without oil seals Without Valve Stem Seal

01: Motor Takım Keçesiz - Subap Lastikli

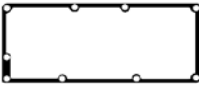
01: Gasket set With Valve Stem Seal Without Oil Seals

02: Motor Full Takım Keçeli ve Subap Lastikli

02: Gasket Full Set With oil seals and Valve Stem Seals

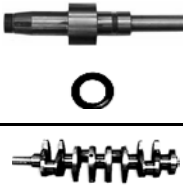
<p>Subap Kapak Valve Cover Gasket Zylinderkopfhaube Couvre-culbut.</p> 	<p>Karter Oil Pan Ölwanne Carter d'huile</p> 	<p>Emme Manifold Intake Manifold Ansaug Admission</p> 	<p>Egzoz Manifold Exhaust Manifold Auspuffkrümmer Collecteur D'echappement</p> 	<p>Eksoz Boğaz Exhaust Pipe Auspuff Kehle</p> 	<p>Supap Keçesi Valve Stem Seal Ventilschaft Queue de soupape</p> 	

■ : Delik - Çentik

■ : Hole - Notch

■ : Trou - Entaille

NOT: Katalogdaki Orijinal Kodlar Referans Amacıyla Kullanılmıştır.Lütfen Cotech Kodlarını Kullanınız.  
Original codes used for reference only.Please use Cotech codes for orders.

00



Silindir Kapak  
Cylinder Head

01



Zylinderkopf

02



Joint de culasse

03



04



Ltr	MODEL	PS/KW	ENGINE/MOTOR	
2,2 2237	4 CYL ø91 TOWN-ACE VAN WAGON STOUT VAN HI-LUX LITE-ACE DYNA 200	01/87-->01/95 98 PS / 72 KW 94 PS / 69 KW	4Y 4Y-EC	<p><b>61411105</b> 11115-73010 1,60mm</p> <p><b>61411106</b> 11115-73010 2,00mm ø93</p>
2,7 2694	4 CYL ø95 HI-LUX 16V INNOVA 16V FORTURNER 16V TACOMA 16V HI-ACE 16V	08/04--> 144 PS / 106 KW 151 PS / 111 KW		<p><b>61411705</b> 11115-0C020 1,20mm FIBER / FIBRE</p> <p><b>61411706</b> 11115-0C020 2,00mm FIBER / FIBRE</p> <p>ø97</p>

▲ : İçerikte Bulunmamaktadır...

▲ : Not included in the set

▲ : Non inclus dans la pochette

00: Motor Takım Keçesiz ve Subap Lastiksiz







00: Gasket Set Without oil seals Without Valve Stem Seal

01: Motor Takım Keçesiz - Subap Lastikli

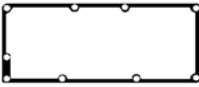
01: Gasket set With Valve Stem Seal Without Oil Seals

02: Motor Full Takım Keçeli ve Subap Lastikli

02: Gasket Full Set With oil seals and Valve Stem Seals

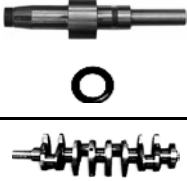
<p>Subap Kapak Valve Cover Gasket Zylinderkopfhaube Couvre-culbut.</p> 	<p>Karter Oil Pan Ölwanne Carter d'huile</p> 	<p>Emme Manifold Intake Manifold Ansaug Admission</p> 	<p>Egzoz Manifold Exhaust Manifold Auspuffkrümmer Collecteur D'echappement</p> 	<p>Eksoz Boğaz Exhaust Pipe Auspuff Kehle</p> 	<p>Supap Keçesi Valve Stem Seal Ventilschaft Queue de soupape</p> 	

■ : Delik - Çentik

■ : Hole - Notch

■ : Trou - Entaille

NOT: Katalogdaki Orijinal Kodlar Referans Amacıyla Kullanılmıştır.Lütfen COTECH Kodlarını Kullanınız.  
Original codes used for reference only.Please use COTECH codes for orders.

00



Silindir Kapak

Cylinder Head

01



Zylinderkopf

02



Joint de culasse

03



04



Ltr	MODEL	PS/KW	ENGINE/MOTOR		
1,3 1286	<b>4 CYL ø73</b> 66 -->26917	08/75-->11/79 57 PS / 42 KW	B130S B130	▲ <b>60101001</b> Motor Takım Gasket Set  <b>60101002</b> 77 01 452 153	 <b>60101005</b> 77 00 576 242 1,20mm  <b>60101006</b> 77 00 576 242 1,80mm <b>ø74,3</b>
1,3 1286	<b>4 CYL ø73</b> 66 26918-->	08/1975->11/1979 57 PS / 42 KW	B130S B130	<b>60101102</b> 77 01 459 631	 <b>60101005</b> 77 00 576 242 1,20mm  <b>60101006</b> 77 00 576 242 1,80mm <b>ø74,3</b>
1,4 1397	<b>4 CYL ø76</b> 340 343 345 360	08/1975->12/1988 70 PS / 51 KW 63 PS / 46 KW	B 14.3 E B 14.3 S	<b>60102002</b> 3267492-1  ▲ <b>60102001</b>  3267492-1  <b>60102003</b> 3 267 492-1	 <b>60102005</b> 77 00 680 689 1,20mm  <b>60102006</b> 77 00 680 689 1,40mm  <b>60102009</b> 77 00 680 689 1,80mm <b>ø77</b>
1,6 1596	<b>4 CYL ø79</b> S40 16V C30 16V	01/05--> 101 PS / 74 KW	B4164S3		 <b>62218205</b> 30 711 613 1,20mm FIBER / FIBRE <b>ø80</b>

▲ : İçerikte Bulunmamaktadır...

▲ : Not included in the set

▲ : Non inclus dans la pochette

00: Motor Takım Keçesiz ve Subap Lastiksiz











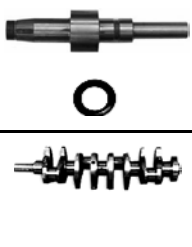
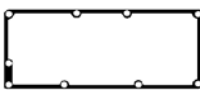





00: Gasket Set Without oil seals Without Valve Stem Seal

01: Motor Takım Keçesiz - Subap Lastikli

01: Gasket set With Valve Stem Seal Without Oil Seals

02: Motor Full Takım Keçeli ve Subap Lastikli

02: Gasket Full Set With oil seals and Valve Stem Seals

Subap Kapak Valve Cover Gasket Zylinderkopfhaube Couvre-culbut.	Karter Oil Pan Ölwanne Carter d'huile	Emme Manifold Intake Manifold Ansaug Admission	Egzoz Manifold Exhaust Manifold Auspuffkrümmer Collecteur D'echappement	Eksoz Boğaz Exhaust Pipe Auspuff Kehle	Supap Keçesi Valve Stem Seal Ventilschaft Queue de soupape	
						
5,00mm <b>60101525</b> 77 00 723 967	 <b>60101265</b> 77 01 453 950	 <b>60101020</b> 77 00 559 702		 <b>60101017</b> 77 00 502 706	▲	<b>21201011</b> 35x50x8 RD <b>21201031</b> 70x90x10 LD
5,00mm <b>60101525</b> 77 00 723 967	 <b>60101265</b> 77 01 453 950	 <b>60101020</b> 77 00 559 702		 <b>60101017</b> 77 00 502 706	▲	<b>21201011</b> 35x50x8 RD <b>21201034</b> 80x100x13 LD
6,5mm <b>60102525</b> 77 01 348 574	 <b>60102265</b> 77 01 457 561	 <b>60101020</b> 77 00 559 702		 <b>60101017</b> 77 00 502 706		▲ <b>21201011</b> 35x50x8 RD ▲ <b>21201034</b> 80x100x13 LD

■ : Delik - Çentik

■ : Hole - Notch

■ : Trou - Entaille





NOT: Katalogdaki Orjinal Kodlar Referans Amacıyla Kullanılmıştır.Lütfen COTECH Kodlarını Kullanınız.  
Original codes used for reference only.Please use COTECH codes for orders.

00  
01  
02  
03  
04

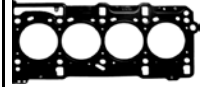

Silindir Kapak  
Cylinder Head  
Zylinderkopf  
Joint de culasse

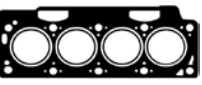

Ltr	MODEL	PS/KW	ENGINE/MOTOR			
1,6 1598	<b>4 CYL ø75</b> C30 D S40 D S80 II D V50 D V70 III D	01/05-->     	110 PS / 81 KW 109 PS / 80 KW	D 4164 T	<p><b>61707002</b> Motor Full Takım Gasket Full Set</p>  <p><b>61707003</b> Motor Üst Takım Gasket Head Set</p>  <p><b>61707004</b> Motor Alt Takım Conversion Set</p>	 <p><b>61707005</b> 30 735 085 1,45mm 5</p> <p><b>61707006</b> 30 735 084 1,40mm 4</p> <p><b>61707007</b> 30 735 082 1,30mm 3</p> <p><b>61707008</b> 30 735 081 1,25mm 2</p> <p><b>61707009</b> 30 735 083 1,35mm 1 MLS ø76</p>
1,7 1721	<b>4 CYL ø81</b> 340-360 440 T 460 T 480 T 440 460 480	08/85-->    04/86-->	122 PS / 90 KW 79 PS / 58 KW  109 PS / 80 KW 79 PS / 58 KW	B 17 2 K B 18 FT B 18 FTM B 18 K B 18 E B 18 ED B 18 EP B 18 F B 18 FP B 18 KD B 18 KP B 18 KPD	 <p><b>60107005</b> 3 344 303-7 1,40mm</p> <p><b>60107007</b> 3 344 303-7 1,60mm ø82</p>	
1,8 1794	<b>4 CYL ø82,2</b> 440 460	08/91-->12/96	90 PS / 66 KW	B 18 U	 <p><b>60134005</b> 3 467 605 1,20mm</p> <p><b>60134007</b> 3 467 605 1,60mm ø83,7</p>	

▲ : İçerikte Bulunmamaktadır...

▲ : Not included in the set

▲ : Non inclus dans la pochette

00: Motor Takım Keçesiz ve Subap Lastiksiz











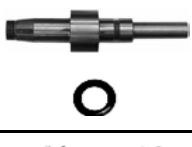
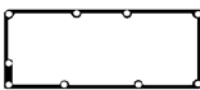



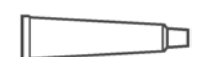

00: Gasket Set Without oil seals Without Valve Stem Seal

01: Motor Takım Keçesiz - Subap Lastikli

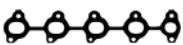
01: Gasket set With Valve Stem Seal Without Oil Seals

02: Motor Full Takım Keçeli ve Subap Lastikli

02: Gasket Full Set With oil seals and Valve Stem Seals

Subap Kapak Valve Cover Gasket Zylinderkopfhaube Couvre-culbut.	Karter Oil Pan Ölwanne Carter d'huile	Emme Manifold Intake Manifold Ansaug Admission	Egzoz Manifold Exhaust Manifold Auspuffkrümmer Collecteur D'echappement	Eksoz Boğaz Exhaust Pipe Auspuff Kehle	Supap Keçesi Valve Stem Seal Ventilschaft Queue de soupape	
						
 <b>61707025</b> 30 735 093	 <b>62427465</b>	 30 711 091 x4  30 711 090 x4 <b>61707018</b> 0348.R5+0348.R4 <b>SET</b>	 <b>61706021</b> 30 711 093		 <b>61707026x16</b> 30 711 502 <b>5,5x9,5x18,1x14</b>	<b>21204017</b> 27x47x7 RD <b>21204018</b> 40x55x6,4 LD <b>21204019</b> 85x105x8,8 RD
 <b>60104525</b> 77 00 719 666		 <b>60107021</b> 77 00 725 397				
 <b>60104525</b> 77 00 719 666	 <b>60113265</b> 77 00 859 751	 <b>60134021</b> 77 00 854 539				

■ : Delik - Çentik

■ : Hole - Notch

■ : Trou - Entaille

NOT: Katalogdaki Orjinal Kodlar Referans Amacıyla Kullanılmıştır.Lütfen COTECH Kodlarını Kullanınız.  
Original codes used for reference only.Please use COTECH codes for orders.

00



01



02



03



04



Silindir Kapak  
Cylinder Head  
Zylinderkopf  
Joint de culasse



Ltr	MODEL	PS/KW	ENGINE/MOTOR		
1,9 1870	4 CYL ø80 S40 TD V40 TD 440 TD 460 TD 07/94-->	94 PS / 69 KW 90 PS / 66 KW	D 19 T D 4192 T F8Q 768		<p><b>60152005</b> 3 345 350 1,60mm 3 <b>M</b></p> <p><b>60152006</b> 3 345 349 1,50mm 1 <b>M</b></p> <p><b>60152007</b> 3 345 348 1,40mm 2 <b>M</b></p> <p>ø81</p>
1,9 1870	4 CYL ø80 S40 DI V40 DI 03/99-->07/00	95 PS / 70 KW	D 4192 T2	<p><b>60152102</b> Motor Takım Gasket Set</p> <p><b>60152103</b> 77 01 470 288</p> <p><b>60152104</b> 77 01 470 176</p>	<p><b>60152105</b> 30 889 391 1,45mm 1 <b>M</b></p> <p><b>60152106</b> 30 889 390 1,35mm 2 <b>M</b></p> <p><b>60152107</b> 30 889 392 1,55mm 3 <b>M</b></p> <p>FIBER / FIBRE ø81</p>
1,9 1870	4 CYL ø80 S40 DI V40 DI 07/00-->06/04	115 PS / 85 KW 102 PS / 75 KW	D 4192 T3 D 4192 T4	<p><b>60152102</b> Motor Takım Gasket Set</p> <p><b>60152103</b> 77 01 470 288</p> <p><b>60152104</b> 77 01 470 176</p>	<p><b>60152205</b> 31 216 523 1,32mm</p> <p><b>60152206</b> 82 00 780 116 1,60mm MLS ø81</p>

▲ : İçerikte Bulunmamaktadır...

▲ : Not included in the set

▲ : Non inclus dans la pochette

00: Motor Takım Keçesiz ve Subap Lastiksiz











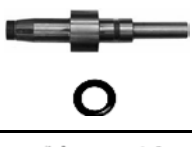
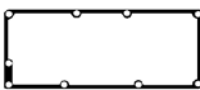

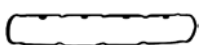

00: Gasket Set Without oil seals Without Valve Stem Seal

01: Motor Takım Keçesiz - Subap Lastikli

01: Gasket set With Valve Stem Seal Without Oil Seals

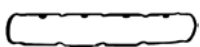
02: Motor Full Takım Keçeli ve Subap Lastikli

02: Gasket Full Set With oil seals and Valve Stem Seals

Subap Kapak Valve Cover Gasket Zylinderkopfhaube Couvre-culbut.	Karter Oil Pan Ölwanne Carter d'huile	Emme Manifold Intake Manifold Ansaug Admission	Egzoz Manifold Exhaust Manifold Auspuffkrümmer Collecteur D'echappement	Eksoz Boğaz Exhaust Pipe Auspuff Kehle	Supap Keçesi Valve Stem Seal Ventilschaft Queue de soupape	
						
						<b>21204002</b> 25x42x8 RD
<b>60152025</b> 30 621 277	<b>60152065</b> 31 251 147	<b>60152121</b> 30 750 740			<b>60116026x8</b> 3 517 893 7x9,8/13.2x10	<b>21204014</b> 42x54x6 RD
						<b>21208011</b> 85x105x11 LD
						<b>21204002</b> 25x42x8 RD
<b>60152025</b> 30 621 277	<b>60152065</b> 31 251 147	<b>60152121</b> 30 750 740			<b>60116026x8</b> 3 517 893 7x9,8/13.2x10	<b>21204014</b> 42x54x6 RD
						<b>21208011</b> 85x105x11 LD

■ : Delik - Çentik

■ : Hole - Notch

■ : Trou - Entaille

NOT: Katalogdaki Orijinal Kodlar Referans Amacıyla Kullanılmıştır.Lütfen COTECH Kodlarını Kullanınız.  
Original codes used for reference only.Please use COTECH codes for orders.

00



Silindir Kapak

Cylinder Head

01



Zylinderkopf

02



Joint de culasse

03



04

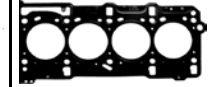

Ltr	MODEL	PS/KW	ENGINE/MOTOR		
2,0 1986	<b>4 CYL ø89</b> 240 340-360 740 740 T 940 940 T  240 340 360 740	08/83-->10/98        08/80-->08/90	189 PS / 139 KW 109 PS / 80 KW      105 PS/ 77 KW 95 PS / 70 KW	B 200 E B 200 EA B 200 ET B 200 F B 200 FT B 200 G B 200 GT B 200 K B 200 K B 200 K B 200 K	 <b>61405005</b> 1 378 645-1 1,30mm <b>ø95</b>
2,0 1998	<b>4 CYL ø82,2</b> 440 460 480	08/92-->07/96	110 PS / 81 KW 109 PS / 80 KW	B 20 F	 <b>60134005</b> 3 467 605 1,20mm  <b>60134007</b> 3 467 605 1,60mm <b>ø83,7</b>
2,0 1999	<b>4 CYL ø87,5</b> C30 S40 S40 II S80 II V50 V70	10/06-->	146 PS / 107 KW 145 PS / 107 KW	B 4204 S3 B 4204 S4	 <b>61420405</b> 30777325 1,20mm FIBER / FIBRE  <b>ø89</b>

▲ : İçerikte Bulunmamaktadır...

▲ : Not included in the set

▲ : Non inclus dans la pochette

00: Motor Takım Keçesiz ve Subap Lastiksiz









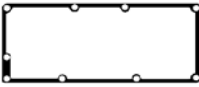

00: Gasket Set Without oil seals Without Valve Stem Seal

01: Motor Takım Keçesiz - Subap Lastikli

01: Gasket set With Valve Stem Seal Without Oil Seals

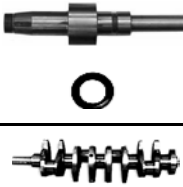
02: Motor Full Takım Keçeli ve Subap Lastikli

02: Gasket Full Set With oil seals and Valve Stem Seals

<p>Subap Kapak Valve Cover Gasket Zylinderkopfhaube Couvre-culbut.</p> 	<p>Karter Oil Pan Ölwanne Carter d'huile</p> 	<p>Emme Manifold Intake Manifold Ansaug Admission</p> 	<p>Egzoz Manifold Exhaust Manifold Auspuffkrümmer Collecteur D'echappement</p> 	<p>Eksoz Boğaz Exhaust Pipe Auspuff Kehle</p> 	<p>Supap Keçesi Valve Stem Seal Ventilschaft Queue de soupape</p> 	
 <p><b>60104525</b> 77 00 719 666</p>	 <p><b>60113265</b> 77 00 859 751</p>	 <p><b>60134021</b> 77 00 854 539</p>				

■ : Delik - Çentik

■ : Hole - Notch

■ : Trou - Entaille

NOT: Katalogdaki Orijinal Kodlar Referans Amacıyla Kullanılmıştır.Lütfen COTECH Kodlarını Kullanınız.  
Original codes used for reference only.Please use COTECH codes for orders.

00



Silindir Kapak  
Cylinder Head  
Zylinderkopf  
Joint de culasse

01



02





03



04



Ltr	MODEL	PS/KW	ENGINE/MOTOR			
<b>2,0</b>	<b>4 CYL ø89</b>					
1986	<b>240</b> 1977-->	117 PS / 86 KW	B19E	<b>61405000</b>		
	<b>242</b> 1977-->	117 PS / 86 KW	B19E	270676-0	<b>61405005</b> 1 378 645-1 1,30mm ø95	
	<b>244</b> 1977-->	117 PS / 86 KW	B19E	270677-8		
	<b>245</b> 1977-->	117 PS / 86 KW	B19E			
	<b>340</b> 08/1982-->07/1984	115 PS / 85 KW	B19E			
	<b>343</b> 08/1982-->07/1984	115 PS / 85 KW	B19E			
	<b>344</b> 08/1982-->07/1984	115 PS / 85 KW	B19E			
	<b>345</b> 08/1982-->07/1984	115 PS / 85 KW	B19E			
	<b>360</b> 1983-->	117 PS / 86 KW	B19E			
	<b>740</b> 1983-->	117 PS / 86 KW	B19E			
	<b>760</b> 1983-->	117 PS / 86 KW	B19E			
	<b>240</b> 1977-->	90 PS / 66 KW	B19A			
	<b>242</b> 1977-->	90 PS / 66 KW	B19A			
	<b>244</b> 1977-->	90 PS / 66 KW	B19A			
	<b>245</b> 1977-->	90 PS / 66 KW	B19A			
	<b>340</b> 08/1983->07/1984	92 PS / 68 KW	B19A			
	<b>343</b> 1977-->	90 PS / 66 KW	B19A			
	<b>344</b> 08/1983->07/1984	92 PS / 68 KW	B19A			
	<b>345</b> 1977-->	90 PS / 66 KW	B19A			
	GLE					
	GLS					
	DLS					
<b>2,1</b>	<b>4 CYL ø92</b>					
2127	<b>240</b> 08/1975->07/1984	107 PS / 79 KW	B21 A	<b>61405000</b>		
	<b>240</b> 08/1980->07/1985	155 PS / 114 KW	B21 ET	270676-0	<b>61405005</b> 1 378 645-1 1,30mm ø95	
	<b>240</b> 08/1980->07/1984	107 PS / 79 KW	B21 F	270677-8		
	<b>242</b> 08/1980->07/1985	155 PS / 114 KW	B21 ET			
	<b>242</b> 08/1975->07/1984	107 PS / 79 KW	B21 A			
	<b>242</b> 1975--->	136 PS / 100 KW	B21E/F/T			
	<b>242</b> 1975--->	136 PS / 100 KW	B21E/F/T			
	<b>244</b> 1975--->	136 PS / 100 KW	B21E/F/T			
	<b>244</b> 08/1975->07/1984	107 PS / 79 KW	B21 A			
	<b>244</b> 08/1980->07/1985	155 PS / 114 KW	B21 ET			
	<b>245</b> 08/1975->07/1984	107 PS / 79 KW	B21 A			
	<b>245</b> 1975--->	136 PS / 100 KW	B21E/F/T			
	<b>440</b> 08/1993-->09/1995	110 PS / 80 KW	B21E			
	<b>445</b> 08/1993-->09/1995	110 PS / 80 KW	B21E			
	<b>460</b> 08/1993-->09/1995	110 PS / 80 KW	B21E			
	<b>464</b> 08/1993-->09/1995	110 PS / 80 KW	B21E			
	<b>740</b> 1975--->	136 PS / 100 KW	B21E/F/T			
	<b>760</b> 1975--->	136 PS / 100 KW	B21E/F/T			
	GLE					
	<b>240</b> 08/1974-->07/1984	97 PS / 71 KW 107 PS / 79 KW	B21 A			

▲ : İçerikte Bulunmamaktadır...

▲ : Not included in the set

▲ : Non inclus dans la pochette

00: Motor Takım Keçesiz ve Subap Lastiksiz











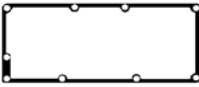





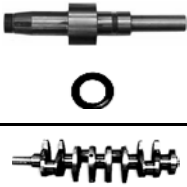
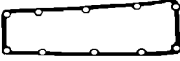

00: Gasket Set Without oil seals Without Valve Stem Seal

01: Motor Takım Keçesiz - Subap Lastikli

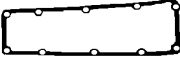
01: Gasket set With Valve Stem Seal Without Oil Seals

02: Motor Full Takım Keçeli ve Subap Lastikli

02: Gasket Full Set With oil seals and Valve Stem Seals

<p>Subap Kapak Valve Cover Gasket Zylinderkopfhaube Couvre-culbut.</p> 	<p>Karter Oil Pan Ölwanne Carter d'huile</p> 	<p>Emme Manifold Intake Manifold Ansaug Admission</p> 	<p>Egzoz Manifold Exhaust Manifold Auspuffkrümmer Collecteur D'echappement</p> 	<p>Eksoz Boğaz Exhaust Pipe Auspuff Kehle</p> 	<p>Supap Keçesi Valve Stem Seal Ventilschaft Queue de soupape</p> 	
 <p><b>61406034</b> 1378909-4</p>  <p><b>61406035</b> 463416-8</p>	 <p><b>61406013</b> 1378864-1</p>	 <p><b>61406019</b> 1378879-9</p>	 <p><b>61406020x4</b> 1378217-2</p>	 <p><b>61406017</b> 1266713-5</p>		
 <p><b>61406034</b> 1378909-4</p>  <p><b>61406035</b> 463416-8</p>	 <p><b>61406013</b> 1378864-1</p>	 <p><b>61406019</b> 1378879-9</p>	 <p><b>61406020x4</b> 1378217-2</p>	 <p><b>61406017</b> 1266713-5</p>		

■ : Delik - Çentik

■ : Hole - Notch

■ : Trou - Entaille

NOT: Katalogdaki Orjinal Kodlar Referans Amacıyla Kullanılmıştır.Lütfen COTECH Kodlarını Kullanınız.  
Original codes used for reference only.Please use COTECH codes for orders.

00



Silindir Kapak

Cylinder Head

01



Zylinderkopf

02



Joint de culasse

03



04



Ltr	MODEL	PS/KW	ENGINE/MOTOR		
2,3 2316	<b>4 CYL ø96</b> 240 08/1978-->12/1988 242 1978--> 244 1978--> 244 08/1978-->12/1988 245 1978--> 740 1978--> 760 1978--> 240 08/1980-->07/1984 242 1981--> 244 08/1979-->07/1984 245 08/1980-->07/1984 740 08/1984-->07/1990 744 08/1984-->07/1990	136 PS / 100 KW 136 PS / 100 KW 136 PS / 100 KW 136 PS / 100 KW 136 PS / 100 KW 136 PS / 100 KW 136 PS / 100 KW 112 PS / 82 KW 112 PS / 82 KW 112 PS / 82 KW 112 PS / 82 KW 112 PS / 82 KW 114 PS / 84 KW	B23E/F/T B23E/F/T B23E/F/T B23E/F/T B23E/F/T B23E/F/T B23E/F/T B23A B23A B23A B23A B23A B23A	<b>61406000</b> 270684-4 270685-1	 <b>61406005</b> 1378646-2 1,50mm ø98
2,3 2316	<b>4 CYL ø96</b> 240 08/84-->07/86 740 240 08/83-->10/98 740 740 T 760 760 T 940 940 T  740 08/87-->08/92 940	112 PS / 82 KW 110 PS / 81 KW 190 PS / 140 KW 113 PS / 83 KW  159 PS / 117 KW 151 PS / 111 KW	B 230 A B 230 E B 230 ET B 230 F B 230 FB B 230 FD B 230 FK B 230 FT B 230 FT+ B 230 G B 230 GK B 230 GT B 230 K B 234 F B 234 G		 <b>61406005</b> 1378646-2 1,50mm ø98
2,7 2664	<b>6 CYL ø88</b> 260 08/75-->07/82 240 08/74-->07/82 260	125 PS / 92 KW 148 PS / 109 KW 140 PS / 103 KW	B 27 A B 27 E B 27 F		 245 291-0 1,20mm  245 585-5 1,20mm ø90 <b>60115005</b>

▲ : İçerikte Bulunmamaktadır...

▲ : Not included in the set

▲ : Non inclus dans la pochette

00: Motor Takım Keçesiz ve Subap Lastiksiz











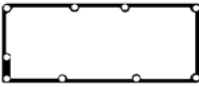

00: Gasket Set Without oil seals Without Valve Stem Seal

01: Motor Takım Keçesiz - Subap Lastikli

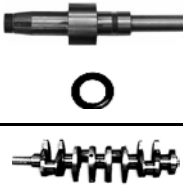
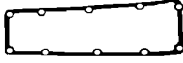
01: Gasket set With Valve Stem Seal Without Oil Seals

02: Motor Full Takım Keçeli ve Subap Lastikli

02: Gasket Full Set With oil seals and Valve Stem Seals

<p>Subap Kapak Valve Cover Gasket Zylinderkopfhaube Couvre-culbut.</p> 	<p>Karter Oil Pan Ölwanne Carter d'huile</p> 	<p>Emme Manifold Intake Manifold Ansaug Admission</p> 	<p>Egzoz Manifold Exhaust Manifold Auspuffkrümmer Collecteur D'echappement</p> 	<p>Eksoz Boğaz Exhaust Pipe Auspuff Kehle</p> 	<p>Supap Keçesi Valve Stem Seal Ventilschaft Queue de soupape</p> 	
 <p><b>61406034</b> 1378909-4</p>  <p><b>61406035</b> 463416-8</p>	 <p><b>61406013</b> 1378864-1</p>	 <p><b>61406019</b> 1378879-9</p>	 <p><b>61406020x4</b> 1378217-2</p>	 <p><b>61406017</b> 1266713-5</p>		

■ : Delik - Çentik

■ : Hole - Notch

■ : Trou - Entaille

NOT: Katalogdaki Orijinal Kodlar Referans Amacıyla Kullanılmıştır.Lütfen COTECH Kodlarını Kullanınız.  
Original codes used for reference only.Please use COTECH codes for orders.

00



Silindir Kapak

Cylinder Head

01



Zylinderkopf

02



Joint de culasse

03



04

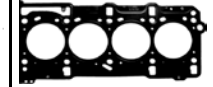

Ltr	MODEL	PS/KW	ENGINE/MOTOR		
1,0 999	<b>4 CYL ø67</b> POLO FOX 02/03-->10/03 10/03-->	79 PS / 58 KW 73 PS / 54 KW 65 PS / 48 KW	ARA AQZ AZN BJE BJR BNW BNX BTY CCNA		 <b>61415005</b> 036 103 383 AF 1,20mm FIBER / FIBRE <b>ø68</b>
1,4 1390	<b>4 CYL ø76,5</b> BORA CADDY GOLF LUPO POLO 08/97-->  GOLF POLO 05/06-->	101 PS / 74 KW 74 PS / 55 KW 80 PS / 59 KW  85 PS / 63 KW 80 PS / 59 KW	AFK AHW AKQ ANM APE AQQ AUA AUB AXP BBY BBZ BCA BCC BKY BUD CGGA CGGB CMAA	<b>61405303</b>	 <b>61405305</b> 036 103 383 AM <b>MLS</b> <b>ø77,5</b>
1,5 1457	<b>4 CYL ø79,5</b> CADDY GOLF JETTA SCIROCCO 08/77-->02/84	70 PS / 51 KW	GH JB	<b>61401002</b> 049 198 001 C  <b>61401003</b> 049 198 012 H  <b>61401004</b> 037 198 011 C	 <b>61401005</b> 049 103 383 K 1,60mm <b>ø81</b>

▲ : İçerikte Bulunmamaktadır...

▲ : Not included in the set

▲ : Non inclus dans la pochette

00: Motor Takım Keçesiz ve Subap Lastiksiz











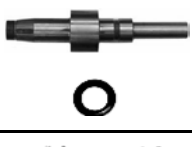
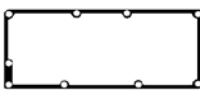



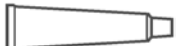
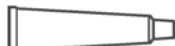

00: Gasket Set Without oil seals Without Valve Stem Seal

01: Motor Takım Keçesiz - Subap Lastikli

01: Gasket set With Valve Stem Seal Without Oil Seals

02: Motor Full Takım Keçeli ve Subap Lastikli

02: Gasket Full Set With oil seals and Valve Stem Seals

Subap Kapak Valve Cover Gasket Zylinderkopfhaube Couvre-culbut.	Karter Oil Pan Ölwanne Carter d'huile	Emme Manifold Intake Manifold Ansaug Admission	Egzoz Manifold Exhaust Manifold Auspuffkrümmer Collecteur D'echappement	Eksoz Boğaz Exhaust Pipe Auspuff Kehle	Supap Keçesi Valve Stem Seal Ventilschaft Queue de soupape	
						
						<b>21204029x2</b> 27x42x8 RD
<b>62427465</b>	<b>62427465</b>	<b>61405319x6</b> 036 129 717 E	<b>61405321</b> 036 253 039 F		<b>62457127x16</b> 036 109 675 6x8,8x12,2x9,7	
						<b>21201075x3</b> 32x47x10 W
<b>61401034</b> 026 198 025 A	<b>61401013</b> 028 103 609 A	<b>61401019</b> 026 129 717 D	<b>61401021x4</b> 026 129 589 A 056 129 589 B	<b>61401017</b> 841 253 115 B	<b>60107027x8</b> 026 109 675 8x10,8/14,2x10	<b>21204504</b> 85x105x12 LD

■ : Delik - Çentik

■ : Hole - Notch

■ : Trou - Entaille

NOT: Katalogdaki Orijinal Kodlar Referans Amacıyla Kullanılmıştır.Lütfen COTECH Kodlarını Kullanınız.  
Original codes used for reference only.Please use COTECH codes for orders.

00



01



02



03



04



Silindir Kapak  
Cylinder Head  
Zylinderkopf  
Joint de culasse



Ltr	MODEL	PS/KW	ENGINE/MOTOR		
1,6 1588	4 CYL ø76,5 GOLF D 08/80-->07/85 GOLF TD JETTA D JETTA TD PASSAT D PASSAT TD SANTANA D SANTANA TD TRANSPORTER DASHER D CADDY D	54 PS / 40 KW 70 PS / 51 KW 54 PS / 40 KW 70 PS / 51 KW 54 PS / 40 KW 70 PS / 51 KW 54 PS / 40 KW 70 PS / 51 KW 70 PS / 51 KW 54 PS / 40 KW 54 PS / 40 KW	CR ; JK ; JP ; JR CR ; JK ; JP ; JR CR ; JK ; JP ; JR CR ; JK ; JP ; JR CR ; JK ; CY CR ; JK ; CY CR ; JK ; CY CR ; JK ; CY CS ; JX JF CR ; JK ; JP	61402002 Motor Full Takım Gasket Full Set  61402003 068 198 012 L 068 198 012 E 033 198 012 A  61402004 037 198 011 C	 61402005 068 103 383 FN 1,60mm 3 M 61402006 068 103 383 FM 1,50mm 2 M 61402007 068 103 383 FL 1,40mm 1 M ø78,5
1,6 1588	4 CYL ø76,5 GOLF D 08/85-->07/93 GOLF TD JETTA D JETTA TD PASSAT D PASSAT TD SANTANA D SANTANA TD CADDY D TRANSPORTER	70 PS / 51 KW 80 PS / 59 KW 70 PS / 51 KW 80 PS / 59 KW 70 PS / 51 KW 80 PS / 59 KW 70 PS / 51 KW 80 PS / 59 KW 54 PS / 40 KW 70 PS / 51 KW	CR ; ME ; JK ; JP ; 1V CR ; JR ; RA ; SB CR ; ME ; SV ; JK ; JP ; 1V CR ; JK ; JR ; RA ; SB ; SV ; 1V CY ; JK ; JP ; RA ; SB CY ; JK ; JP ; RA ; SB CY ; JK ; JP CY ; JK ; JP CR ; ME ; JK CS ; JX	61402002 Motor Full Takım Gasket Full Set  61402003 068 198 012 L 068 198 012 E 033 198 012 A  61402004 037 198 011 C	 61403005 068 103 383 EK 1,61mm 3 M 61403006 068 103 383 EJ 1,57mm 2 M 61403007 068 103 383 EH 1,53mm 1 M ø78,5
1,6 1595	4 CYL ø81 CADDY 01/83-->07/92 GOLF JETTA PASSAT SCIROCCO	75 PS / 55 KW 70 PS / 51 KW	EW EWA EZ EZA HM HN PN RE RF 1F	61408002 Motor Full Takım Gasket Full Set 61408003 027 198 012 L 61402004 037 198 011 C	 61408005 026 103 383 P 026 103 383 L 026 103 383 M 026 103 383 N 026 103 383 K 1,75mm ø83

▲ : İçerikte Bulunmamaktadır...

▲ : Not included in the set

▲ : Non inclus dans la pochette

00: Motor Takım Keçesiz ve Subap Lastiksiz











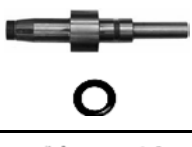
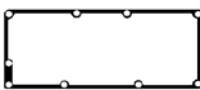







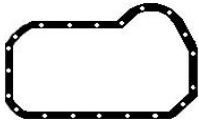





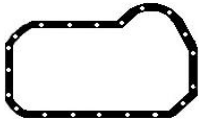

00: Gasket Set Without oil seals Without Valve Stem Seal

01: Motor Takım Keçesiz - Subap Lastikli

01: Gasket set With Valve Stem Seal Without Oil Seals

02: Motor Full Takım Keçeli ve Subap Lastikli

02: Gasket Full Set With oil seals and Valve Stem Seals

Subap Kapak Valve Cover Gasket Zylinderkopfhaube Couvre-culbut.	Karter Oil Pan Ölwanne Carter d'huile	Emme Manifold Intake Manifold Ansaug Admission	Egzoz Manifold Exhaust Manifold Auspuffkrümmer Collecteur D'echappement	Eksoz Boğaz Exhaust Pipe Auspuff Kehle	Supap Keçesi Valve Stem Seal Ventilschaft Queue de soupape	
						
 <b>61401034</b> 026 103 483 026 103 483 B 026 103 483 C 056 103 483 D	 <b>61401013</b> 028 103 609 A 034 129 717 C	 <b>61401019</b> 026 129 717D  <b>61402019</b> 068 129 717 E	 <b>61401021x4</b> 026 129 589 A 028 129 589 B	 <b>61401017</b> 841 253 115 B	 <b>60107027x8</b> 026 109 675 <b>8x10,8/14,2x10</b>	<b>21201075x3</b> 32x47x10 WD  <b>21204504</b> 85x105x12 LD
 <b>61401034</b> 026 103 483 026 103 483 B 026 103 483 C 056 103 483 D	 <b>61401013</b> 028 103 609 A 034 129 717 C	 <b>61401019</b> 026 129 717D  <b>61402019</b> 068 129 717 E	 <b>61401021x4</b> 026 129 589 A 028 129 589 B	 <b>61401017</b> 841 253 115 B	 <b>60107027x8</b> 026 109 675 <b>8x10,8/14,2x10</b>	<b>21201075x3</b> 32x47x10 WD  <b>21204504</b> 85x105x12 LD
 <b>61401034</b> 026 103 483 026 103 483 B 026 103 483 C 056 103 483 D	 <b>61401013</b> 028 103 609 A 034 129 717 C	 <b>61401019</b> 026 129 717D	 <b>61401021x4</b> 026 129 589 A 028 129 589 B	 <b>61401017</b> 841 253 115 B	 <b>60107027x8</b> 026 109 675 <b>8x10,8/14,2x10</b>	<b>21201075x3</b> 32x47x10 WD  <b>21204504</b> 85x105x12 LD

■ : Delik - Çentik

■ : Hole - Notch

■ : Trou - Entaille

NOT: Katalogdaki Orijinal Kodlar Referans Amacıyla Kullanılmıştır.Lütfen COTECH Kodlarını Kullanınız.  
Original codes used for reference only.Please use COTECH codes for orders.

00



Silindir Kapak  
Cylinder Head

01



Zylinderkopf

02



Joint de culasse

03



04



Ltr	MODEL	PS/KW	ENGINE/MOTOR		
1,6 1588	<b>4 CYL ø79,5</b> GOLF GTI 06/76--> PASSAT SCIROCCO CADDY 08/75-->03/88 GOLF JETTA PASSAT SANTANA SCIROCCO  PASSAT 08/75--> SCIROCCO	110 PS / 81 KW 81 PS / 60 KW  85 PS / 63 KW 75 PS / 55 KW  85 PS / 63 KW 65 PS / 48 KW	EG YH YS EM FP FR WV WY YN YP FN FR FT FV WP YN YP YY	<b>61401002</b> 049 198 001 C  <b>61401003</b> 049 198 012 H  <b>61401004</b> 037 198 011 C	 <b>61401005</b> 049 103 383 K 1,60mm ø81
1,6 1598	<b>4 CYL ø76,5</b> GOLF 09/92-->09/98 VENTO	75 PS / 55 KW	ABU		 <b>61400305</b> 032 103 383 G 032 103 383 H 1,60mm ø77,5
1,7 1716	<b>4 CYL ø79,5</b> TRANSPORTER 08/85-->07/92	57 PS / 42 KW	KY	<b>61402002</b> Motor Full Takım Gasket Full Set  <b>61402003</b> 068 198 012 L 068 198 012 E 033 198 012 A  <b>61402004</b> 037 198 011 C	 <b>61404005</b> 033 103 383 M 1,61mm 3 <b>61404006</b> 033 103 383 L 1,57mm 2 <b>61404007</b> 033 103 383 K 1,53mm 1 ø81

▲ : İçerikte Bulunmamaktadır...

▲ : Not included in the set

▲ : Non inclus dans la pochette

00: Motor Takım Keçesiz ve Subap Lastiksiz











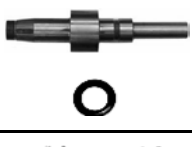
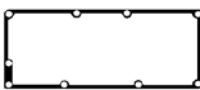









00: Gasket Set Without oil seals Without Valve Stem Seal

01: Motor Takım Keçesiz - Subap Lastikli

01: Gasket set With Valve Stem Seal Without Oil Seals

02: Motor Full Takım Keçeli ve Subap Lastikli

02: Gasket Full Set With oil seals and Valve Stem Seals

Subap Kapak Valve Cover Gasket Zylinderkopfhaube Couvre-culbut.	Karter Oil Pan Ölwanne Carter d'huile	Emme Manifold Intake Manifold Ansaug Admission	Egzoz Manifold Exhaust Manifold Auspuffkrümmer Collecteur D'echappement	Eksoz Boğaz Exhaust Pipe Auspuff Kehle	Supap Keçesi Valve Stem Seal Ventilschaft Queue de soupape	
						
 <b>61401034</b> 026 198 025 A	 <b>61401013</b> 028 103 609 A	 <b>61401019</b> 026 129 717 D	 <b>61401021x4</b> 026 129 589 A 056 129 589 B	 <b>61401017</b> 841 253 115 B	 <b>60107027x8</b> 026 109 675 <b>8x10,8/14,2x10</b>	<b>21201075x3</b> 32x47x10 W  <b>21204504</b> 85x105x12 LD
 <b>61401034</b> 026 103 483 026 103 483 B 026 103 483 C 056 103 483 D	 <b>61401013</b> 028 103 609 A 034 129 717 C	 <b>61402019</b> 068 129 717 E  <b>61401019</b> 026 129 717D	 <b>61401021x4</b> 026 129 589 A 028 129 589 B	 <b>61401017</b> 841 253 115 B	 <b>60107027x8</b> 026 109 675 <b>8x10,8/14,2x10</b>	<b>21201075x3</b> 32x47x10 WD  <b>21204504</b> 85x105x12 LD

■ : Delik - Çentik

■ : Hole - Notch

■ : Trou - Entaille

NOT: Katalogdaki Orijinal Kodlar Referans Amacıyla Kullanılmıştır.Lütfen COTECH Kodlarını Kullanınız.  
Original codes used for reference only.Please use COTECH codes for orders.

00



01



02



03



04



Silindir Kapak  
Cylinder Head  
Zylinderkopf  
Joint de culasse



Ltr	MODEL	PS/KW	ENGINE/MOTOR		
1,7 1716	<b>4 CYL ø79,5</b> CADDY SDI 07/96-->09/00 POLO SDI 04/97-->10/99 LUPO SDI 08/97-->07/05 POLO SDI 08/97-->07/05 POLO SDI 07/97-->09/01	57 PS / 42 KW 57 PS / 42 KW 60 PS / 44 KW 60 PS / 44 KW 60 PS / 44 KW	AHB AHG AKU AKU AKW		<p><b>61405205</b> 028 103 383 BR 028 103 383 BN 1,61mm 3 ■</p> <p><b>61405206</b> 028 103 383 BQ 028 103 383 BM 1,53mm 2 ■</p> <p><b>61405207</b> 028 103 383 BP 028 103 383 BL 1,45mm 1 ■</p> <p><b>MLS</b> <b>ø81</b></p>
1,8 1812	<b>4 CYL ø86</b> TARO 05/89-->09/94	83 PS / 61 KW	2Y		<p><b>61411605</b> 11115-71010 1,80mm</p> <p><b>61411606</b> 11115-71010 2,0mm <b>ø88</b></p>
1,8 1781	<b>4 CYL ø81</b> CADDY 08/82-->07/93 GOLF GOLF GTI JETTA PASSAT SCIROCCO SCIROCCO GTI	112 PS / 82 KW 84 PS / 62 KW 90 PS / 66 KW 98 PS / 72 KW	EV EX GU GX GZ HT HV JH KT RD RG RH RP RV 1P PB PF 2H	<p><b>61408002</b> Motor Full Takım Gasket Full Set</p> <p><b>61408003</b> 027 198 012 L</p> <p><b>61402004</b> 037 198 011 C</p>	<p><b>61408005</b> 026 103 383 P 026 103 383 L 026 103 383 M 026 103 383 N 026 103 383 K 1,75mm <b>ø83</b></p>

00: Motor Takım Keçesiz ve Subap Lastiksiz

01: Motor Takım Keçesiz - Subap Lastikli













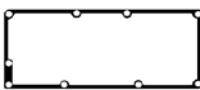

02: Motor Full Takım Keçeli ve Subap Lastikli

307

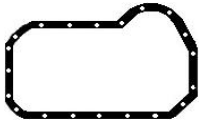
00: Gasket Set Without oil seals Without Valve Stem Seal

01: Gasket set With Valve Stem Seal Without Oil Seals

02: Gasket Full Set With oil seals and Valve Stem Seals

Subap Kapak Valve Cover Gasket Zylinderkopfhaube Couvre-culbut.	Karter Oil Pan Ölwanne Carter d'huile	Emme Manifold Intake Manifold Ansaug Admission	Egzoz Manifold Exhaust Manifold Auspuffkrümmer Collecteur D'echappement	Eksoz Boğaz Exhaust Pipe Auspuff Kehle	Supap Keçesi Valve Stem Seal Ventilschaft Queue de soupape	  
						
						
<b>61401034</b> 026 103 483 026 103 483 B 026 103 483 C 056 103 483 D	<b>61401013</b> 028 103 609 A 034 129 717 C	<b>61401019</b> 026 129 717D	<b>61401021x4</b> 026 129 589 A 028 129 589 B	<b>61401017</b> 841 253 115 B	<b>60107027x8</b> 026 109 675 8x10,8/14,2x10	<b>21201075x3</b> 32x47x10 WD  <b>21204504</b> 85x105x12 LD

■ : Delik - Çentik

■ : Hole - Notch

■ : Trou - Entaille

NOT: Katalogdaki Orijinal Kodlar Referans Amacıyla Kullanılmıştır.Lütfen COTECH Kodlarını Kullanınız.  
Original codes used for reference only.Please use COTECH codes for orders.

00



01



02



03



04



Silindir Kapak  
Cylinder Head  
Zylinderkopf  
Joint de culasse



Ltr	MODEL	PS/KW	ENGINE/MOTOR		
1,8 1781	<b>4 CYL ø81</b> SCIROCCO 16V 09/85-->10/91 JETTA 16V PASSAT 16V CORRADO 16V GOLF 16V PASSAT 08/91-->02/99 GOLF VENTO JETTA GOLF	136 PS / 100 KW 129 PS / 95 KW 90 PS / 66 KW 75 PS / 55 KW	KR JH PL 2H AAM ABS ADZ ADD		 <b>61408005</b> 026 103 383 P 026 103 383 L 026 103 383 M 026 103 383 N 026 103 383 K 1,75mm ø83
1,9 1896	<b>4 CYL ø79,5</b> GOLF TD 03/91-->04/99 PASSAT TD VENTO TD -->AAZ 462 614 TRANSPORTER 07/90-->04/03 -->1X 104 630 CADDY D 05/89-->01/04 GOLF D PASSAT D POLO D VENTO D -->1Y 315 599	75 PS / 55 KW 61 PS / 45 KW 60 PS / 44 KW 68 PS / 50 KW 64 PS / 47 KW	AAZ 1X 1Y	<b>61405102</b> Motor Full Takım Gasket Full Set  <b>61405103</b> 028 198 012 B  <b>61405104</b> 028 198 011 D	 <b>61405105</b> 028 103 383 BD 1,70mm 3 ■ <b>61405106</b> 028 103 383 BC 1,65mm 2 ■ <b>61405107</b> 028 103 383 BB 1,60mm 1 ■ ø81
1,9 1896	<b>4 CYL ø79,5</b> GOLF TDI 03/96-->06/02 PASSAT TDI POLO TDI SHARAN TDI VENTO TDI -->AFN 002 000 CADDY TDI 09/93-->03/10 GOLF TDI PASSAT TDI POLO TDI SHARAN TDI VENTO TDI CADDY TDI 09/93-03/10 GOLF TDI PASSAT TDI SHARAN TDI VENTO TDI -->1Z 770 000	110 PS / 81 KW 115 PS / 85 KW 90 PS / 66 KW	AFN AHU 1Z	<b>61405202</b> Motor Full Takım Gasket Full Set  <b>61405203</b> 028 198 012 C  <b>61405104</b> 028 198 011 D	 <b>61405205</b> 028 103 383 BR 028 103 383 BN 1,61mm 3 ■ <b>61405206</b> 028 103 383 BQ 028 103 383 BM 1,53mm 2 ■ <b>61405207</b> 028 103 383 BP 028 103 383 BL 1,45mm 1 ■ MLS ø81

▲ : İçerikte Bulunmamaktadır...

▲ : Not included in the set

▲ : Non inclus dans la pochette

00: Motor Takım Keçesiz ve Subap Lastiksiz











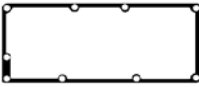

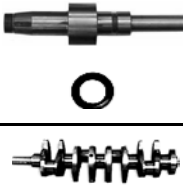
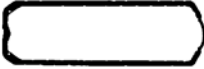

00: Gasket Set Without oil seals Without Valve Stem Seal

01: Motor Takım Keçesiz - Subap Lastikli

01: Gasket set With Valve Stem Seal Without Oil Seals

02: Motor Full Takım Keçeli ve Subap Lastikli

02: Gasket Full Set With oil seals and Valve Stem Seals

<p>Subap Kapak Valve Cover Gasket Zylinderkopfhaube Couvre-culbut.</p> 	<p>Karter Oil Pan Ölwanne Carter d'huile</p> 	<p>Emme Manifold Intake Manifold Ansaug Admission</p> 	<p>Egzoz Manifold Exhaust Manifold Auspuffkrümmer Collecteur D'echappement</p> 	<p>Eksoz Boğaz Exhaust Pipe Auspuff Kehle</p> 	<p>Supap Keçesi Valve Stem Seal Ventilschaft Queue de soupape</p> 	
 <p><b>61405125</b> 028 103 483 F 028 103 483 H  028 103 532 A x3</p>		 <p><b>61405121</b> 028 129 717 D</p>	 <p><b>61401021x4</b> 026 129 589 A 028 129 589 B</p>		 <p><b>60107027x8</b> 026 109 675 <b>8x10,8/14,2x10</b></p>	<p><b>21208042</b> 32x47x10 WD</p> <p><b>21204504</b> 85x105x12 LD</p> <p><b>21208042x2</b> 32x47x10 WD</p>
 <p><b>61405225</b> 028 103 483 C 028 103 483 G  028 103 532 A x3</p>		 <p><b>61405121</b> 028 129 717 D</p>	 <p><b>61401021x4</b> 026 129 589 A 028 129 589 B</p>		 <p><b>60107027x8</b> 026 109 675 <b>8x10,8/14,2x10</b></p>	<p><b>21208042</b> 32x47x10 WD</p> <p><b>21204504</b> 85x105x12 LD</p> <p><b>21208042x2</b> 32x47x10 WD</p>

■ : Delik - Çentik

■ : Hole - Notch

■ : Trou - Entaille

NOT: Katalogdaki Orijinal Kodlar Referans Amacıyla Kullanılmıştır.Lütfen COTECH Kodlarını Kullanınız.  
Original codes used for reference only.Please use COTECH codes for orders.

00



Silindir Kapak

Cylinder Head

01



Zylinderkopf

02



Joint de culasse

03



04

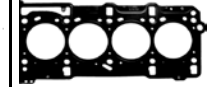

Ltr	MODEL	PS/KW	ENGINE/MOTOR	
1,9 1986	<b>4 CYL ø79,5</b> CADDY SDI 07/95-->01/04 GOLF SDI 07/95-->01/04 POLO SDI 07/95-->01/04 VENTO SDI 07/95-->01/04 POLO SDI 07/96-->09/01 GOLF TDI 09/96-->06/02 PASSAT TDI 09/96-->06/02 SHARAN TDI 09/96-->06/02 CADDY TDI 09/93-->01/04 GOLF TDI 09/93-->01/04 POLO TDI 09/93-->01/04 VENTO TDI 09/93-->01/04 POLO SDI 10/99-->09/01	64 PS / 47 KW 64 PS / 47 KW 64 PS / 47 KW 64 PS / 47 KW 64 PS / 47 KW 110 PS / 81 KW 90 PS / 66 KW 90 PS / 66 KW 90 PS / 66 KW 90 PS / 66 KW 90 PS / 66 KW 90 PS / 66 KW 64 PS / 47 KW	AEY AEY AEY AEY AGD AHH AVG AVG ALE ALE ALE ALE ASX	 <b>61405205</b> 028 103 383 BR 028 103 383 BN 1,61mm 3 ▲ <b>61405206</b> 028 103 383 BQ 028 103 383 BM 1,53mm 2 ▲ <b>61405207</b> 028 103 383 BP 028 103 383 BL 1,45mm 1 ▲ MLS ø81
2,0 1984	<b>4 CYL ø82,5</b> GOLF GTI 08/92-02/00 PASSAT SHARAN -->ABF 031 251 GOLF 02/90-04/99 PASSAT VENTO CORRADO 08/88-12/95 PASSAT	150 PS / 110 KW 115 PS / 85 KW 136 PS / 100 KW	ABF 2E 9A	 <b>61408105</b> 048 103 383 B 1,75mm ø83,5
2,2 2237	<b>4 CYL ø91</b> TARO 06/89-->07/94	94 PS / 69 KW	4Y	 <b>61411105</b> 11115-73010 1,60mm <b>61411106</b> 11115-73010 2,00mm ø93

▲ : İçerikte Bulunmamaktadır...

▲ : Not included in the set

▲ : Non inclus dans la pochette

00: Motor Takım Keçesiz ve Subap Lastiksiz







00: Gasket Set Without oil seals Without Valve Stem Seal

01: Motor Takım Keçesiz - Subap Lastikli

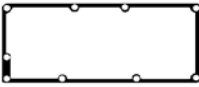
01: Gasket set With Valve Stem Seal Without Oil Seals

02: Motor Full Takım Keçeli ve Subap Lastikli

02: Gasket Full Set With oil seals and Valve Stem Seals

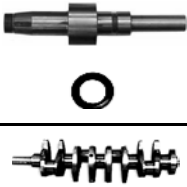
<p>Subap Kapak Valve Cover Gasket Zylinderkopfhaube Couvre-culbut.</p> 	<p>Karter Oil Pan Ölwanne Carter d'huile</p> 	<p>Emme Manifold Intake Manifold Ansaug Admission</p> 	<p>Egzoz Manifold Exhaust Manifold Auspuffkrümmer Collecteur D'echappement</p> 	<p>Eksoz Boğaz Exhaust Pipe Auspuff Kehle</p> 	<p>Supap Keçesi Valve Stem Seal Ventilschaft Queue de soupape</p> 	

■ : Delik - Çentik

■ : Hole - Notch

■ : Trou - Entaille

NOT: Katalogdaki Orijinal Kodlar Referans Amacıyla Kullanılmıştır.Lütfen COTECH Kodlarını Kullanınız.  
Original codes used for reference only.Please use COTECH codes for orders.

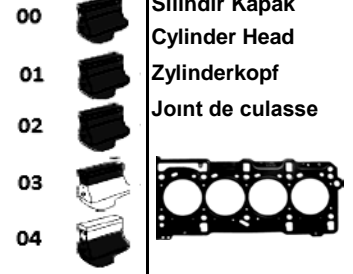

Ltr	MODEL	PS/KW	ENGINE/MOTOR		
<b>2,4</b>					
2370	<b>TRANSPORTER</b> 07/90-->09/98 B70 R 160 001-->	78 PS / 57 KW	AAB	<b>62403002</b>	
	<b>TRANSPORTER</b> 08/97-->04/03	75 PS / 55 KW	AJA	074 198 012 A	
<b>2,5</b>					
2461	<b>TRANSPORTER</b> 09/95-->04/03	102 PS / 75 KW	ACV		
	<b>LT SDI</b> 07/96-->07/06	75 PS / 55 KW	AGX		
	<b>LT TDI</b> 05/96-->08/99	102 PS / 75 KW	AHD		

▲ : İçerikte Bulunmamaktadır...

▲ : Not included in the set

▲ : Non inclus dans la pochette

00: Motor Takım Keçesiz ve Subap Lastiksiz







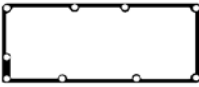
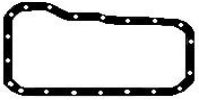

00: Gasket Set Without oil seals Without Valve Stem Seal

01: Motor Takım Keçesiz - Subap Lastikli

01: Gasket set With Valve Stem Seal Without Oil Seals

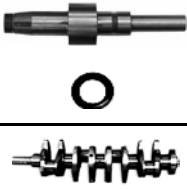
02: Motor Full Takım Keçeli ve Subap Lastikli

02: Gasket Full Set With oil seals and Valve Stem Seals

<p>Subap Kapak Valve Cover Gasket Zylinderkopfhaube Couvre-culbut.</p> 	<p>Karter Oil Pan Ölwanne Carter d'huile</p> 	<p>Emme Manifold Intake Manifold Ansaug Admission</p> 	<p>Egzoz Manifold Exhaust Manifold Auspuffkrümmer Collecteur D'echappement</p> 	<p>Eksoz Boğaz Exhaust Pipe Auspuff Kehle</p> 	<p>Supap Keçesi Valve Stem Seal Ventilschaft Queue de soupape</p> 	
						<p><b>21208042x2</b> 32x47x10 WD</p>
	<p><b>62403013</b> 074 103 609 F</p>	<p><b>62403019</b> 074 129 717</p>	<p><b>62403021x5</b> 026 129 589 A 028 129 589 B</p>		<p><b>60107127x10</b> 026 109 675 <b>8x10,8x14,2x10</b></p>	<p><b>21208026</b> 35x48x10 RD</p>
						<p><b>21204504</b> 85x105x11 LD</p>

■ : Delik - Çentik

■ : Hole - Notch

■ : Trou - Entaille

NOT: Katalogdaki Orijinal Kodlar Referans Amacıyla Kullanılmıştır.Lütfen COTECH Kodlarını Kullanınız.  
Original codes used for reference only.Please use COTECH codes for orders.

00  
01  
02  
03  
04



Silindir Kapak  
Cylinder Head  
Zylinderkopf  
Joint de culasse



Ltr	MODEL	PS/KW	ENGINE/MOTOR		
	4 CYL GAZ 24				 <b>64020005</b> 24-100 30 20 <b>ø92</b>
	4 CYL GAZ 24				 <b>64022005</b> <b>ø100</b> Elipse
	4 CYL GAZ 2401-2405				 <b>64004005</b> 402 1000 3020 <b>ø93</b> Elipse
	4 CYL GAZ 2217 - 2705 -2752 - 3110 3221 -3302				 <b>60004605</b> 406 - 100 30 20 <b>ø97,5</b>
	4 CYL GAZ 406				 <b>60004705</b> <b>ø97,5</b> Elipse
	4 CYL MEMZ - 245 / 2451 / 2457				 <b>64015005</b> 1,40mm

▲ : İçerikte Bulunmamaktadır...

▲ : Not included in the set

▲ : Non inclus dans la pochette

00: Motor Takım Keçesiz ve Subap Lastiksiz

00: Gasket Set Without oil seals Without Valve Stem Seal

01: Motor Takım Keçesiz - Subap Lastikli

01: Gasket set With Valve Stem Seal Without Oil Seals

02: Motor Full Takım Keçeli ve Subap Lastikli

02: Gasket Full Set With oil seals and Valve Stem Seals

